

Series KTU9 UL489 Molded Case Circuit Breakers

Versatile, convenient
and space saving...
for a variety of
applications

Sprecher+Schuh's KTU9 series of UL Molded Case Circuit Breakers are UL489 and CE listed for global applications. The current limiting circuit breaker provides fixed short circuit and overcurrent protection and offers high interrupting ratings for 2- and 3-pole devices from 0.5 to 40A. These Circuit breakers are 100% rated up to 10A.

Accessories are intelligently designed to be field installed. The compact busbars and supply blocks reduce wiring errors and installation labor cost. Connection modules for the CA7 Contactors simplify wiring and can reduce the number of DIN rails required, compacting panel space even further.

Advantages...

- Small foot print saves panel space, just 45 x 96 x 89 mm, up to 50% smaller than traditional MCCBs.
- Interrupt rating of 65kA at 480Y/277V may allow higher overall panel short circuit rating
- Up to 6 times higher interrupting rating vs. traditional miniature circuit breakers.

Ideal Applications...

- Feeder Circuits
 - Small Cabinets
 - Distribution panels
 - Branch circuit protection
 - Transformers
 - Heaters
- Control Circuits
 - Control Transformers
 - Power supplies
- Heating, air conditioning and refrigeration (HACR)
- High-intensity discharge
- Switching duty (SWD) 15 and 20 A



Compare these advanced features

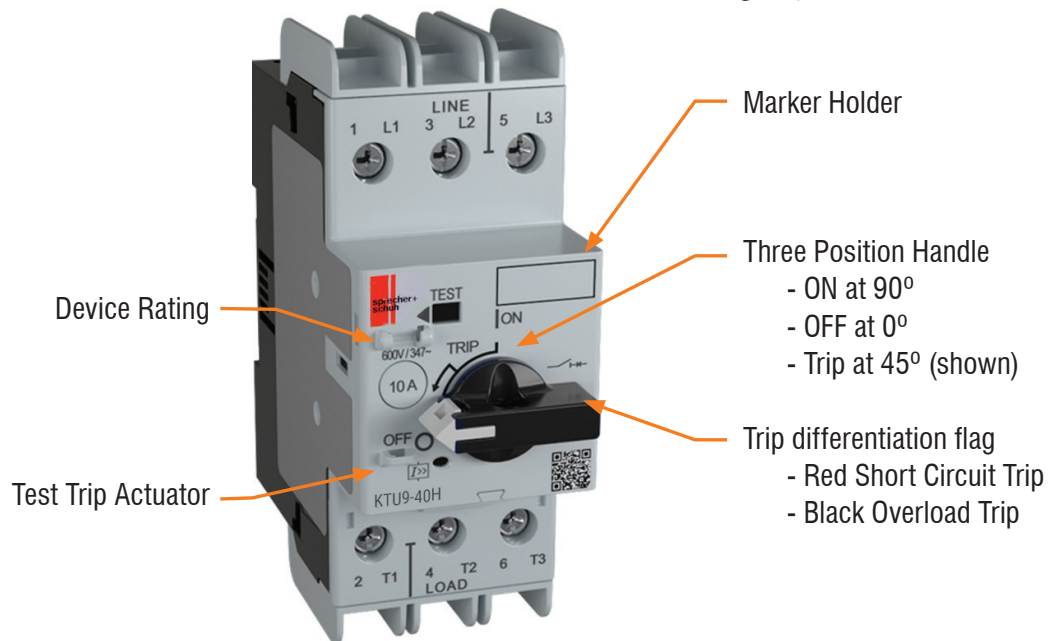

KTU9 Circuit Breaker, Fixed Thermal-Magnetic ②

Fixed Thermal Current Rating [A]	Magnetic Trip [A]	Interrupting Rating (60Hz) [KA]			Catalog Number
		240V	480Y/277V	600Y/347V	
KTU9-40H-2D — High Interrupting Capacity – 2-Pole					
0.5	15...20 x I _n	100	100	50	KTU9-40H-2D-0.5 ①
1.0	15...20 x I _n	100	100	50	KTU9-40H-2D-1 ①
2.0	15...20 x I _n	100	100	50	KTU9-40H-2D-2 ①
3.0	15...20 x I _n	100	100	50	KTU9-40H-2D-3 ①
4.0	15...20 x I _n	100	100	50	KTU9-40H-2D-4 ①
5.0	15...20 x I _n	100	100	50	KTU9-40H-2D-5 ①
6.0	15...20 x I _n	100	100	50	KTU9-40H-2D-6 ①
8.0	15...20 x I _n	100	100	50	KTU9-40H-2D-8 ①
10.0	15...20 x I _n	100	100	50	KTU9-40H-2D-10 ①
12.0	15...20 x I _n	65	65	25	KTU9-40H-2D-12
15.0	15...20 x I _n	65	65	25	KTU9-40H-2D-15
20.0	15...20 x I _n	65	65	~	KTU9-40H-2D-20
25.0	15...20 x I _n	65	65	~	KTU9-40H-2D-25
30.0	15...20 x I _n	65	65	~	KTU9-40H-2D-30
35.0	14 x I _n	65	65	~	KTU9-40H-2D-35
40.0	12 x I _n	65	65	~	KTU9-40H-2D-40
KTU9-40H-3D — High Interrupting Capacity – 3-Pole					
0.5	15...20 x I _n	100	100	50	KTU9-40H-3D-0.5 ①
1.0	15...20 x I _n	100	100	50	KTU9-40H-3D-1 ①
2.0	15...20 x I _n	100	100	50	KTU9-40H-3D-2 ①
3.0	15...20 x I _n	100	100	50	KTU9-40H-3D-3 ①
4.0	15...20 x I _n	100	100	50	KTU9-40H-3D-4 ①
5.0	15...20 x I _n	100	100	50	KTU9-40H-3D-5 ①
6.0	15...20 x I _n	100	100	50	KTU9-40H-3D-6 ①
8.0	15...20 x I _n	100	100	50	KTU9-40H-3D-8 ①
10.0	15...20 x I _n	100	100	50	KTU9-40H-3D-10 ①
12.0	15...20 x I _n	65	65	25	KTU9-40H-3D-12
15.0	15...20 x I _n	65	65	25	KTU9-40H-3D-15
20.0	15...20 x I _n	65	65	~	KTU9-40H-3D-20
25.0	15...20 x I _n	65	65	~	KTU9-40H-3D-25
30.0	15...20 x I _n	65	65	~	KTU9-40H-3D-30
35.0	14 x I _n	65	65	~	KTU9-40H-3D-35
40.0	12 x I _n	65	65	~	KTU9-40H-3D-40

Description

The KTU9 is a fixed trip, thermal-magnetic UL489 Molded Case Circuit Breaker.



KTU9-40H-3D







KTU9-40H-2D

F

KTU9 Molded Case Circuit Breakers

- ① Suitable for continuous operation at 100% of rating only if used in minimum enclosure space of 250 x 175 x 150 mm (10 x 7 x 6 in).
- ② KTU9 has independent thermal elements suitable for power distribution applications (not two slide bar differential tripping).

Accessories available for KTU9

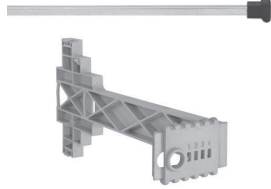
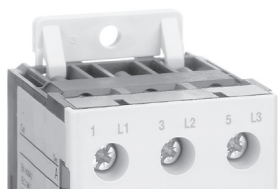
	<p>KT9-P.. Front/Side Mount Auxiliaries and Trip Contacts</p> <p>1-pole or 2-pole Side-mount not suitable for UL489 applications</p> <p>See pages F1.12-1.13</p>		<p>KT9-KN, KT9-KRY or KT9-DS</p> <p>See page F1.16</p>
	<p>KT9-UA Undervoltage Trips ② (UL 489 application up to 30 A) See page F1.14</p>		<p>Handle Assemblies KT9-SY or KT9-SB KT9-HTN or KT9-HTRY ②</p> <p>See page F1.15</p>
	<p>KT9-HT/HTL, KT9-S_/N_ & KT9-SHS Extension Shafts & Support</p> <p>See page F1.15</p>		<p>KT9-N45 Screw Adaptor</p> <p>See page F1.16</p>

F KTU9 Molded Case Circuit Breakers

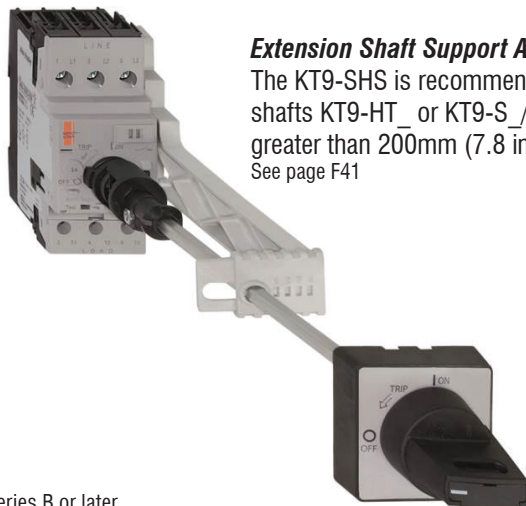

Extension Shaft Support Assembly

The KT9-SHS is recommended for handle shafts KT9-HT_ or KT9-S_/N_ in lengths greater than 200mm (7.8 inches).
See page F41

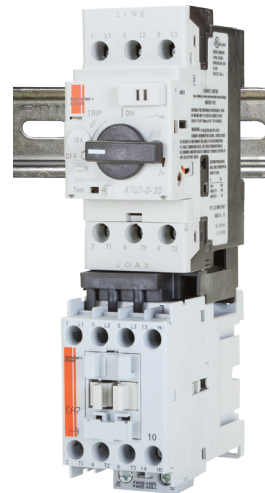

Remote Operation Application

The KTU9 3-Pole unit can be combined with CA7 using Connector Modules to achieve remote operation.

- For CA7-9...23 use KTU9-40H-PEC23

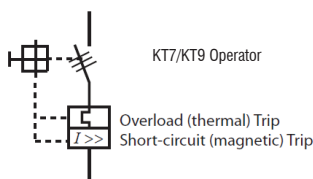

- ① Series B or later.
- ② Series E or later.
- ③ Undervoltage Trip Connection Diagram



Connecting Modules (for connecting KTU9 to CA7 AC coil, or CA7 Electronic DC coil contactors)

Module	Description	For Connecting...	To Contactor...	Catalog Number
	Connecting Modules <ul style="list-style-type: none"> • 25 Amp maximum • Provides electrical and mechanical interconnection of KTU9 3-Pole and CA7 (with AC coils) or CA7_E (with 12V or 24V Electronic DC coils) • KTU9 and Contactor mount on one DIN rail (see previous page for visual) 	KTU9-40H	CA7-9..23	KTU9-D-PEC23

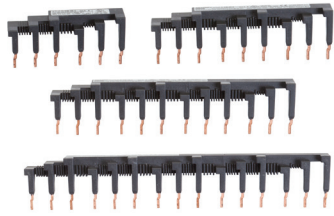
Compact Busbar System for KTU9

Accessory	Description	For Use With	Catalog Number
	Compact Busbar — 45 mm Spacing (Rated 64 A) <ul style="list-style-type: none"> • For use with front-mounted auxiliary contact Connects 2-KTU9s Connects 3-KTU9s Connects 4-KTU9s Connects 5-KTU9s (shown) 	KTU9-40H-3D	KTU9-D-DB-45-2 KTU9-D-DB-45-3 KTU9-D-DB-45-4 KTU9-D-DB-45-5
	Supply Block and Terminal <ul style="list-style-type: none"> • For power connection to Compact Busbar — 600V, KTU9-D...64A maximum • Top feed — overlaps commoning link • Meets requirements for terminal spacing from source • Compliant with UL489 Terminal Clearance standards 	KTU9-40H-3D	KTU9-D-A3E





IEC Performance Data

(CSA C22.2, UL 489, IEC / EN 60947-1, -2 in connection with a short-circuit protection device)

		KTU9-40H- 2 pole & 3 pole															
		0.5A	1A	2A	3A	4A	5A	6A	8A	10A	12A	15A	20A	25A	30A	35A	40A
Rated Operational Current I_n	[A]	0.5	1	2	3	4	5	6	8	10	12	15	20	25	30	35	40
Fixed Thermal Trip $I_t = I_n$	[A]	0.5	1	2	3	4	5	6	8	10	12	15	20	25	30	35	40
Fixed Magnetic Trip $I_m =$	[A]	15...20 x I_n															
Ultimate Short Circuit Breaking Capacity (50 Hz) I_{cu}																	
230/240V	[kA]	100	100	100	100	100	100	100	100	100	100	100	100	100	100	100	100
400/415V	[kA]	100	100	100	100	100	100	100	100	100	65	65	65	65	65	65	65
500/525V	[kA]	65	65	65	65	65	65	65	65	65	65	65	65	65	65	65	65
690V	[kA]	50	50	18	18	18	18	18	10	10	10	10	10	10	10	10	10
Rated Service Short Circuit Breaking Capacity (50 Hz) I_{cs}																	
230/240V	[kA]	100	100	100	100	100	100	100	100	100	100	100	100	100	100	100	100
400/415V	[kA]	65	65	65	65	65	65	65	65	65	50	50	50	50	50	50	50
500/525V	[kA]	65	65	65	65	65	65	65	65	65	50	50	50	25	25	25	25
690V	[kA]	50	50	10	10	10	10	10	6	6	6	6	6	6	6	6	6

General Data

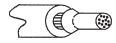
		KTU9-D	
Number of Poles			2 and 3
Rated Insulation	IEC, / EN	[V]	690
Voltage U_i	UL, CSA	[V]	690
HACR Ratings	Suitable for continuous operation at 100% of rating only if used in enclosure space for	480Y/277V 600Y/347V	0.5...15 A, cubicle space 250 x 175 x 150 mm (10 x 7 x 6 in) 0.5...15 A, cubicle space 300 x 175 x 150mm (11.8 x 7 x 6in)
Rated Impulse Withstand Voltage U_{imp}	Pollution degree		3
	Main circuits U_{imp} /Overvoltage Category		6 kV/III
	Auxiliary circuits U_{imp} /Overvoltage Category		6 kV/III
	Safe separation between main and auxiliary circuits		up to 400V
Rated Frequency		[Hz]	50/60
Utilization Category	IEC 60947-2 (Circuit breaker)		A
Life Span	Mechanical	[operations]	100,000
	Electrical (I_e max.)	[operations]	10,000
	Switching Frequency	[operations/hour]	max. 25
Ambient Temperature	Storage	[°C (°F)]	-40...+80
	Operation	[°C (°F)]	-25...+60 (70 with 15% In current reduction) (-13...+140 °F [+158 with 15% In current reduction])
Climate Resistance	Moisture / Heat Resistance	(600068-2-30)	23 °C (73 °F)/83% relative humidity and 40 °C (104 °F)/92% relative humidity, 56 cycles
	Dry Heat	(60086-2-2)	100 °C (212 °F), relative humidity < 50%, 7 days
	Moisture Heat	(60068-2-3)	40 °C (104 °F), relative humidity 93%, 56 days
Site Altitude		[m]	up to 2000 N.N. (6561 ft)
Protection Class			IP2X when wired
Resistance to Shock, Transport		(60068-2-27)	30G, 11 ms, all axes
Resistance to Vibration, Operation		(60068-2-6)	18 G
Overload Protection Characteristics			Yes per IEC/EN 60947-2, UL489, CSA 22.2
Ambient Temperature Compensation		[°C (°F)]	-25...+60 (-13...+140)
Phase-loss Protection			No
Short-circuit protection (Magnetic)			fixed setting 15...20 x In, (35 A - 14 x In and 40 A - 12 x In)
Backfeeding			Suitable for backfeeding up to 480Y/277V
Total Power loss P_v	at In max	[W]	7.5
Main Disconnect Switch Application			Yes, with accessories
HID (High Intensity Discharge) Listed			0.5...40 A
Switching Duty			15 A, 20 A
Heating, air conditioning and refrigeration (HACR)			0.5...40 A
Application Conditions	For utilization outside North America, assemblies (of products) shall comply to the IEC 61439-1 requirements KTU9 are intended for use in closed areas without hazardous operating conditions such as dust or explosive or corrosive gases. Enclosures of appropriate manner need to be in place to protect devices in such environments.		
Standards Compliance			UL489; CSA C22.2 No. 5(1); IEC / EN 60947-1, -2
Certifications			CE; cULus Listed Circuit Breaker (pending)

Connection		No. of conductors	KTU9 ≤ 15A	KTU9 > 15A
Power Terminals				
	Terminal Type		Screw Clamp up to 16 A, M4 Pozidriv No.2/Blade No.3	Screw Clamp greater than 16 A, M4 Pozidriv No.2/Blade No.3
	Screwdriver			
Solid or stranded 	1 conductor		1...6 mm ²	1.5...10 mm ²
	2 conductor		1...2.5 mm ² 2.5...6 mm ²	1.5...4 mm ² 4...10 mm ²
Flexible with ferrule (end sleeve) 	1 conductor		1...6 mm ²	1.5...10 mm ²
	2 conductor		1...2.5 mm ² 2.5...4 mm ²	1.5...4 mm ² 4...10 mm ²
Finely stranded 	1 conductor		1.5...6 mm ²	2.5...10 mm ²
	2 conductor		1.5...4 mm ² 2.5...6 mm ²	2.5...6 mm ² 4...10 mm ²
Cross section per UL/CSA solid, stranded 	1 conductor		No. 14...10 AWG	No. 14...8 AWG
	2 conductor		No. 14...10 AWG	No. 14...10 AWG No. 12...8 AWG
Stripping length			10 mm (0.39 in.)	10 mm (0.39 in.)
Tightening torque		[Nm]/[lb-in.]	2...2.5 / 18...22	2...2.5/18...22

F KTU9 Molded Case Circuit Breakers

Time-Current Characteristic

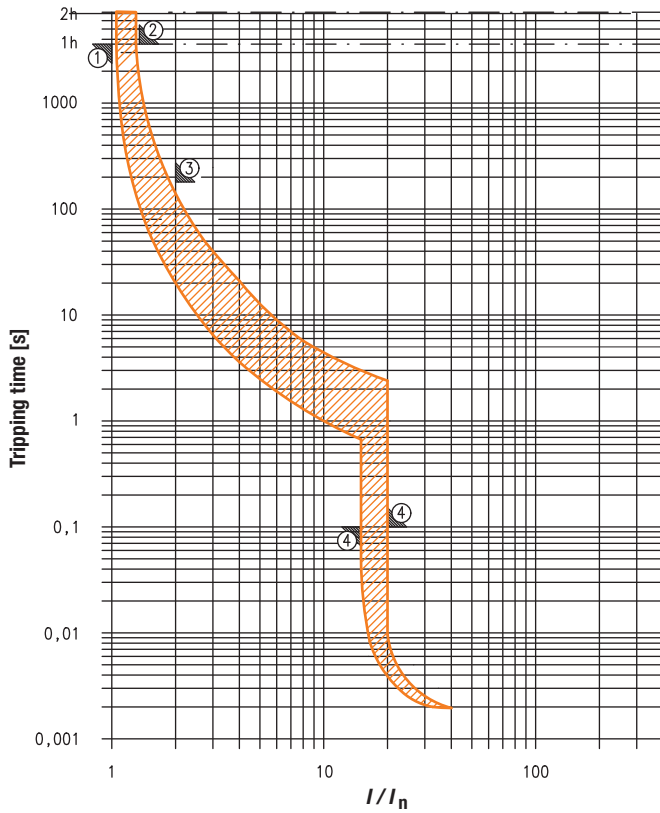

**Tripping characteristic
acc. to UL 489 and IEC 60947-2**

- ① conventional non-tripping current $I_{nt} = 1.0 I_n$
- ② conventional tripping current $I_t = 1.35 I_n ; t < 1h$
- ③ $2.0 I_n ; t = 180s$ max.

**Instantaneous tripping
acc. to UL 489 and IEC 60947-2**

- ④ Trip Curve : $15 \dots 20 I_n$

F

KTU9 Molded Case Circuit Breakers

Cut-off Current ①

KTU9-40H-D*-*
Max. Cut-Off Current at $U_0=480V/60Hz$

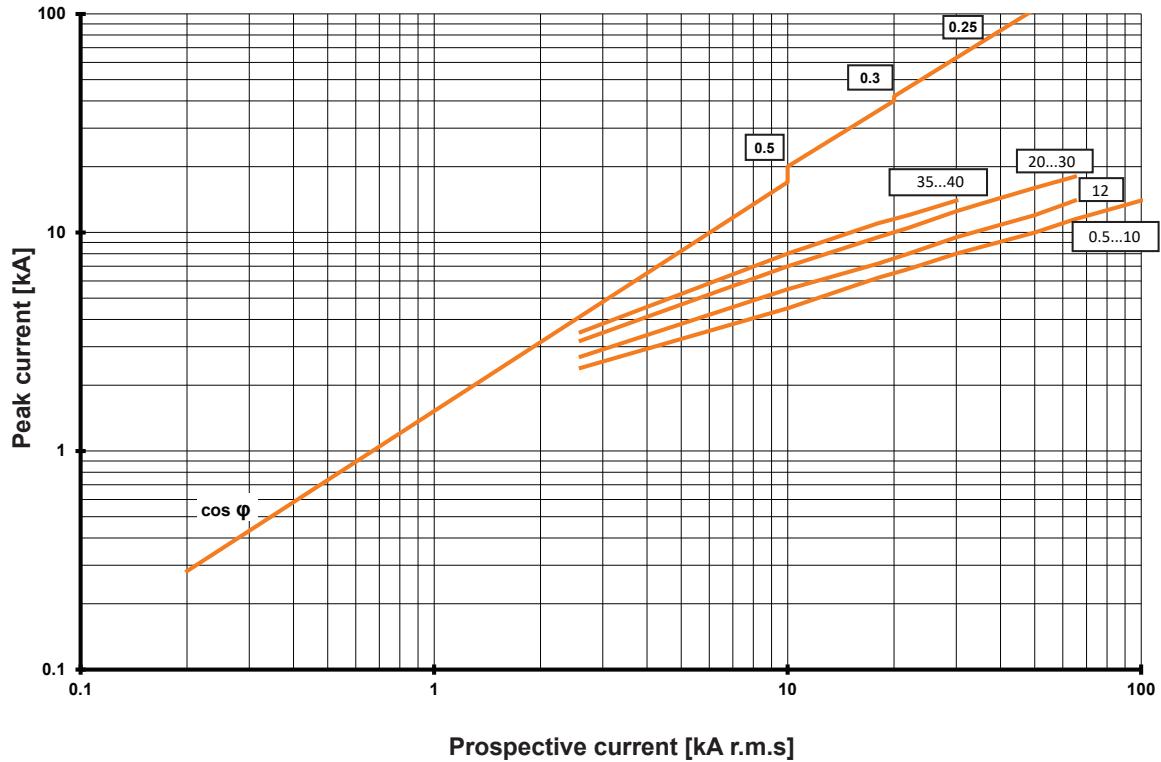

KTU9-40H-D*-*
Max. Let-Through-Energy at $U_0=480V/60Hz$

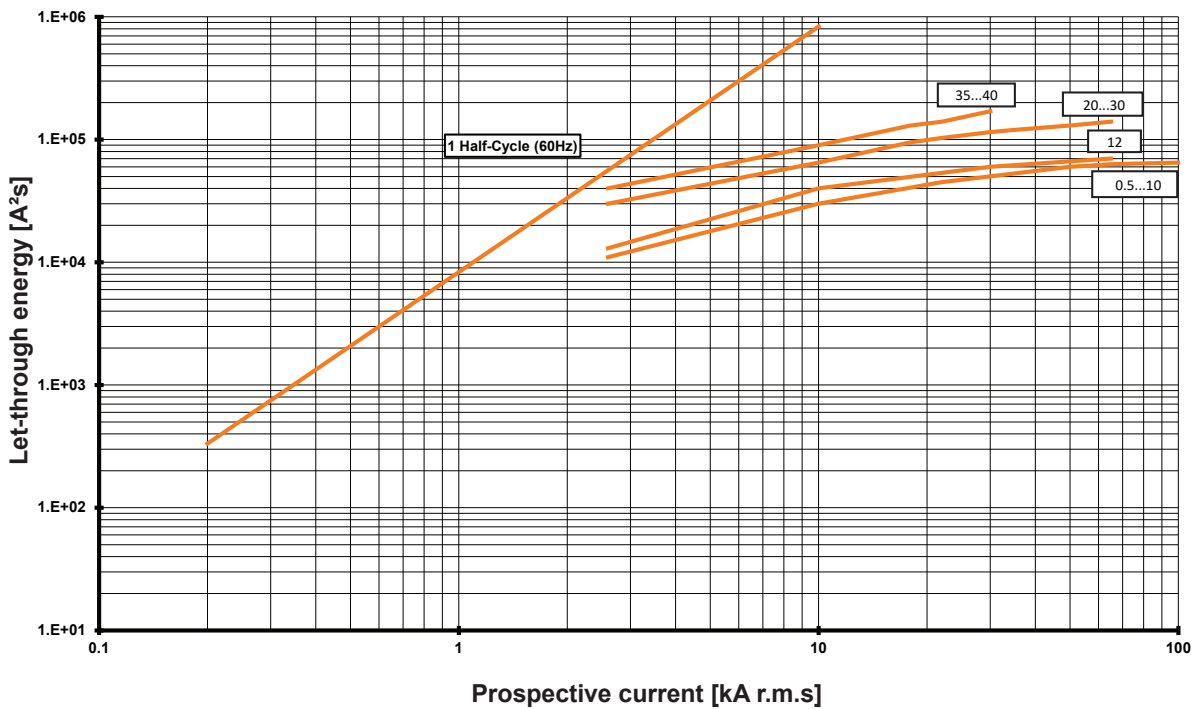

① A full size (8-1/2 x 11) set of "Maximum Cut-Off Current (Let-Thru Current)" and "Maximum Let-thru Energy (I²t)" curves for 400...415V, 500V and 690V can be downloaded from <http://www.sprecherschuh.com>.

F
KTU9 Molded Case Circuit Breakers

Cut-off Current ①

KTU9-40H-D*-*
Max. Cut-Off Current at $U_e=600V/60Hz$

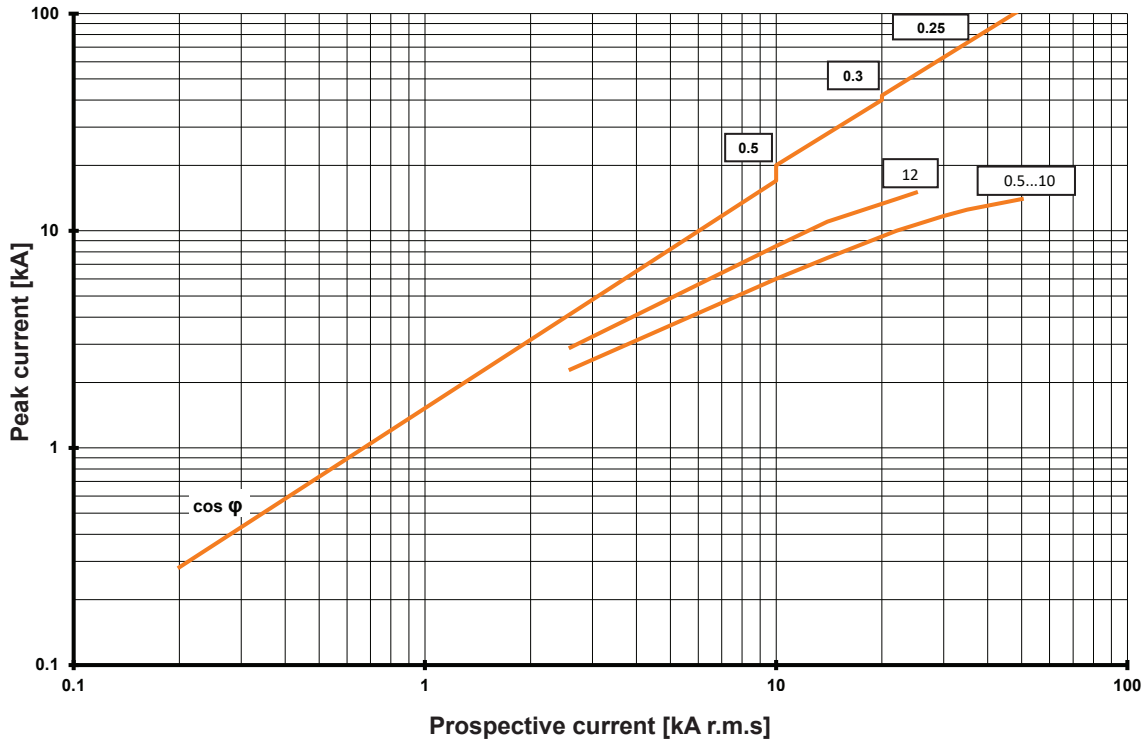

KTU9-40H-D*-*
Max. Let-Through-Energy at $U_e=600V/60Hz$

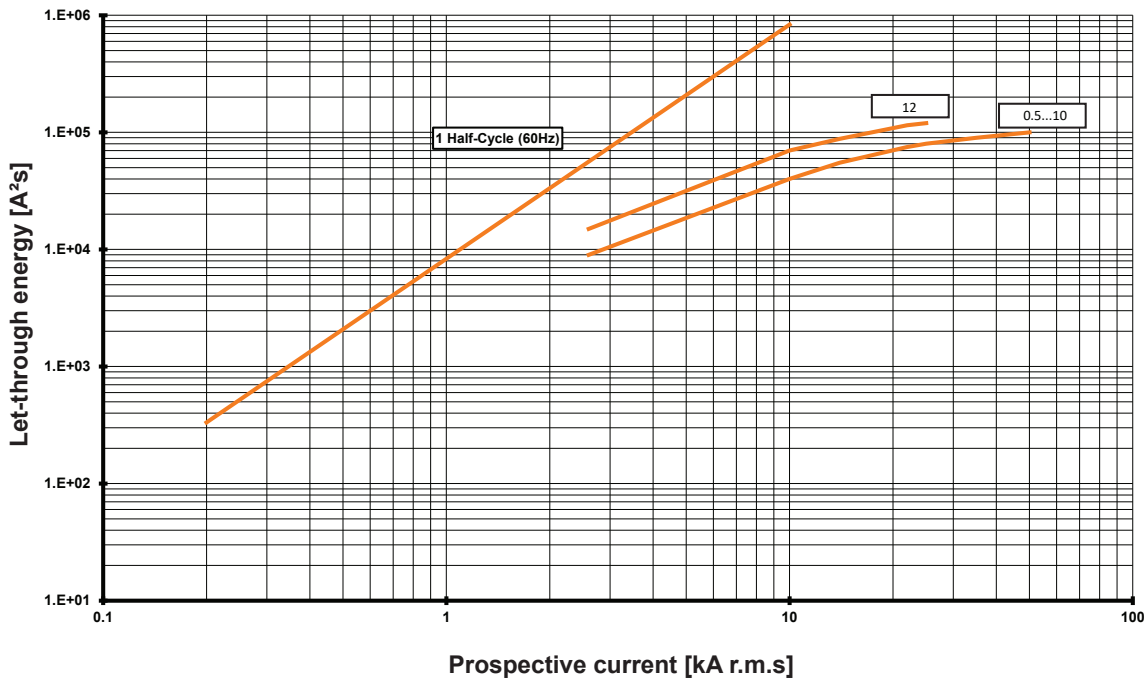

① A full size (8-1/2 x 11) set of "Maximum Cut-Off Current (Let-Thru Current)" and "Maximum Let-thru Energy (I²t)" curves for 400...415V, 500V and 690V can be downloaded from <http://www.sprecherschuh.com>.

KTU9-40H Dimensions

Dimensions are in millimeters (inches). Dimensions not intended for manufacturing purposes.

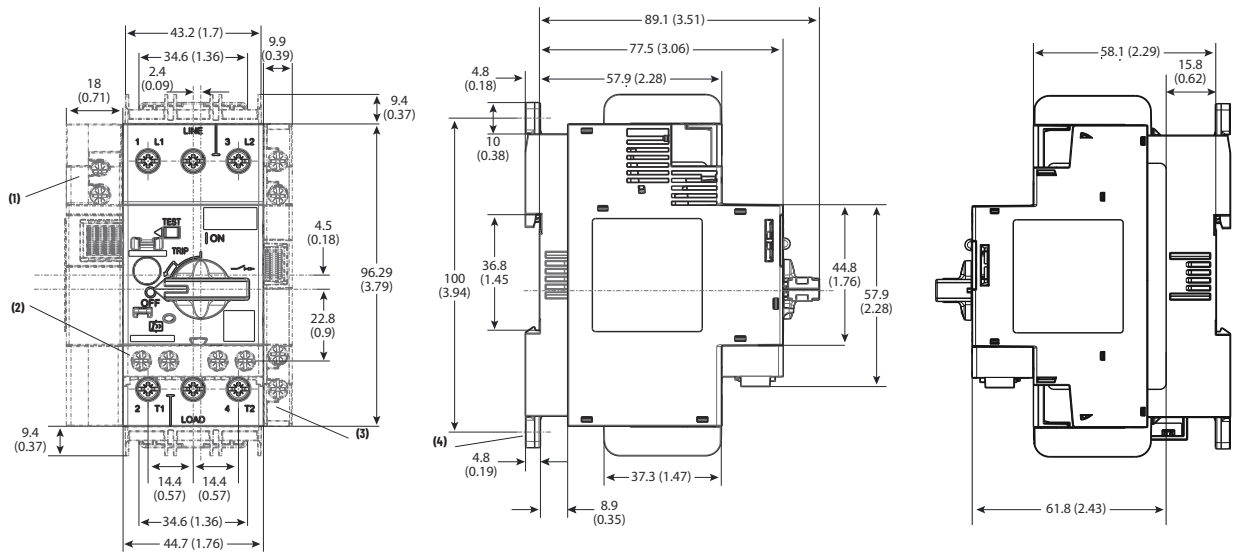

Note	Information
1	Undervoltage/shunt trip
2	Auxiliary contact (front mounted)
3	Auxiliary contact (side mounted)
4	Screw mounting adapter

KTU9 Wiring Diagram

**3-Phase
KTU9-40H-3D**

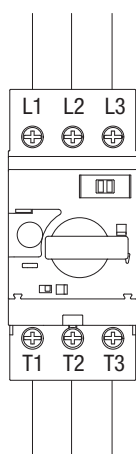

**2-Phase
KTU9-40H-2D**

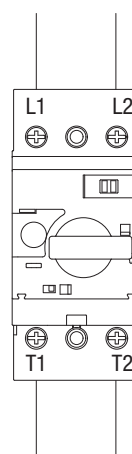

F
KTU9 Molded Case Circuit Breakers

KTU9 with Screw Adaptor KT9-N45

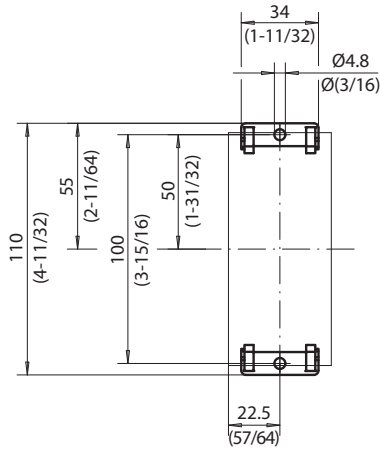

KTU9 Mounting Position

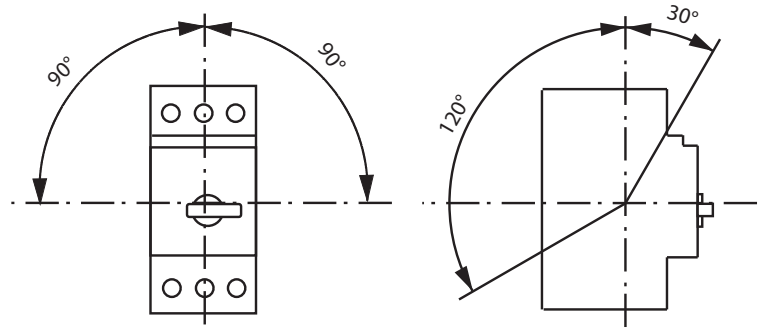

KTU9 Circuit Breaker Enclosure Requirements

Mounting Position and Spacing Requirements

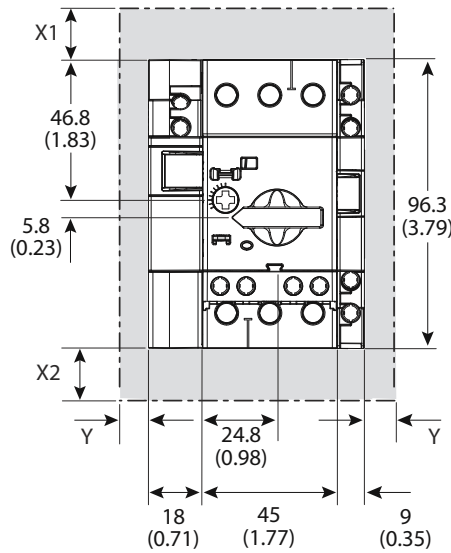

Voltage [V AC]	Minimum Distance to Grounded Parts or Walls [mm (in.)]		
	X1	X2	Y
400	30 (1-3/16)	30 (1-3/16)	9 (23/64)
500	30 (1-3/16)	30 (1-3/16)	9 (23/64)
690	50 (1-31/32)	50 (1-31/32)	30 (1-3/16)

F

KTU9 Molded Case Circuit Breakers

