

# KWIKstarters

Preassembled or build from stock – Easy, fast, economical enclosed starters for applications up to 30HP

KWIKstarters

Sprecher + Schuh offers a broad selection of pre-assembled or “build-from-stock” starters housed in a high impact, non-metallic, cUL Approved, Type 1, 12, 4, 4X enclosure. Built for convenience, space savings and economy, KWIKstarters are efficiently designed to use stock CA7 contactors and CEP7 overloads usually stocked by distributors. Contactor and overload are either pre-wired and pre-mounted onto the enclosure’s built-in DIN-rail or may be ordered as separate components. Ample knockouts and open terminals guarantee quick, no fuss wiring.



KWIKstarters are available with our advanced CEP7 Solid State Overload Relay

## Sized for most industrial applications

KWIKstarters control motors up to 30HP @ 460V in two sizes of enclosures, measuring only 208 x 98mm (7.4” x 3.9”) or 250 x 125mm (9.85” x 4.93”) for our larger sizes. This covers over 85% of industrial motor control applications in a very compact package that can be mounted adjacent to or directly on equipment.



KWIKstarters are equipped with Overload protection as standard

## Solid state overload options

KWIKstarters, sizes 9 to 23 amps, are supplied with Sprecher+Schuh’s CEP7 solid state overload relay. The CEP7 overload is also standard on larger sizes (sizes 30 to 43 amps). The CEP7 solid state overload relays measure motor current directly through integrated current transformers and on board electronics. The electronics provide increased accuracy and numerous other advantages over electromechanical relays. Learn more about Sprecher + Schuh overload relays in Section B of this catalog.

## Build it yourself...

KWIKstarters may be assembled from stock components. Just grab a CA7 contactor and overload of your choice and snap them into the enclosure. Minimal wiring is required and assembly can be completed in minutes.



Start-Stop or Reset only

Hand-Off-Auto with Pilot Light

Emergency Stop

Multi-Function

Forward-Stop-Reverse options

Combination Kwikstarters

# CX7 KWIKstarters

## Type E/F Combination Motor Controllers

KTA9 can be applied in combination with a CA7 contactor for remote control and an enclosure with matching environmentally approved thru-the-door handle disconnect mechanism to meet all requirements for a Construction Type E or F Combination Starter. This selection of individual Combination starters are smaller and are less expensive than Classic Construction Type A (Fusible), or Type C (Thermal-magnetic Molded Case Circuit Breaker), as offered in the following pages.

Sprecher + Schuh has developed a KWIKStarter version of the Combination Motor Controller which can be easily field assembled or can be purchased as a factory assembly. For details and catalog number selection on these economical combination starter alternatives turn to page F98.

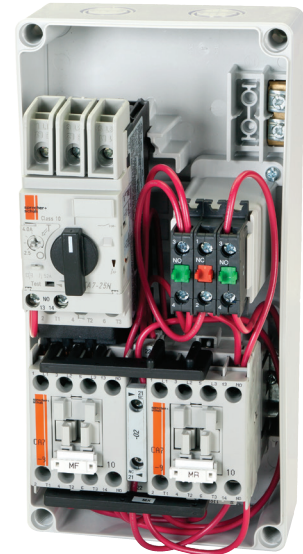

**C**  
KWIKstarters





## Why Type E/F?

NEC430-53.C.1 defines that the short-circuit protection of a single motor branch circuit shall be provided by a set of fuses or a thermal-magnetic molded case circuit breaker. Alternatively NEC 430-53.C.6 also permits the use of a Self-protected Combination Motor Controller can be used to not only provide short-circuit protection for a single motor branch circuit but also provide a means of disconnect and overload protection. Self-protected Combination motor controllers like KTA9 can be combined with CA7, providing a coil for cover control or remote operation. This results in a Construction Type E or Type F (based on selection depending on published UL ratings) Combination starter per UL508. For details of UL, NEC and CSA application standards and rules please see our online white paper, Applying KT9 Motor Controllers.

See page F98 for  
**Type E/F**  
**CX7**  
KWIKstarters

#### KWIKstarters with CEP7 Overload Relays ①

Cover Control/ Enclosure (KS7-COS1/COS4)	Maximum Horsepower						Total Aux. Contacts Installed		cUL Approved- Type 1/12/4/4X IP66	Dimension Code
	Single Ø		Three Ø							
	115V	230V	200V	230V	460V	575V	NO	NC		
<b>KWIKstarter with Start &amp; Raised Stop ④⑤</b>										
	1/2	1 1/2	~	~	~	~	1 ②	0	CBK7-9-*-◆-P2 CAK7-9-*-◆-P2	Q1
	~	~	2	2	5	7 1/2				
	1/2	2	~	~	~	~	1 ②	0	CBK7-12-*-◆-P2 CAK7-12-*-◆-P2	Q1
	~	~	3	3	7 1/2	10				
	1	3	~	~	~	~	1 ②	0	CBK7-16-*-◆-P2 CAK7-16-*-◆-P2	Q1
	~	~	5	5	10	15				
	2	3	~	~	~	~	1 ②	0	CBK7-23-*-◆-P2 CAK7-23-*-◆-P2	Q1
	~	~	5	7 1/2	15	15				
<b>KWIKstarter with Reset</b>										
	1/2	1 1/2	~	~	~	~	1	0	CBK7-9-*-◆-P0 CAK7-9-*-◆-P0	Q1
	~	~	2	2	5	7 1/2				
	1/2	2	~	~	~	~	1	0	CBK7-12-*-◆-P0 CAK7-12-*-◆-P0	Q1
	~	~	3	3	7 1/2	10				
	1	3	~	~	~	~	1	0	CBK7-16-*-◆-P0 CAK7-16-*-◆-P0	Q1
	~	~	5	5	10	15				
	2	3	~	~	~	~	1	0	CBK7-23-*-◆-P0 CAK7-23-*-◆-P0	Q1
	~	~	5	7 1/2	15	15				

#### Coil Codes ⑤

A.C. Coil Code	Voltage Range		Control Source	
	50 Hz	60 Hz	CBK7	CAK7
24Z	24V	24V	Separate	Separate
120	110V	120V	Common	Separate
220W	200V-220V	208V-240V	Common	Common
277	240V	277V	Common	~
415	400-415V	~	~	Common
480	440V	480V	~	Common
600	550V	600V	~	Common

#### Control Circuit Note

**Common:** Coils are assumed to be common with the line voltage and will be connected to the line source (L1-L2) per the table.



**Separate:** Coils are assumed to be from a separate source and will not be connected to the line source per the table.

#### Ordering Instructions

Specify Catalog Number	
Replace (*) with Coil Code Replace (◆) with O/L Relay	<b>See this page See page C30</b>
<b>Important Note:</b> KWIKstarters (Q1 dim.) are only designed to accommodate CEP7 Solid State Overload Relays. Select O/L Relay Code from page C30.	

- ① KWIKstarters are designed for three-wire control circuits. Two-wire (maintain) control can be accomplished by adding pushbutton latch KS7-PLA.
- ② A special design NO auxiliary contact (Cat.# KS7-PCK) is used as the holding circuit interlock, as well as, the START button interface. It is not available for other use.
- ③ Refer to page C33 for dimensional information.
- ④ STOP button also functions as RESET button. Plastic Bezel is standard.
- ⑤ Other voltages available, see Section A.

**KWIKstarters with CEP7 Overload Relays ①④⑤**

Cover Control/ Enclosure (KS7-COS1/COS4)	Maximum Horsepower						Total Aux. Contacts Installed		cUL Approved- Type 1/12/4/4X IP66	Dimension Code
	Single Ø		Three Ø							
	115V	230V	200V	230V	460V	575V	NO	NC	Catalog Number	⑤
<b>KWIKstarter with Start &amp; Raised Stop ④⑤</b>										
	1/2	1 1/2	~	~	~	~	1 ②	0	CBK7-9E-*-◆-P2	Q1
	~	~	2	2	5	7 1/2			CAK7-9E-*-◆-P2	
	1/2	2	~	~	~	~	1 ②	0	CBK7-12E-*-◆-P2	Q1
	~	~	3	3	7 1/2	10			CAK7-12E-*-◆-P2	
	1	3	~	~	~	~	1 ②	0	CBK7-16E-*-◆-P2	Q1
	~	~	5	5	10	15			CAK7-16E-*-◆-P2	
	2	3	~	~	~	~	1 ②	0	CBK7-23E-*-◆-P2	Q1
	~	~	5	7 1/2	15	15			CAK7-23E-*-◆-P2	
<b>KWIKstarter with Reset</b>										
	1/2	1 1/2	~	~	~	~	1	0	CBK7-9E-*-◆-P0	Q1
	~	~	2	2	5	7 1/2			CAK7-9E-*-◆-P0	
	1/2	2	~	~	~	~	1	0	CBK7-12E-*-◆-P0	Q1
	~	~	3	3	7 1/2	10			CAK7-12E-*-◆-P0	
	1	3	~	~	~	~	1	0	CBK7-16E-*-◆-P0	Q1
	~	~	5	5	10	15			CAK7-16E-*-◆-P0	
	2	3	~	~	~	~	1	0	CBK7-23E-*-◆-P0	Q1
	~	~	5	7 1/2	15	15			CAK7-23E-*-◆-P0	

**C**  
KWIKstarters

**Coil Codes ⑤**

DC Coil Codes	Voltage
12E	12V
24E	24V

**Ordering Instructions**

Specify Catalog Number	
Replace (*) with Coil Code	<b>See this page See page C30</b>
Replace (◆) with O/L Relay	
<b>Important Note:</b> KWIKstarters (Q1 dim.) are only designed to accommodate CEP7 Solid State Overload Relays. Select O/L Relay Code from page C30.	

- ① KWIKstarters are designed for three-wire control circuits. Two-wire (maintain) control can be accomplished by adding pushbutton latch KS7-PLA.
- ② A special design NO auxiliary contact (Cat.# KS7-PCK) is used as the holding circuit interlock, as well as, the START button interface. It is not available for other use.
- ③ Refer to page C33 for dimensional information.
- ④ STOP button also functions as RESET button. Plastic Bezel is standard.
- ⑤ CA7-9E...23E with electronic coils are not interchangeable with non-electronic DC or AC coils

#### KWIKstarters with CEP7 Overload Relays ①

Enclosure (KS7-C2S4)	Maximum Horsepower						Total Aux. Contacts Installed		cUL Approved-Type 1/12/4/4X IP66	Dimension Code
	Single Ø		Three Ø							
	115V	230V	200V	230V	460V	575V	NO	NC	Catalog Number	③
	<b>KWIKstarters with AC Coil</b>									
	2	5	~	~	~	~	1	0	CBK7-30-*♦-P▼	Q2
	~	~	7-1/2	10	20	25			CAK7-30-*♦-P▼	
	3	5	~	~	~	~	1	0	CBK7-37-*♦-P▼	Q2
	~	~	10	10	25	30			CAK7-37-*♦-P▼	
	3	7-1/2	~	~	~	~	1	0	CBK7-43-*♦-P▼	Q2
	~	~	10	15	30	30			CAK7-43-*♦-P▼	

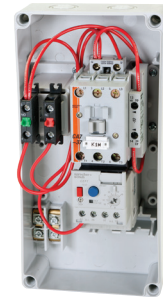

**Control Circuit Note**  
**Common:** Coils and pilot devices in the control circuit are assumed to be common with the line voltage and will be connected to the line source (L1-L2) per the table.  
**Separate:** Coils and pilot devices in the control circuit are assumed to be from a separate source and will not be connected to the line source per the table. Pilot lights are 240 VAC maximum.

#### Replace ♦ with one of the following Overload Relays

For use with KWIKstarter...	Amp Range	Overload Relay Code (♦)	Catalog No. (of Overload Relay used)
<b>1-Phase &amp; 3-Phase / Manual Reset / Class 10 or 20</b>			
CAK7-30...43	5.4...27	1EED	CEP7-1EED
	11...55	1EFD	CEP7-1EFD
<b>1-Phase &amp; 3-Phase / Auto or Manual Reset / Class 10...30 *</b>			
CAK7-30...43	5.4...27	FED	CEP7-1EFED
	11...55	FFD	CEP7-1EFFD

\* List Price Adder applies

#### Pilot Device Options (includes reset) ②⑤

Pushbutton Description	Replace ▼ in catalog number with
START-STOP Multi-function (shown)	3U
I-O Multi-function	4U
OFF-ON 2-Position Selector switch	6
Pilot Light Red (LED) with START-STOP Multi-function *	1R3U
Pilot Light Red (LED) with I-O Multi-function *	1R4U

#### Optional CA7 Modifications (Factory Assembled) \*

Description	Add to end of catalog number
Electronic Interface	-JE
Surge Suppressor RD	-C
Surge Suppressor Varistor	-V
Additional NC Contact	-L01
Additional NO Contact	-L10

\* List Price Adder applies

#### Coil Codes (\*) ④⑥

A.C. Coil Code	Voltage Range		Control Source	
	50 Hz	60 Hz	CBK7	CAK7
24Z	24V	24V	Separate	Separate
120	110V	120V	Common	Separate
220W	200-220V	208-240V	Common	Common
277	240V	277V	Common	~
415	400-415V	~	~	Common
480	440V	480V	~	Common
600	550V	600V	~	Common

#### Ordering Instructions

Specify Catalog Number	<b>See this page only</b>
Replace (*) with Coil Code	
Replace ♦ with O/L Relay	
Replace ▼ with Pilot Device Option	

- ① Use CEP7-1\_\_ overloads only – and also backward compatible to CEP7-ED1/EE.
- ② Plastic Bezel is standard. Pilot Device options include D7-BX\_ Base Mounted contact blocks. See page H69 for more information.
- ③ Refer to page C31 for wiring diagram and C34 for dimensional information.
- ④ Other voltages available, see Section A.
- ⑤ One and only one Pilot Device option must be selected. If Pilot Light option is selected then coil voltage must be 24V, 120V or 240V AC only.
- ⑥ CPT not possible with KS7-C2S4 (Q2) enclosure.

**KWIKstarters with CEP7 Overload Relays ❶**

Enclosure (KS7-C2S4)	Maximum Horsepower						Total Aux. Contacts Installed		cUL Approved-Type 1/12/4/4X IP66	Dimension Code
	Single Ø		Three Ø				NO	NC		
	115V	230V	200V	230V	460V	575V			Catalog Number	
	<b>KWIKstarters with Electronic DC Coil ❹</b>									
	2	5	~	~	~	~	1	0	CBK7-30E-❖-❖-P▼	Q2
	~	~	7-1/2	10	20	25			CAK7-30E-❖-❖-P▼	
	3	5	~	~	~	~	1	0	CBK7-37E-❖-❖-P▼	Q2
	~	~	10	10	25	30			CAK7-37E-❖-❖-P▼	
	3	7-1/2	~	~	~	~	1	0	CBK7-43E-❖-❖-P▼	Q2
	~	~	10	15	30	30			CAK7-43E-❖-❖-P▼	

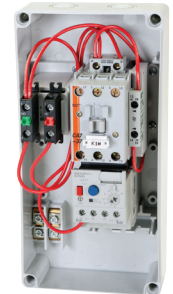

**C**  
KWIKstarters

**Replace ❖ with one of the following Overload Relays**

For use with KWIKstarter...	Amp Range	Overload Relay Code (❖)	Catalog No. (of Overload Relay used)
<b>1-Phase &amp; 3-Phase / Manual Reset / Class 10 or 20</b>			
CAK7-30...43	5.4...27	1EED	CEP7-1EEED
	11...55	1EFD	CEP7-1EEFD
<b>1-Phase &amp; 3-Phase / Auto or Manual Reset / Class 10...30 *</b>			
CAK7-30...43	5.4...27	FED	CEP7-1EFED
	11...55	FFD	CEP7-1EFFD

\* List Price Adder applies

**Pilot Device Options (includes reset) ❷❸**

Pushbutton Description	Replace ▼ in catalog number with
START-STOP Multi-function (shown)	3U
I-O Multi-function	4U
OFF-ON 2-Position Selector switch	6
Pilot Light Red (LED) with START-STOP Multi-function *	1R3U
Pilot Light Red (LED) with I-O Multi-function *	1R4U

**Optional CA7 Modifications (Factory Assembled)\***

Description	Add to end of catalog number
Electronic Interface	-JE
Surge Suppressor RD	-C
Surge Suppressor Varistor	-V
Additional NC Contact	-L01
Additional NO Contact	-L10

\* List Price Adder applies

**Coil Codes ❹❺**

D.C. Coil Code	Voltage Range VDC
12E	12V
24E	24V
36E	36-48V
48E	48-72V
110E	110-125V
220E	220-250V

**Ordering Instructions**

Specify Catalog Number	
Replace (❖) with Coil Code	See this page only
Replace (❖) with O/L Relay	
Replace (▼) with Pilot Device Option	

- ❶ Use CEP7-1\_\_ overloads only – and also backward compatible to CEP7-ED1/EE.
- ❷ Plastic Bezel is standard. Pilot Device options include D7-BX\_ Base Mounted contact blocks. See page H69 for more information.
- ❸ Refer to page C31 for wiring diagram and C34 for dimensional information.
- ❹ CA7-9E...55E with electronic coils are not interchangeable with non-electronic DC or AC coils.
- ❺ One and only one Pilot Device option must be selected.
- ❻ CPT not possible with KS7-C2S4 (Q2) enclosure.

### KWIKstarters with CEP7 Overload Relays with H-O-A and Light ①②③④

Cover Control/ Enclosure	Maximum Horsepower						Total Aux. Contacts Installed		cUL Approved- Type 1/12/4/4X IP66	Dim Code
	Single Ø		Three Ø				NO	NC		
	115V	230V	200V	230V	460V	575V			Catalog Number	
	<b>KWIKstarter with Reset and H-O-A Selector Switch and Light with AC Coil</b>									
	1/2	1 1/2	~	~	~	~	1	0	CBK7-9-♦-P0+1R7	Q1
	~	~	2	2	5	7 1/2			CAK7-9-♦-P0+1R7	
	1/2	2	~	~	~	~	1	0	CBK7-12-♦-P0+1R7	Q1
	~	~	3	3	7 1/2	10			CAK7-12-♦-P0+1R7	
	1	3	~	~	~	~	1	0	CBK7-16-♦-P0+1R7	Q1
	~	~	5	5	10	15			CAK7-16-♦-P0+1R7	
	2	3	~	~	~	~	1	0	CBK7-23-♦-P0+1R7	Q1
	~	~	5	7 1/2	15	15			CAK7-23-♦-P0+1R7	
	<b>KWIKstarter with Reset and H-O-A Selector Switch and Light with Electronic DC Coil ⑤</b>									
	1/2	1 1/2	~	~	~	~	1	0	CBK7-9E-♦-P0+1R7	Q1
	~	~	2	2	5	7 1/2			CAK7-9E-♦-P0+1R7	
	1/2	2	~	~	~	~	1	0	CBK7-12E-♦-P0+1R7	Q1
	~	~	3	3	7 1/2	10			CAK7-12E-♦-P0+1R7	
1	3	~	~	~	~	1	0	CBK7-16E-♦-P0+1R7	Q1	
~	~	5	5	10	15			CAK7-16E-♦-P0+1R7		
2	3	~	~	~	~	1	0	CBK7-23E-♦-P0+1R7	Q1	
~	~	5	7 1/2	15	15			CAK7-23E-♦-P0+1R7		

### Coil Codes ⑥

A.C. Coil Code	Voltage Range		Control Source	
	50 Hz	60 Hz	CBK7	CAK7
24Z	24V	24V	Separate	Separate
120	110V	120V	Common	Separate
220W	200-220V	208-240V	Common	Common
D.C. Coil Code	Voltage Range			
	VDC			
12E	12V			
24E	24V			

### Control Circuit Note

**Common:** Coils and pilot devices in the control circuit are assumed to be common with the line voltage and will be connected to the line source (L1-L2) per the table.

**Separate:** Coils and pilot devices in the control circuit are assumed to be from a separate source and will not be connected to the line source per the table. Line Voltage not listed: (i.e.: 480 and 575 VAC) require a separate control source (i.e.: 120 VAC). D7D pilot devices are rated 300 VAC maximum.

### Ordering Instructions

Specify Catalog Number	
Replace (*) with Coil Code	<b>See this page</b> <b>See page C30</b>
Replace (♦) with O/L Relay	
<b>Important Note:</b> KWIKstarters (Q1 dim.) are only designed to accommodate CEP7 Solid State Overload Relays. Select O/L Relay Code from page C30.	

- ① This is a factory assembly. The KS7-COS1 (Q1) enclosure does not include knock-outs for field assembly of this starter.
- ② Uses D7D-P4N\_ Red Monolithic "Run" pilot light with LED bulb. Pilot light voltage to match coil voltage for 24, 120, 240 VAC control. Red "Run" Light can be changed for Green. Change +1R7 to +1G7. For example, CAK7-9-♦-P0+1R7 becomes CAK7-9-♦-P0+1G7.
- ③ Uses D7D-SM32x20 Monolithic 3-position selector switch for maintain control, HAND-OFF-AUTO function with legend plate.
- ④ Refer to page C32 for wiring and dimensional information. This is a clam-shell enclosure design with wires to cover controls.
- ⑤ One NO auxilliary for customer use. There is no room for additional auxilliaries.
- ⑥ CA7-9E...23E with electronic coils are not interchangeable with non-electronic DC or AC coils.

**KWIKstarters with CEP7 Overload Relays with I-O Multifunction and E-Stop ①②③④⑤**

Cover Control/ Enclosure	Maximum Horsepower						Total Aux. Contacts Installed		cUL Approved-Type 1/12/4/4X IP66	Dim Code
	Single Ø		Three Ø				NO	NC		
	115V	230V	200V	230V	460V	575V			Catalog Number	
	<b>KWIKstarter with Reset, Multifunction I-O Pushbutton and E-Stop with AC Coil</b>									
	1/2	1 1/2	~	~	~	~	1	0	CBK7-9-*-◆-P0+4U-9	Q1
	~	~	2	2	5	7 1/2			CAK7-9-*-◆-P0+4U-9	
	1/2	2	~	~	~	~	1	0	CBK7-12-*-◆-P0+4U-9	Q1
	~	~	3	3	7 1/2	10			CAK7-12-*-◆-P0+4U-9	
	1	3	~	~	~	~	1	0	CBK7-16-*-◆-P0+4U-9	Q1
	~	~	5	5	10	15			CAK7-16-*-◆-P0+4U-9	
	2	3	~	~	~	~	1	0	CBK7-23-*-◆-P0+4U-9	Q1
~	~	5	7 1/2	15	15			CAK7-23-*-◆-P0+4U-9		

**Coil Codes**

A.C. Coil Code	Voltage Range		Control Source	
	50 Hz	60 Hz	CBK7	CAK7
24Z	24V	24V	Separate	Separate
120	110V	120V	Common	Separate
220W	200-220V	208-240V	Common	Common
277	240V	277V	Common	~
415	400-415V	~	~	Common
480	440V	480V	~	Common
600	550V	600V	~	Common

**Control Circuit Note**

**Common:** Coils and pilot devices in the control circuit are assumed to be common with the line voltage and will be connected to the line source (L1-L2) per the table.

**Separate:** Coils and pilot devices in the control circuit are assumed to be from a separate source and will not be connected to the line source per the table. Line Voltage not listed: (i.e.: 480 and 575 VAC) require a separate control source (i.e.: 120 VAC).

**Ordering Instructions**

Specify Catalog Number	
Replace (*) with Coil Code	<b>See this page See page C30</b>
Replace (◆) with O/L Relay	
<b>Important Note:</b> KWIKstarters (Q1 dim.) are only designed to accommodate Relays or CEP7 Solid State Overload Relays. Select O/L Relay Code from page C30.	

- ① This is a factory assembly. The KS7-C0S1 (Q1) enclosure does not include knock-outs for field assembly of this starter.
- ② Uses D7P-U2EFFEPX11 Two-Position Multifunction push button with legend I/O.
- ③ Uses D7P-MT44PX01 Emergency Stop Push Button.
- ④ Refer to page C33 for wiring and dimensional information. This is a clam-shell enclosure design with wires to cover controls.
- ⑤ There is no room for additional auxiliaries.



### Three Phase Reversing KWIKstarters with CEP7 Overload Relays ①

Enclosure (KS7-COS4R)	Maximum Horsepower				Auxiliary Contacts per Contactor ⑦		cUL Approved-Type 1/12/4/4X IP66	Dimension Code ⑧
	Three Ø				NO	NC		
	200V	230V	460V	575V			Catalog Number	
	FVR 3-Phase with AC Coil							
	2	2	5	7 1/2	1	1	CAUK7-9-*-◆-P▼	Q3
	3	3	7 1/2	10	1	1	CAUK7-12-*-◆-P▼	Q3
	5	5	10	15	1	1	CAUK7-16-*-◆-P▼	Q3
	5	7 1/2	15	15	1	1	CAUK7-23-*-◆-P▼	Q3



### Coil Codes (\*) ④⑥

A.C. Coil Code	Voltage Range		Control Source	
	50 Hz	60 Hz	CBK7	CAK7
24Z	24V	24V	Separate	Separate
120	110V	120V	Common	Separate
220W	200-220V	208-240V	Common	Common
277	240V	277V	Common	~
415	400-415V	~	~	Common
480	440V	480V	~	Common
600	550V	600V	~	Common

### Control Circuit Note

**Common:** Coils and pilot devices in the control circuit are assumed to be common with the line voltage and will be connected to the line source (L1-L2) per the table.

**Separate:** Coils and pilot devices in the control circuit are assumed to be from a separate source and will not be connected to the line source per the table. Pilot lights are 240 VAC maximum.

### Pilot Device Options (includes reset) ②③

Pushbutton Description	Replace ▼ in catalog number with
FOR-STOP-REV Multi-function (shown)	3U
UP-STOP-DOWN Multi-function	4U
OPEN-STOP-CLOSE Multi-function	5U
FOR-STOP-REV 3-Position Selector switch	6
UP-OFF-DOWN 3-Position Selector switch	7
OPEN-OFF-CLOSE 3-Position Selector switch	8
Overload Alarm Pilot Light	1Y
D7-N8 22mm Hole Plug	0

### Optional CA7 Modifications (Factory Assembled) \*

Description (supplied on each contactor)	Add to end of catalog number
Electronic Interface	-2JE
Surge Suppressor RD	-2C
Surge Suppressor Varistor	-2V

\* List Price Adder applies

### Replace ◆ with one of the following Overload Relays

For use with KWIKstarter...	Amp Range	Overload Relay Code (◆)	Catalog Number (of Overload Relay used)
1-Phase & 3-Phase / Manual Reset / Class 10 or 20			
CAUK7-9...23 CAUK7-9E...23E	0.1...0.5	1EAB	CEP7-1EEAB
	0.2...1.0	1EBB	CEP7-1EEBB
	1.0...5.0	1ECB	CEP7-1EECB
	3.2...16	1EDB	CEP7-1EEDB
	5.4...27	1EEB	CEP7-1EEEB
1-Phase & 3-Phase / Auto or Manual Reset / Class 10...30 *			
CAUK7-9...23 CAUK7-9E...23E	0.1...0.5	FAB	CEP7-1EFAB
	0.2...1.0	FBB	CEP7-1EFBB
	1.0...5.0	FCB	CEP7-1EFCB
	3.2...16	FDB	CEP7-1EFDB
	5.4...27	FEB	CEP7-1EFEB

\* List Price Adder applies

### Ordering Instructions

Specify Catalog Number	
Replace (*) with Coil Code	See this page only
Replace (◆) with O/L Relay	
Replace (▼) with Pilot Device Option	

- ① Use CEP7-1\_\_ overloads only – and also backward compatible to CEP7-ED1/EE.
- ② Plastic Bezel is standard. Pilot Device options include D7-BX\_ Base Mounted contact blocks. See page H69 for more information.
- ③ Refer to page C32 for wiring diagram and C34 for dimensional information.
- ④ Other voltages available, see Section A.
- ⑤ One Pilot Device option must be selected. Blanks are not available. If Pilot Light option is selected then coil voltage must be 24V, 120V or 240V AC only.
- ⑥ CPT not possible with KS7-COS4R (Q3) enclosure.
- ⑦ One N.C. auxiliary contact is used for electrical interlocking. On CAUK7 reversing starters, the N.C. contact comes from the Mechanical/Electrical Interlock unit (Cat# CM7-02).

### Three Phase Reversing KWIKstarters with CEP7 Overload Relays ①

Enclosure (KS7-C0S4R)	Maximum Horsepower				Auxiliary Contacts per Contactor ⑦		cUL Approved- Type 1/12/4/4X IP66	Dimen- sion Code
	Three Ø							
	200V	230V	460V	575V	NO	NC	Catalog Number	③
	<b>FVR 3-Phase with Electronic DC Coil</b>							
	2	2	5	7 1/2	1	1	CAUK7-9E-*-*♦-P▼	Q3
	3	3	7 1/2	10	1	1	CAUK7-12E-*-*♦-P▼	Q3
	5	5	10	15	1	1	CAUK7-16E-*-*♦-P▼	Q3
	5	7 1/2	15	15	1	1	CAUK7-23E-*-*♦-P▼	Q3



**C**  
KWIKstarters

### Coil Codes ④⑥

D.C. Coil Code	Voltage Range
	VDC
12E	12V
24E	24V
36E	36-48V
48E	48-72V
110E	110-125V
220E	220-250V

### Replace ♦ with one of the following Overload Relays

For use with KWIKstarter...	Amp Range	Overload Relay Code (♦)	Catalog Number (of Overload Relay used)
<b>1-Phase &amp; 3-Phase / Manual Reset / Class 10 or 20</b>			
CAUK7-9...23 CAUK7-9E...23E	0.1...0.5	1EAB	CEP7-1EEAB
	0.2...1.0	1EBB	CEP7-1EEBB
	1.0...5.0	1ECB	CEP7-1EECB
	3.2...16	1EDB	CEP7-1EEDB
	5.4...27	1EEB	CEP7-1EEEB
<b>1-Phase &amp; 3-Phase / Auto or Manual Reset / Class 10...30 *</b>			
CAUK7-9...23 CAUK7-9E...23E	0.1...0.5	FAB	CEP7-1EFAB
	0.2...1.0	FBB	CEP7-1EFBB
	1.0...5.0	FCB	CEP7-1EFCB
	3.2...16	FDB	CEP7-1EFDB
	5.4...27	FEB	CEP7-1EFEB

\* List Price adder applies

### Pilot Device Options (includes reset) ②③

Pushbutton Description	Replace ▼ in catalog number with
FOR-STOP-REV Multi-function (shown)	3U
UP-STOP-DOWN Multi-function	4U
OPEN-STOP-CLOSE Multi-function	5U
FOR-STOP-REV 3-Position Selector switch	6
UP-OFF-DOWN 3-Position Selector switch	7
OPEN-OFF-CLOSE 3-Position Selector switch	8
Overload Alarm Pilot Light	1Y
D7-N8 22mm Hole Plug	0

### Optional CA7 Modifications (Factory Assembled) \*

Description (supplied on each contactor)	Add to end of catalog number
Electronic Interface	-2JE
Surge Suppressor RD	-2C
Surge Suppressor Varistor	-2V





\* List Price adder applies

### Ordering Instructions

Specify Catalog Number	<b>See this page only</b>
Replace (*) with Coil Code	
Replace (♦) with O/L Relay	
Replace (▼) with Pilot Device Option	

- ① Use CEP7-1\_\_ overloads only – and also backward compatible to CEP7-ED1/EE.
- ② Plastic Bezel is standard. Pilot Device options include D7-BX\_ Base Mounted contact blocks. See page H69 for more information.
- ③ Refer to page C32 for wiring diagram and C34 for dimensional information.
- ④ CA7-9E...55E with electronic coils are not interchangeable with non-electronic DC or AC coils.
- ⑤ One Pilot Device option must be selected. Blanks are not available. If Pilot Light option is selected then coil voltage must be 24V DC only.
- ⑥ CPT not possible with KS7-C0S4R (Q3) enclosure.
- ⑦ One N.C. auxiliary contact is used for electrical interlocking. On CAUK7 reversing starters, the N.C. contact comes from the Mechanical/Electrical Interlock unit (Cat# CM7-02).

#### NEMA KWIKstarters with CT7N or CEP7 Overload Relays ①⑥

Cover Control/ Enclosure (KS7-COS1/COS4)	NEMA Size	Maximum Horsepower						Total Aux. Contacts Installed		cUL Approved- Type 1/12/4/4X IP66	Dimension Code
		Single Ø		Three Ø				NO	NC		
		115V	230V	200V	230V	460V	575V			Catalog Number	
	<b>KWIKstarter with Start &amp; Raised Stop with AC Coil ④⑤</b>										
	00	1/3	1	~	~	~	~	1 ②	0	CBKN7-12-*-◆-P2 CAKN7-12-*-◆-P2	Q1
	0	1	2	~	~	~	~	1 ②	0	CBKN7-16-*-◆-P2 CAKN7-16-*-◆-P2	Q1
	~	~	~	1-1/2	1-1/2	2	2				
	~	~	~	3	3	5	5				
	~	~	~	~	~	~	~				
	<b>KWIKstarter with Start &amp; Raised Stop with Electronic DC Coil ⑦</b>										
	00	1/3	1	~	~	~	~	1 ②	0	CBKN7-12E-*-◆-P2 CAKN7-12E-*-◆-P2	Q1
	0	1	2	~	~	~	~	1 ②	0	CBKN7-16E-*-◆-P2 CAKN7-16E-*-◆-P2	Q1
	~	~	~	1-1/2	1-1/2	2	2				
	~	~	~	3	3	5	5				
	~	~	~	~	~	~	~				
	<b>KWIKstarter with Reset with AC Coil</b>										
	00	1/3	1	~	~	~	~	1 ②	0	CBKN7-12-*-◆-P0 CAKN7-12-*-◆-P0	Q1
	0	1	2	~	~	~	~	1 ②	0	CBKN7-16-*-◆-P0 CAKN7-16-*-◆-P0	Q1
	~	~	~	1-1/2	1-1/2	2	2				
	~	~	~	3	3	5	5				
	~	~	~	~	~	~	~				
	<b>KWIKstarter with Reset with Electronic DC Coil ⑦</b>										
	00	1/3	1	~	~	~	~	1 ②	0	CBKN7-12E-*-◆-P0 CAKN7-12E-*-◆-P0	Q1
	0	1	2	~	~	~	~	1 ②	0	CBKN7-16E-*-◆-P0 CAKN7-16E-*-◆-P0	Q1
	~	~	~	1-1/2	1-1/2	2	2				
	~	~	~	3	3	5	5				
	~	~	~	~	~	~	~				

#### Coil Codes ⑤⑦

A.C. Coil Code	Voltage Range		Control Source	
	50 Hz	60 Hz	CBK7	CAK7
24Z	24V	24V	Separate	Separate
120	110V	120V	Common	Separate
208	~	208V	~	Common
220W	200V-220V	208V-240V	Common	Common
240	220V	240V	Common	Common
277	240V	277V	Common	~
380	380V-400V	440V	~	Common
480	440V	480V	~	Common
600	550V	600V	~	Common
D.C. Coil Code	Voltage Range			
	VDC			
12E	12V			
24E	24V			

#### Control Circuit Note

**Common:** Coils are assumed to be common with the line voltage and will be connected to the line source (L1-L2) per the table.

**Separate:** Coils are assumed to be from a separate source and will not be connected to the line source per the table.

#### Ordering Instructions

Specify Catalog Number	
Replace (*) with Coil Code	<b>See this page See page C30</b>
Replace (◆) with O/L Relay	
<b>Important Note:</b> KWIKstarters are only designed to accommodate CT7N Thermal Overload Relays or CEP7 Solid State Overload Relays. Select O/L Relay Code from page C30.	

- ① KWIKstarters are designed for three-wire control circuits. Two-wire (maintain) control can be accomplished by adding pushbutton latch KS7-PLA.
- ② A special design NO auxiliary contact (Cat.# KS7-PCK) is used as the holding circuit interlock, as well as, the START button interface. It is not available for other use.
- ③ Refer to page C33 for dimensional information.
- ④ STOP button also functions as RESET button. Plastic Bezel is standard.
- ⑤ Other voltages available, see Section A.
- ⑥ Use CT7N or CEP7-ED/CEP7-EE overload.
- ⑦ CAN7-12E...16E with electronic coils are not interchangeable with non-electronic DC or AC coils.

#### NEMA KWIKstarters with CT7N or CEP7 Overload Relays with H-O-A and Light ①②③④⑤⑥

Cover Control/ Enclosure (KS7-COS1)	NEMA Size	Maximum Horsepower						Total Aux. Contacts Installed		cUL Approved-Type 1/12/4/4X IP66	Dimension Code
		Single Ø		Three Ø				NO	NC		
		115V	230V	200V	230V	460V	575V			Catalog Number	
<b>NEMA KWIKstarter with Reset and H-O-A Selector Switch and Light with AC Coil</b>											
00	1/3	1	~	~	~	~	1 ⑤	0	CBKN7-12-*-◆-P0+1R7		Q1
	~	~	1-1/2	1-1/2	2	2			CAKN7-12-*-◆-P0+1R7		
0	1	2	~	~	~	~	1 ⑤	0	CBKN7-16-*-◆-P0+1R7		Q1
	~	~	3	3	5	5			CAKN7-16-*-◆-P0+1R7		
<b>NEMA KWIKstarter with Reset and H-O-A Selector Switch and Light with Electronic DC Coil ⑦</b>											
00	1/3	1	~	~	~	~	1 ⑤	0	CBKN7-12E-*-◆-P0+1R7		Q1
	~	~	1-1/2	1-1/2	2	2			CAKN7-12E-*-◆-P0+1R7		
0	1	2	~	~	~	~	1 ⑤	0	CBKN7-16E-*-◆-P0+1R7		Q1
	~	~	3	3	5	5			CAKN7-16E-*-◆-P0+1R7		

KWIKstarters



#### Coil Codes ⑦

A.C. Coil Code	Voltage Range		Control Source	
	50 Hz	60 Hz	CBK7	CAK7
24Z	24V	24V	Separate	Separate
120	110V	120V	Common	Separate
208	~	208V	~	Common
220W	200V-220V	208V-240V	Common	Common
240	220V	240V	Common	Common
D.C. Coil Code	Voltage Range			
	VDC			
12E	12V			
24E	24V			

#### Control Circuit Note

**Common:** Coils and pilot devices in the control circuit are assumed to be common with the line voltage and will be connected to the line source (L1-L2) per the table.

**Separate:** Coils and pilot devices in the control circuit are assumed to be from a separate source and will not be connected to the line source per the table. Line Voltage not listed: (i.e.: 480 and 575 VAC) require a separate control source (i.e.: 120 VAC). D7D pilot devices are rated 300 VAC maximum.

#### Ordering Instructions

Specify Catalog Number	
Replace (*) with Coil Code Replace (◆) with O/L Relay	<b>See this page See page C30</b>
<b>Important Note:</b> KWIKstarters are only designed to accommodate CT7N Thermal Overload Relays or CEP7 Solid State Overload Relays. Select O/L Relay Code from page C30.	

- ① This is a factory assembly. The KS7-COS1 (Q1) enclosure does not include knock-outs for field assembly of this starter.
- ② Uses D7D-P4N Red Monolithic "Run" pilot light with LED bulb. Pilot light voltage to match coil voltage for 24, 120, 240 VAC control. Red "Run" Light can be changed for Green. Change +1R7 to +1G7. For example, CAKN7-9-\*-◆-P0+1R7 becomes CAKN7-9-\*-◆-P0+1G7.
- ③ Uses D7D-SM32x20 Monolithic 3-position selector switch for maintain control, HAND-OFF-AUTO function with legend plate.
- ④ Refer to page C32 for wiring and dimensional information. This is a clam-shell enclosure design with wires to cover controls.
- ⑤ Uses CT7N or CEP7-ED/CEP7-EE overload.
- ⑥ One NO auxilliary for customer use. There is no room for additional auxilliaries.
- ⑦ CAN7-12E...16E with electronic coils are not interchangeable with non-electronic DC or AC coils.

NEMA KWIKstarters with CEP7 Overload Relays ①

Enclosure (KS7-C2S4)	NEMA Size	Maximum Horsepower						Total Aux. Contacts Installed		cUL Approved-Type 1/12/4/4X IP66	Dimension Code
		Single Ø		Three Ø				NO	NC		
		115V	230V	200V	230V	460V	575V			Catalog Number	
	NEMA KWIKstarters with AC Coil										
	1	2	3	~	~	~	~	1	0	CBKN7-37-*-ETD-P▼	Q2
		~	~	7-1/2	7-1/2	10	10			CAKN7-37-*-◆-P▼	
	2	3	7-1/2	~	~	~	~	1	0	CBKN7-43-*-ETD-P▼	Q2
		~	~	10	15	25	25			CAKN7-43-*-◆-P▼	
	NEMA KWIKstarters with Electronic DC Coil ④										
	1	3	5	~	~	~	~	1	0	CBKN7-37E-*-ETD-P▼	Q2
		~	~	10	10	25	30			CAKN7-37E-*-◆-P▼	
	2	3	7-1/2	~	~	~	~	1	0	CBKN7-43E-*-ETD-P▼	Q2
		~	~	10	15	30	30			CAKN7-43E-*-◆-P▼	

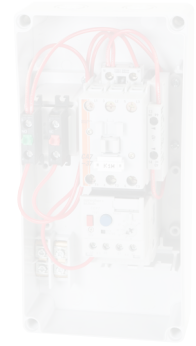

Coil Codes (\*) ④⑤⑦

A.C. Coil Code	Voltage Range		Control Source		D.C. Coil Code	Voltage Range VDC
	50 Hz	60 Hz	CBK7	CAK7		
24Z	24V	24V	Separate	Separate	12E	12V
120	110V	120V	Common	Separate	24E	24V
208	~	208V	~	Common	36E	36V
220W	200V-220V	208V-240V	Common	Common	48-72E	48-72V
240	220V	240V	Common	Common	120E	120V
277	240V	277V	Common	Common	220E	220V
380	380V-400V	440V	~	Common		
480	440V	480V	~	Common		
600	550V	600V	~	Common		

AC Control Circuit Note

Common: Coils and pilot devices in the control circuit are assumed to be common with the line voltage and will be connected to the source (L1 or L2) in the table.  
 Separate: Coils and pilot devices in the control circuit are assumed to be from a separate source and will not be connected to the line source per the table. Pilot lights are 240 VAC maximum.

This page has moved. See new NEMA Starters Section starting at page 101.1

Replace with the following Overload Relays

For use with KWIKstarter...	Amp Range	Overload Relay Code (◆)	Catalog Number (of Overload Relay used)
3-Phase / Manual Reset / Class 10			
CAK7-30...43	1.0...5.0	D1CD	CEP7-ED1CD
	3.2...16	D1DD	CEP7-ED1DD
	5.4...27	D1ED	CEP7-ED1ED
	9...45	D1FD	CEP7-ED1FD
3-Phase / Auto or Manual Reset / Class 10, 15, 20, 30			
CAK7-30...43	1.0...5.0	ECD	CEP7-EECD
	3.2...16	EDD	CEP7-EEED
	5.4...27	EED	CEP7-EEED
	9...45	EFD	CEP7-EEFD

- ① Use CEP7-ED/CEP7-EE overloads only. Single-phase applications utilize CEP7S-EETD only.
- ② Plastic Bezel is standard. Pilot Device options include D7-BX\_ Base Mounted contact blocks. See page H69 for more information.
- ③ Refer to page C31 for wiring diagram and C34 for dimensional information.
- ④ CAN7-37E...43E with electronic coils are not interchangeable with non-electronic DC or AC coils.

Pilot Device Options (includes reset) ②③

Pushbutton Description	Replace ▼ in catalog number with
START-STOP Multi-function (shown)	3U
I-O Multi-function	4U
OFF-ON 2-Position Selector switch	6
Pilot Light Red (LED) with START-STOP Multi-function	1R3U
Pilot Light Red (LED) with I-O Multi-function	1R4U

Optional CA7 Modifications (Factory Assembled)

Description	Add to end of catalog number
Electronic Interface	-JE
Surge Suppressor RD	-C
Surge Suppressor Varistor	-V
Additional NC Contact	-L01
Additional NO Contact	-L10

Ordering Instructions

Specify Catalog Number	
Replace (*) with Coil Code	See this page only
Replace (◆) with O/L Relay	
Replace (▼) with Pilot Device Option	

- ⑤ Other voltages available, see Section A.
- ⑥ One - and only one Pilot Device option must be selected. If Pilot Light option is selected then coil voltage must be 24V AC or DC, 120V or 240V AC only.
- ⑦ CPT not possible with KS7-C2S4 (Q2) enclosure.

Three Phase Reversing NEMA KWIKstarters with CEP7 Overload Relays ①

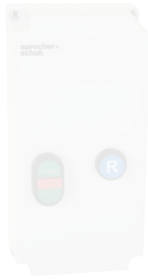
Enclosure (KS7-COS4R)	NEMA Size	Maximum Horsepower				Total Aux. Contacts Installed		cUL Approved-Type 1/12/4/4X IP66	Dimension Code ⑤
		Three Ø				NO	NC		
		200V	230V	460V	575V			Catalog Number	
	3-Phase FVR NEMA KWIKstarter with AC Coil								
	00	1-1/2	1-1/2	2	2	1	1	CAUKN7-12-*-◆-P▼	Q3
	0	3	3	5	5	1	1	CAUKN7-16-*-◆-P▼	Q3
	3-Phase FVR NEMA KWIKstarter with Electronic DC Coil								
	00	1-1/2	1-1/2	2	2	1	1	CAUKN7-12E-*-◆-P▼	Q3
	0	3	3	5	5	1	1	CAUKN7-16E-*-◆-P▼	Q3

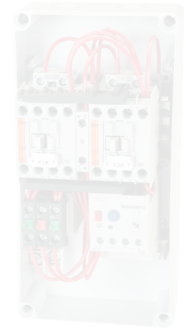

KWIKstarters

Coil Codes (\*) ④⑤⑦

A.C. Coil Code	Voltage Range		Control Source		D.C. Coil Code	Voltage Range VDC
	50 Hz	60 Hz	CBK7	CAK7		
24Z	24V	24V	Separate	Separate	12E	12V
120	110V	120V	Common	Separate	24E	24V
220W	200-220V	208-240V	Common	Common	48E	24-250V
277	240V	277V	Common	~	220E	24-250V
415	400-415V	~	~	Common	~	~
480	440V	480V	~	~	~	~
600	550V	600V	~	~	~	~

AC Control Circuit Note

Common: Coils and pilot devices in the control circuit are assumed to be common with the line voltage and will be connected to the line source (L2) per the table. Non-common coils and pilot devices in the control circuit are assumed to be from a separate source and will not be connected to the line source. Pilot lights are 240 VAC maximum.

This page has moved. See new NEMA Starters Section starting at page 101.1

Pilot Device Options (if reset) ②③

Push Button Description	Replace in catalog number with
FOR-STOP-REV Multi-function (shown)	3U
UP-STOP-DOWN Multi-function	4U
OPEN-STOP-CLOSE Multi-function	5U
FOR-STOP-REV 3-Position Selector switch	6
UP-OFF-DOWN 3-Position Selector switch	7
OPEN-OFF-CLOSE 3-Position Selector switch	8
Overload Alarm Pilot Light	1Y
D7-N8 22mm Hole Plug	0

Optional CA7 Modifications (Factory Assembled)

Description (supplied on each contactor)	Add to end of catalog number
Electronic Interface	-2JE
Surge Suppressor RD	-2C
Surge Suppressor Varistor	-2V

Ordering Instructions



Specify Catalog Number	See this page only
Replace (*) with Coil Code	
Replace (◆) with O/L Relay	
Replace (▼) with Pilot Device Option	

Replace ◆ with one of the following Overload Relays



For use with KWIKstarter...	Amp Range	Overload Relay Code (◆)	Catalog Number (of Overload Relay used)
3-Phase / Manual Reset / Class 10			
CAUKN7-12..16 CAUKN7-12E..16E	0.1...0.5	D1AB	CEP7-ED1AB
	0.2...1.0	D1BB	CEP7-ED1BB
	1.0...5.0	D1CB	CEP7-ED1CB
	3.2...16	D1DB	CEP7-ED1DB
CAUKN7-12..16 CAUKN7-12E..16E	5.4...27	D1EB	CEP7-ED1EB
	3-Phase / Auto or Manual Reset / Class 10, 15, 20, 30		
	0.1...0.5	EAB	CEP7-EEAB
	0.2...1.0	EBB	CEP7-EEBB
CAUKN7-12..16 CAUKN7-12E..16E	1.0...5.0	ECB	CEP7-EECB
	3.2...16	EDB	CEP7-EEDB
	5.4...27	EEB	CEP7-EEEB

- ① Use CEP7-ED/CEP7-EE overloads only.
- ② Plastic Bezel is standard. Pilot Device options include D7-BX\_ Base Mounted contact blocks. See page H69 for more information.
- ③ Refer to page C32 for wiring diagram and C34 for dimensional information.
- ④ CAN7-12E...16E with electronic coils are not interchangeable with non-electronic DC or AC coils.
- ⑤ Other voltages available, see Section A.
- ⑥ One Pilot Device option must be selected. Blanks are not available. If Pilot Light option is selected then Pilot Light must match Coil Voltage 24V AC or DC, 120V or 240V AC only.
- ⑦ CPT not possible with KS7-COS4R (Q3) enclosure.
- ⑧ One N.C. auxiliary contact is used for electrical interlocking. On CAUKN7 reversing starters, the N.C. contact comes from the Mechanical/Electrical Interlock unit (Cat# CM7-02).

**KWIKstarter 9...23A Enclosures with CEP7 Overload Relays ①**

Component	Description	For Use With		Environmental Approvals	Catalog Number
		Contactors	Overload		
	<b>Flush Green START / Extended Red STOP</b> - Mechanical interface auxiliary contact (KS7-PCK) included in enclosure.	CA7-9...23	CEP7-1 ___ B ⑤	cUL Type 1/12/4/4x IEC IP66	<b>KS7-C0S4</b>
	<b>Blue RESET Only</b>	CA7-9...23	CEP7-1 ___ B ⑤	cUL Type 1/12/4/4x IEC IP66	<b>KS7-C0S1</b>

**KWIKstarter Enclosures for use with CA7 Contactors and Overload Relays ①④**

Component	Description	For Use With		Environmental Approvals	Catalog Number
		Contactors	Overload		
	<b>Enclosure for KWIKstarter ②</b> CAK7/CBK7-30...43 CAK7/CBK7-30E...43E	CA7-30...43 CA7-30E...43E	CEP7-1 ___ D ⑥	cUL Type 1/12/4/4x IEC IP66	<b>KS7-C2S4</b>
	<b>Enclosure for Reversing KWIKstarter ③</b> CAUK7-9...23 CAUK7-9E...23E	CAU7-9...23 CAU7-9E...23E	CEP7-1 ___ B ⑤	cUL Type 1/12/4/4x IEC IP66	<b>KS7-C0S4R</b>

① KWIKstarters are only designed to accommodate CA7-9...43 contactors with CEP7 Solid State Overload Relays. If ordering components, select contactor from Section A and overload relay from Section B in this catalog.



② KWIKstarter enclosure KS7-C2S4 are designed to fit CA7-30(E)...43(E) contactors with CEP7 Overload Relays. CT7N Thermal Overloads can not be substituted.

③ KWIKstarter enclosure KS7-C0S4R are designed to fit CAU7-9(E)...23(E) reversing contactors with CEP7 Overload Relays. CT7N Thermal Overloads can not be substituted.

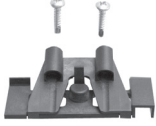

④ KS7-C2S4 and KS7-C0S4R are supplied with two 22mm holes for Pilot Devices. A Reset is required and one additional pilot device kit from page C29 must be selected. Use of a CPT is not possible.

⑤ KS7-C\_ Series B enclosures are compatible to 3rd gen CEP7-1 and 2nd gen CEP7-ED1/EE.  
KS7-C\_ Series A enclosures (obsolete) are compatible to 2nd gen CEP7-ED1/EE.

**KWIKstarter Components with CT7N or CEP7 Overload Relays (for use with KS7-COS1/KS7-COS4)**

Component	Description	For Use With...	Catalog Number
	<b>Start - Contact kit</b> Specially designed NO auxiliary; mechanically interfaces with the START button. Mounts on right side. A KS7-PCK is included in every KS7-COS4 enclosure.	KS7-COS4 (Replacement Part)	<b>KS7-PCK</b>
	<b>Pushbutton Latch -</b> For maintain contact control (2-wire control)	KS7-COS4	<b>KS7-PLA</b>
	<b>Neutral Terminal</b>	KS7-COS1 KS7-COS4	<b>KS7-PNT</b>
	<b>Grounding Kit</b> (for use with metal conduit)	All KWIKstarter enclosures	<b>KS7-GR1</b>

**KWIKstarter Pilot Device Kits (for use with KS7-C2S4/KS7-COS4R) ❶**

Kits	Description	For Use With Enclosure...	Contact Blocks included		Catalog Number
			NO	NC	
	<b>Multi-Function Pushbutton kit</b> Non-illuminated <b>START-STOP</b> <b>I-O</b>	KS7-C2S4 Type 1, 12, 4, 4X	1	1	<b>KS7-P3U</b> <b>KS7-P4U</b>
	<b>FOR-STOP-REV</b> <b>UP-STOP-DOWN</b> <b>OPEN-STOP-CLOSE</b>	KS7-COS4R Type 1, 12, 4, 4X	2	1	<b>KS7-P3U-REV</b> <b>KS7-P4U-REV</b> <b>KS7-P5U-REV</b>
	<b>Selector switch kits</b> Non-illuminated, includes legend plate <b>ON-OFF 2-Position</b>	KS7-C2S4 Type 1, 12, 4, 4X	1	-	<b>KS7-P6</b>
	<b>FOR-OFF-REV 3-Position</b> <b>UP-OFF-DOWN 3-Position</b> <b>OPEN-OFF-CLOSE 3-Position</b>	KS7-COS4R Type 1, 12, 4, 4X	2	-	<b>KS7-P6-REV</b> <b>KS7-P7-REV</b> <b>KS7-P8-REV</b>
	<b>Reset Pushbutton, Blue</b> Plastic push button, flush operator with Blue Cap and R text	KS7-C2S4 KS7-COS4	Black Plastic with Blue Cap and White "R"		<b>D7P-F611</b> ❷

❶ Plastic bezel is standard. Pilot Device Kits include D7-BX\_ Base Mounted contact blocks. See page H69 for more information.

❷ D7P-R611 and CEP7-1ERA can not be used with KS7-C2S4 or KS7-COS4R. See Section H for more information.



**KWIKstarters with CEP7 Solid State Overload Relay**

For use with KWIKstarter...	Amp Range	Overload Relay Code (◆)	Catalog Number (of Overload Relay used)
<b>1-Phase &amp; 3-Phase / Manual Reset / Class 10 or 20</b>			
CAK7/CBK7-9...23 CAK7/CBK7-9E...23E CAUK7-9...23 CAUK7-9E...23E	0.1...0.5	<b>1EAB</b>	CEP7-1EEAB
	0.2...1.0	<b>1EBB</b>	CEP7-1EEBB
	1.0...5.0	<b>1ECB</b>	CEP7-1EECB
	3.2...16	<b>1EDB</b>	CEP7-1EEDB
	5.4...27	<b>1EEB</b>	CEP7-1EEEB
<b>1-Phase &amp; 3-Phase / Auto or Manual Reset / Class 10...30</b>			
CAK7/CBK7-9...23 CAK7/CBK7-9E...23E CAUK7-9...23 CAUK7-9E...23E	0.1...0.5	<b>FAB</b>	CEP7-1EFAB
	0.2...1.0	<b>FBB</b>	CEP7-1EFBB
	1.0...5.0	<b>FCB</b>	CEP7-1EFCB
	3.2...16	<b>FDB</b>	CEP7-1EFDB
	5.4...27	<b>FEB</b>	CEP7-1EFEB

**KWIKstarters**

◆ CEP7 Overloads are available for use in KWIKStarters if the premium features are required (see Section B).

### KWIKstarter (in enclosure KS7-COS1/COS4)

CUSTOMER MUST PROVIDE PROPER BRANCH CIRCUIT PROTECTION (F1)  
SEE THE APPLICATION INSTRUCTION SHEET - COMPONENT SELECTION TABLES  
FOR MAX. FUSE SIZE & CLASS AND APPLICABLE SHORT CIRCUIT RATING  
(USE 75°C COPPER WIRE ONLY)

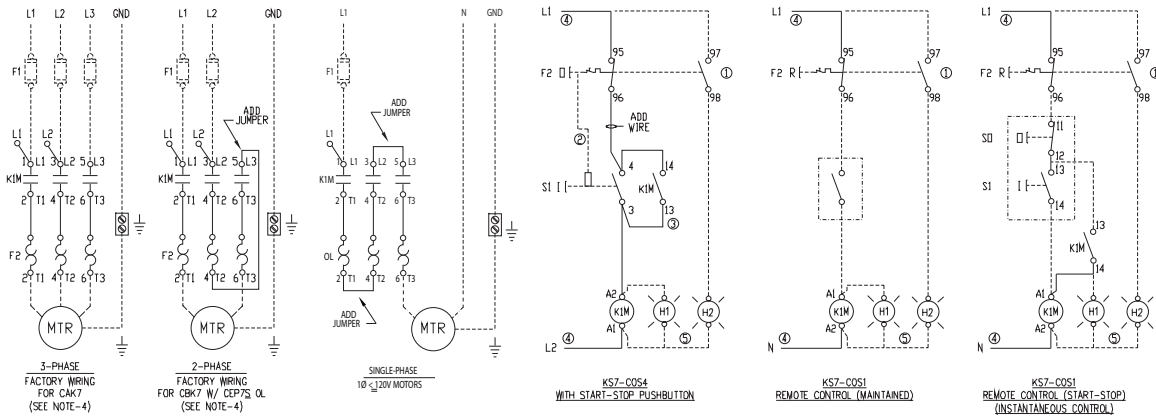

THIS DRAWING IS FOR THE FOLLOWING ENCLOSURES:  
KS7-COS4 with integrated START-STOP push buttons  
KS7-COS1 with integrated RESET push button

**NOTES:**

- 1) MECHANICAL LATCH KS7-PLA FOR MAINTAINED CONTROL (OPTIONAL).
- 2) START CONTACT KIT KS7-PCK (INCLUDED) MOUNTS ON THE RIGHT SIDE WITH MOLDED PRE-FORMED JUMPERS.
- 3) DO NOT WIRE CONTROLS CIRCUIT TO LINE SIDE OF CONTACTOR WHEN COIL VOLTAGE IS 120V OR LESS. (FACTORY WIRING STANDARD)
- 4) OPTIONAL PILOT LIGHTS.

### KWIKstarter (in enclosure KS7-C2S4)

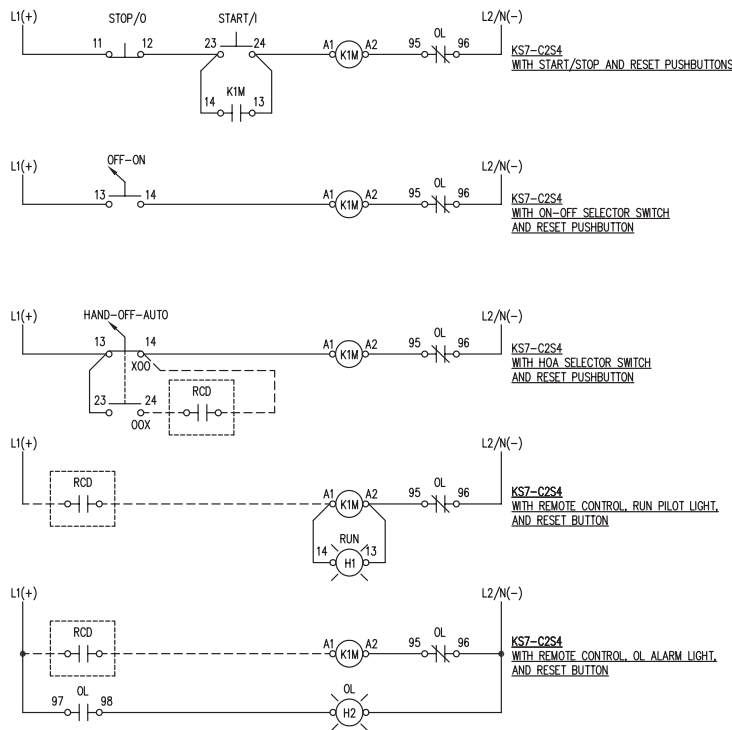

CUSTOMER WILL PROVIDE BRANCH CIRCUIT PROTECTION (F1)  
SEE THE APPLICATION INSTRUCTION SHEET - COMPONENT SELECTION TABLES  
FOR MAX. FUSE SIZE, CLASS, AND APPLICABLE SHORT CIRCUIT RATING  
(USE 75°C COPPER WIRE ONLY)

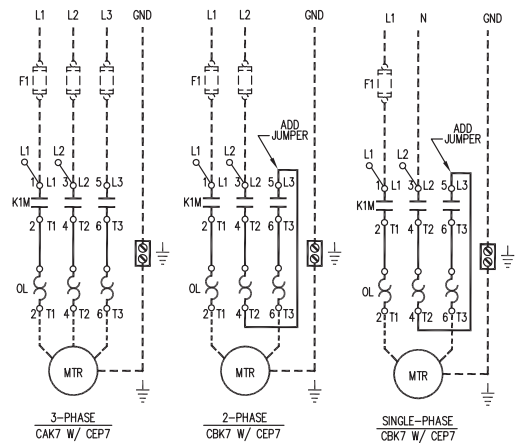

**NOTES:**

1. DO NOT CONNECT A1-A2 TO L1-L2 UNLESS COIL VOLTAGE MATCHES LINE VOLTAGE
2. PILOT LIGHTS POSSIBLE FOR REMOTE OR OVERLOAD ALARM IF NO START/STOP CONTROL DEVICES IN COVER
3. RCD = REMOTE CONTROL DEVICE (BY OTHERS)

### Reversing KWIKstarter (in enclosure KS7-C0S4R)

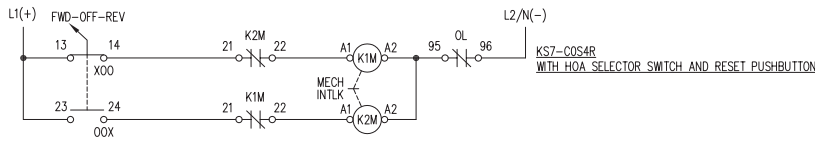
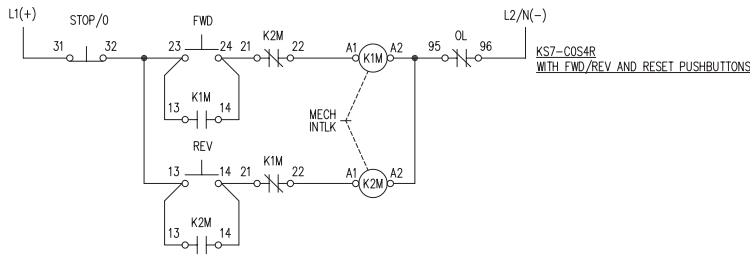

NOTE:  
DO NOT CONNECT A1-A2 TO L1-L2 UNLESS COIL VOLTAGE MATCHES LINE VOLTAGE

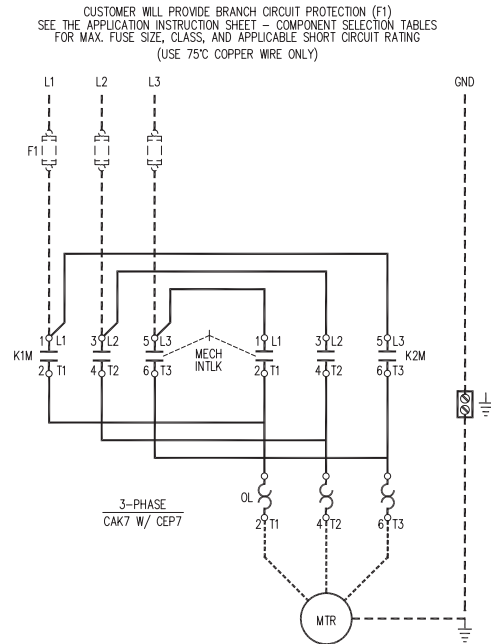

### KWIKstarter (in enclosure KS7-C0S1) with HOA option

HAND-OFF-AUTO with Pilot Light

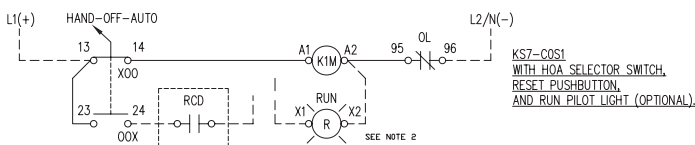
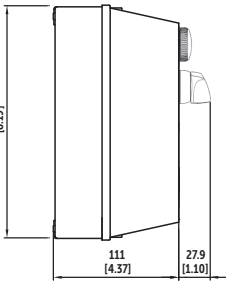

CUSTOMER WILL PROVIDE BRANCH CIRCUIT PROTECTION (F1)  
SEE THE APPLICATION INSTRUCTION SHEET - COMPONENT SELECTION TABLES  
FOR MAX. FUSE SIZE, CLASS, AND APPLICABLE SHORT CIRCUIT RATING  
(USE 75°C COPPER WIRE ONLY)

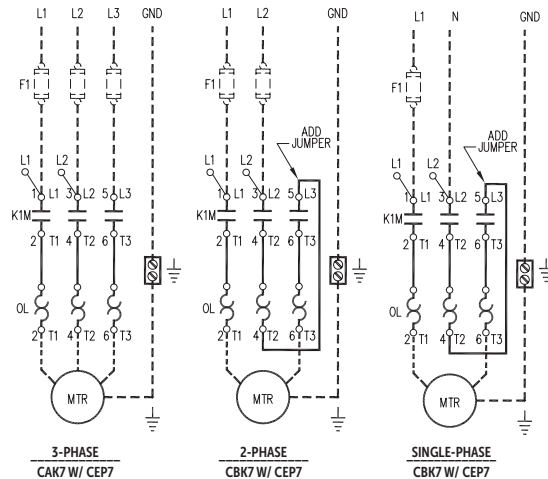

A.C. Coil Code	Voltage Range		Control Source	
	50 Hz	60 Hz	CBK7	CAK7
24Z	24V	24V	Separate	Separate
120	110V	120V	Common	Separate
208	~	208V	~	Common
220W	200V-220V	208V-240V	Common	Common
240	220V	240V	Common	Common
D.C. Coil Code	Voltage Range		Control Source	
	VDC		CBK7	CAK7
12E	12V		Separate	Separate
24E	24V		Separate	Separate

NOTES:

- RCD = REMOTE CONTROL DEVICE (BY OTHERS). WIRE RCD TO TERMINAL 24 ON THE H-O-A SEL. SW. AND TERMINAL A1 ON THE CONTACTOR.
- DASHED LINES ----- INDICATE WIRING PROVIDED IN THE FIELD.

## KWIKstarter (in enclosure KS7-COS1) with Emergency Stop option

EMERGENCY STOP with MULTI-FUNCTION

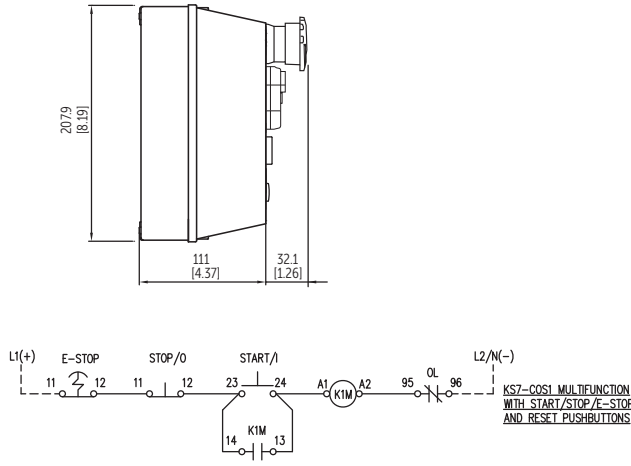

A.C. Coil Code	Voltage Range		Control Source	
	50 Hz	60 Hz	CBK7	CAK7
<b>24Z</b>	24V	24V	Separate	Separate
<b>120</b>	110V	120V	Common	Separate
<b>208</b>	~	208V	~	Common
<b>220W</b>	200V-220V	208V-240V	Common	Common
<b>240</b>	220V	240V	Common	Common

CUSTOMER WILL PROVIDE BRANCH CIRCUIT PROTECTION (F1)  
SEE THE APPLICATION INSTRUCTION SHEET - COMPONENT SELECTION TABLES  
FOR MAX. FUSE SIZE, CLASS, AND APPLICABLE SHORT CIRCUIT RATING  
(USE 75°C COPPER WIRE ONLY)

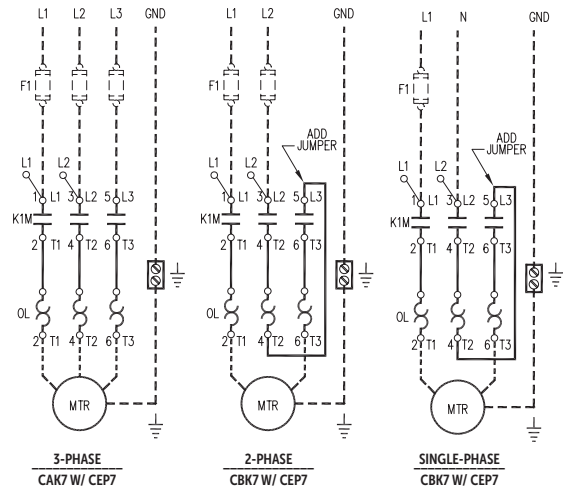

## KWIKstarter Enclosure KS7-COS1/COS4 (Dimension Code Q1)

Dimensions are in millimeters (inches). Dimensions not intended for manufacturing purposes.

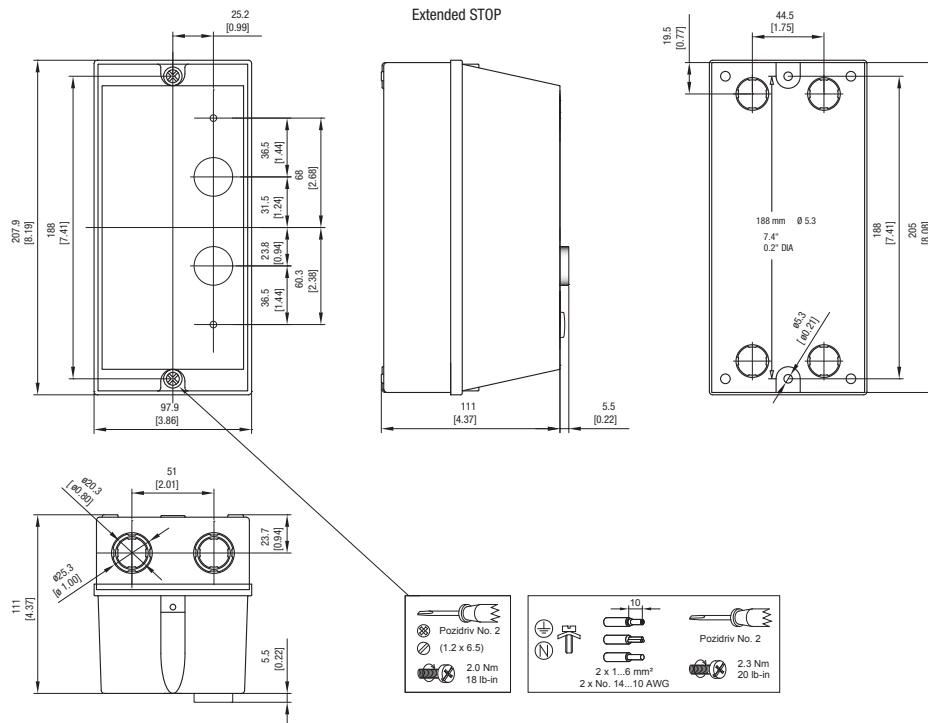

**KWIKstarter Enclosure KS7-C2S4 (Dimension Code Q2)**

Dimensions are in millimeters (inches). Dimensions not intended for manufacturing purposes.

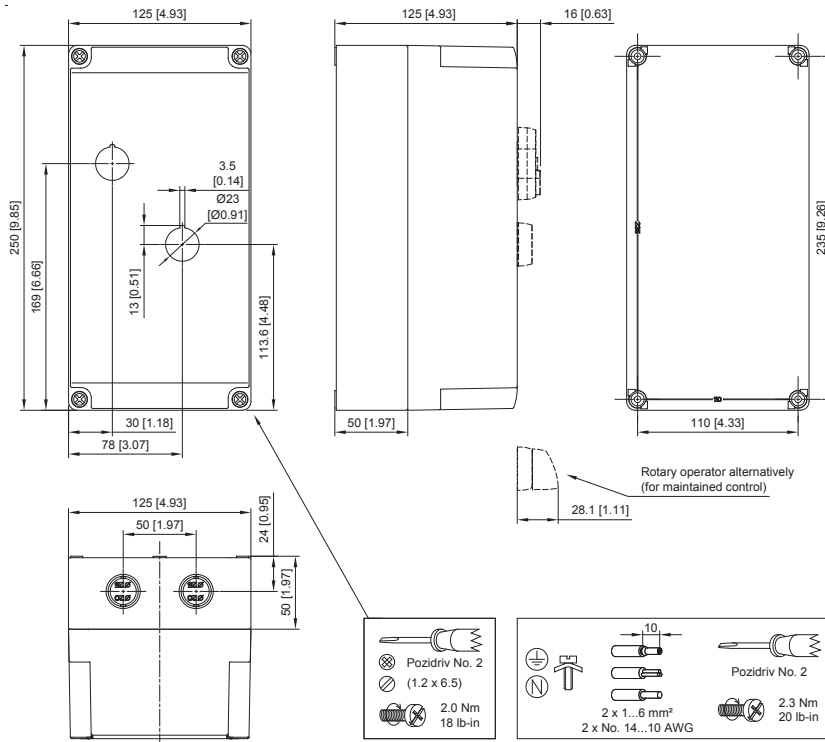

**KWIKstarter Enclosure KS7-C0S4R (Dimension Code Q3)**

