

<b>General Information</b> .....	A2
<i>Horse Power Rating Charts</i> .....	A4
<i>Contact Life</i> .....	A8
<i>Contact Number Structure</i> .....	A11
<b>Series CA8 Miniature Contactors and Starters</b> .....	A13
<i>Accessories</i> .....	A21
<i>Contact Cross Reference</i> .....	A23
<i>Technical Information &amp; Dimensions (Online)</i> .....	A24
<b>Series CA7 Contactors</b> .....	A30
<i>Reversing</i> .....	A37
<i>Special Use CA7 Contactors</i> .....	A40
<i>CNX Special Purpose</i> .....	A41
<i>NEMA Labeled Contactors</i> .....	A42
<i>CA7Y2 Wye-Delta Contactors</i> .....	A44
<i>CAL7 Lighting Rated</i> .....	A45
<i>Accessories</i> .....	A47
<i>Renewal Coils</i> .....	A56
<i>Contact Cross Reference</i> .....	A58
<i>Technical Information &amp; Dimensions (Online)</i> .....	A59
<b>Series CA9 Contactors</b> .....	A90
<i>Accessories</i> .....	A93
<i>Contact Cross Reference</i> .....	A98
<i>Technical Information &amp; Dimensions (Online)</i> .....	A99
<b>Series CA6 Contactors (Discontinued)</b> .....	A120
<i>Accessories</i> .....	A129
<i>Renewal Coils</i> .....	A134
<i>Contact Cross Reference</i> .....	A137
<i>Technical Information &amp; Dimensions (Online)</i> .....	A138
<b>Series CA5 Contactors (Discontinued)</b> .....	A156
<i>Accessories</i> .....	A159
<i>Renewal Coils</i> .....	A161
<i>Technical Information &amp; Dimensions (Online)</i> .....	A163
<b>Series CDP2 Definite Purpose Contactors</b> .....	A178
<i>Accessories</i> .....	A184
<i>Technical Information &amp; Dimensions (Online)</i> .....	A185

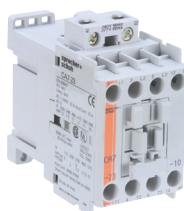

# Contactors – General Purpose and Definite Purpose

A rugged and comprehensive range of contactors from 5 to 900 HP

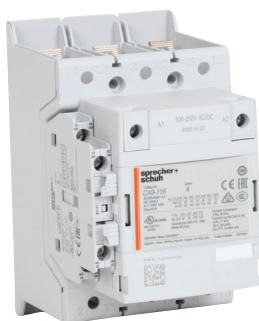

Sprecher+Schuh IEC contactors are designed and manufactured in plants that are quality certified to international standard ISO 9001

Sprecher + Schuh's broad line of general purpose contactors combine performance and reliability in space saving designs that are well proven and used the world over. Sprecher + Schuh's IEC design is dimensionally among the smallest devices in the industry. A range of definite purpose contactors is also available, providing reliable and economic performance in commercial applications.

## Economy and selection

Four different contactor families provide a wide variety of contactor sizes, one for practically every horsepower increment! The ability to select intermediate sizes assures a closer match for your motor and provides economy not found with traditionally sized devices. Definite purpose contactors are available in one, two, three and four pole, up to 90A.

## Precisely match the contactor to the application

Unique to IEC-style contactors is the ability to select the exact device required for a specific application. By identifying the conditions under which the contactor will be used, i.e., resistive loads, reversing, inching and plugging, etc., published "life-curve" data predicts contact life in millions of operations. This information enables you to select the precise contactor for your application... without buying too much or too little.

## Designed for long life

Destructive electrical arcs are common when opening or "breaking" the contacts of larger contactors. Sprecher + Schuh general purpose contactors are designed to dramatically reduce electrical arcing by quickly guiding the arc off of the contacts and into specially designed "arc chutes." This special design divides and eliminates the electrical arcs quickly, significantly increasing contact life and assuring reliable operation.

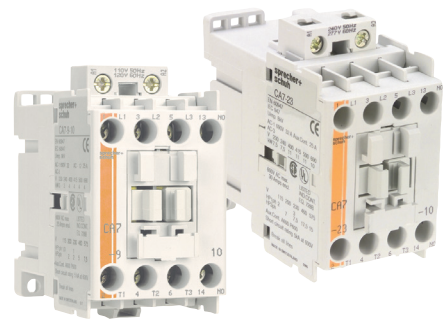

## Limitless choices

A comprehensive selection of modular accessories is available for all contactor families, which allows infinite contactor and starter combinations, both open and enclosed.

## Safety in mind...

Virtually all Sprecher + Schuh contactors are designed to be safe from accidental contact with the finger or back-of-hand. On the smaller contactors, terminals and set screws are recessed, while larger devices (up to Series CA9) accept terminal covers that provide protection according to VDE 0106, Part 100.

## Manufactured to rigorous quality standards

Sprecher + Schuh contactors are designed and manufactured in plants that maintain quality certification to the rigorous international standards, ISO 9001. Sprecher + Schuh manufacturing facilities renew ISO certification every three years by passing an exacting quality assurance audit.

## International standards and approvals

All Sprecher+Schuh IEC contactors are cULus CSA Approved, along with several other certifications. They also carry the CE Mark and meet IEC 60947-1 requirements. They are approved in virtually every international market.

7.5HP 50HP

75HP

900HP

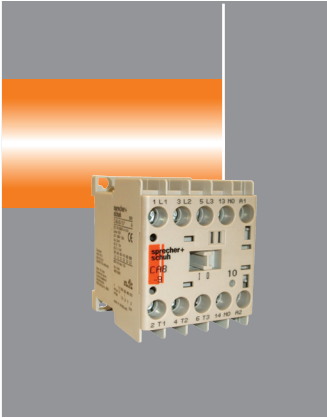

### CA8 Series Contactor

- Provides commercial-grade performance for motors up to 7.5 HP
- Features low-profile design and 45mm width
- Maintains narrow width with modular, snap-on accessories
- Performs up to 700,000 electrical and 15,000,000 mechanical operations



### CA7 Series Contactor

- Covers up to 75HP industrial applications
- Features small dimensions, as little as 45mm wide
- Uses interchangeable accessories for all contactor sizes
- Provides flexibility with reversible coils for group installation
- Has dual-cage clamp lugs on CA7-30 and larger units
- Designed and tested with respect to Type 1 and 2 Coordination



### CA9 Series Contactor

- Covers up to 900HP industrial applications
- Provides a dimensional advantage with a smaller size and footprint
- Features a universal electronic AC/DC coil
- Has various application selections, with IEC solutions up to 2650A
- Includes expanded certifications
- Provides extended life with arc quenching technology



### CDP2 Definite Purpose Contactors

- Covers commercial applications up to 90A / 50HP
- Available in one, two, three and four pole
- Meet or exceed electrical and mechanical requirements defined by definite purpose contactor standards
- Three convenient wire connection methods

Horsepower	AC Induction Motors						
	Single Phase		Three Phase				
	115 Volt	230 Volt	200 Volt	230 Volt	380-415 Volt	460 Volt	575 Volt
	@ 60 HZ	@ 60 HZ	@ 60 HZ	@ 60 HZ	@ 50 HZ	@ 60 HZ	@ 60 HZ
1/6	4.4	2.2	~	~	~	~	~
1/4	5.8	2.9	~	~	~	~	~
1/3	7.2	3.6	~	~	~	~	~
1/2	9.8	4.9	2.5	2.2	1.3	1.1	0.9
3/4	13.8	6.9	3.7	3.2	1.8	1.6	1.3
1	16.0	8.0	4.8	4.2	2.3	2.1	1.7
1 1/2	20.0	10.0	6.9	6.0	3.3	3.0	2.4
2	24.0	12.0	7.8	6.8	4.3	3.4	2.7
3	34.0	17.0	11.0	9.6	6.1	4.8	3.9
5	56.0	28.0	17.5	15.2	9.7	7.6	6.1
7 1/2	80.0	40.0	25.3	22.0	14.0	11.0	9.0
10	100	50.0	32.2	28.0	18.0	14.0	11.0
15	135	68.0	48.3	42.0	27.0	21.0	17.0
20	~	88.0	62.1	54.0	34.0	27.0	22.0
25	~	110	78.2	68.0	44.0	34.0	27.0
30	~	136	92.0	80.0	51.0	40.0	32.0
40	~	176	120	104	66.0	52.0	41.0
50	~	216	150	130	83.0	65.0	52.0
60	~	~	177	154	103	77.0	62.0
75	~	~	221	192	128	96.0	77.0
100	~	~	285	248	165	124	99.0
125	~	~	359	312	208	156	125
150	~	~	414	360	240	180	144
175	~	~	475	413	275	207	168
200	~	~	552	480	320	240	192
250	~	~	692	604	403	302	242
300	~	~	~	722	482	361	289
350	~	~	~	828	560	414	336
400	~	~	~	954	636	477	382
450	~	~	~	1030	711	515	412
500	~	~	~	1180	786	590	472

The information in this chart was derived from Table 50.1 of UL standard 508A. The voltages listed are rated motor voltages. The currents listed shall be permitted for system voltage ranges of 110-120, 220-240, 380-415, 440-480 and 550-600 volts.

The full-load current values are for motors running at usual speeds and motors with normal torque characteristics. Motors built for especially low speeds or high torques may have higher full-load currents, and

multi-speed motors will have full-load currents varying with speed. In these cases, the nameplate current ratings shall be used.

Caution: The actual motor amps may be higher or lower than the average values listed above. For more reliable motor protection, use the actual motor current as listed on the motor nameplate. Use this table as a guide only.

**UL / CSA Maximum HP Rating Selection ①**

Sprecher + Schuh Contactor Series	Maximum Horsepower					
	Single Phase		Three Phase			
	115 Volt	230 Volt	200 Volt	230 Volt	460 Volt	575 Volt
CA7-9	1/2	1 1/2	2	2	5	7-1/2
CA7-12	1/2	2	3	3	7-1/2	10
CA7-16	1	3	5	5	10	15
CA7-23	2	3	5	7-1/2	15	15
CA7-30	2	5	7-1/2	10	20	25
CA7-37	3	5	10	10	25	30
CA7-43	3	7-1/2	10	15	30	30
CA7-55	5	10	15	20	40	40
CA7-60	5	10	15	20	40	50
CA7-72	5	15	20	25	50	60
CA7-85	7-1/2	15	25	30	60	60
CA7-97	10	20	30	30	75	75
CA9-116(-EI)	~	~	30	40	75	100
CA9-146(-EI)	~	~	40	50	100	125
CA9-190(-EI)	~	~	50	60	105	150
CA9-205(-EI)	~	~	60	75	150	200
CA9-265(-EI)	~	~	75	100	200	250
CA9-305(-EI)	~	~	100	125	250	300
CA9-370(-EI)	~	~	125	150	300	350
CA9-400-EI	~	~	125	150	300	400
CA9-460-EI	~	~	150	200	400	500
CA9-580-EI	~	~	200	250	500	600
CA9-750-EI	~	~	~	300	600	700
CA9-860-EI	~	~	~	400	800	1000
CA9-1060-EI	~	~	~	450	900	1150

**NEMA Size Labeled Selection**

NEMA Size	Sprecher + Schuh Contactor Series	Maximum Horsepower					
		Single Phase		Three Phase			
		115V	230V	200V	230V	460V	575V
00	CAN7-12	1/3	1	1-1/2	1-1/2	2	2
0	CAN7-16	1	2	3	3	5	5
1	CAN7-37	2	3	7-1/2	7-1/2	10	10
2	CAN7-43	3	7-1/2	10	15	25	25
3	CAN7-85	7-1/2	15	25	30	50	50

① "EI" designation indicates coil has electronic interface capability with a PLC.

**DC Motor Ratings**

Table 50.2  
Full-load motor-running currents in amperes corresponding to various DC horsepower ratings  
Table 50.2 effective April 25, 2003

Horsepower	90 Volts	110-120 Volts	180 Volts	220-240 Volts	500 Volts	550-600 Volts
1/10	~	2.0	~	1.0	~	~
1/8	~	2.2	~	1.1	~	~
1/6	~	2.4	~	1.2	~	~
1/4	4.0	3.1	2.0	1.6	~	~
1/3	5.2	4.1	2.6	2.0	~	~
1/2	6.8	5.4	3.4	2.7	~	~
3/4	9.6	7.6	4.8	3.8	~	1.6
1	12.2	9.5	6.1	4.7	~	2.0
1-1/2	~	13.2	8.3	6.6	~	2.7
2	~	17	10.8	8.5	~	3.6
3	~	25	16	12.2	~	5.2
5	~	40	27	20	~	8.3
7-1/2	~	58	~	29	13.6	12.2
10	~	76	~	38	18	16
15	~	110	~	55	27	24
20	~	148	~	72	34	31

**Table 139.1 – Rating Codes for AC Control-Circuit Contacts at 50 and 60 Hz ④**

Contact Rating Code Designation ①	Thermal continuous test current Amperes	Maximum current, amperes ②								Maximum volt-Amperes	
		120 Volt		240 Volt		480 Volt		600 Volt			
		Make	Break	Make	Break	Make	Break	Make	Break	Make	Break
A150	10	60	6.00	~	~	~	~	~	~	7200	720
A300	10	60	6.00	30	3.00	~	~	~	~	7200	720
A600	10	60	6.00	30	3.00	15	1.50	12	1.20	7200	720
B150	5	30	3.00	~	~	~	~	~	~	3600	360
B300	5	30	3.00	15	1.50	~	~	~	~	3600	360
B600	5	30	3.00	15	1.50	7.50	0.75	6	0.60	3600	360
C150	2.5	15	1.5	~	~	~	~	~	~	1800	180
C300	2.5	15	1.5	7.5	0.75	~	~	~	~	1800	180
C600	2.5	15	1.5	7.5	0.75	3.75	0.375	3.00	0.30	1800	180
D150	1.0	3.60	0.60	~	~	~	~	~	~	432	72
D300	1.0	3.60	0.60	1.80	0.30	~	~	~	~	432	72
E150	0.5	1.80	0.30	~	~	~	~	~	~	216	36

**Table 139.2 – Rating Codes for DC Control-Circuit Contacts ④**

Contact Rating Code Designation ①	Thermal continuous test current Amperes	Maximum make or break current, Amperes ③			Maximum make or break volt-Amperes at 300 volts or less
		125 Volt	250 Volt	301 to 600 Volt	
N150	10	2.2	~	~	275
N300	10	2.2	1.1	~	275
N600	10	2.2	1.1	0.40	275
P150	5.0	1.1	~	~	138
P300	5.0	1.1	0.55	~	138
P600	5.0	1.1	0.55	0.20	138
Q150	2.5	0.55	~	~	69
Q300	2.5	0.55	0.27	~	69
Q600	2.5	0.55	0.27	0.10	69
R150	1.0	0.22	~	~	28
R300	1.0	0.22	0.11	~	28

- ① The numerical suffix designates the maximum voltage design values, which are to be 600, 300, and 150 volts for suffixes 600, 300, and 150 respectively. Test voltage shall be 600, 250, or 125 volts.
- ② For maximum ratings at voltages between the maximum design value and 120 volts, the maximum make and break ratings are to be obtained by dividing the volt-amperes rating by the application voltage. For voltages below 120 volts, the maximum make current is to be the same as for 120 volts, and the maximum break current is to be obtained by dividing the break volt-amperes by the application voltage, but these currents are not to exceed the thermal continuous test current.
- ③ For maximum ratings at 300 volts or less, the maximum make and break ratings are to be obtained by dividing the volt-ampere rating by the application voltage, but the current values are not to exceed the thermal continuous test current.
- ④ Data tables extracted from UL508 Standards for Industrial Control Equipment.

**Predicting Electrical Life**

Sprecher + Schuh contactors are designed for superior performance in a wide variety of applications, by giving consideration to the specific load, utilization category and required electrical life, you can purchase exactly the type and size of

contactor required. This assures reliable operation and high value the ability to very closely match the contactor to the application.

- ① Identify the appropriate utilization category. For this example, we will determine CA7 contact life for inching and plugging squirrel-cage motors. ❶

Utilization Category	Definition	
AC-1	Resistance Furnaces	Non inductive or slightly inductive loads, Resistive Furnaces
AC-2	Slip-ring motors	Starting and stopping of running motors
AC-3	Squirrel-cage motors	Starting and stopping of running motors
AC-4	Squirrel-cage motors	Starting, plugging, and inching (Plugging is understood as stopping or reversing the motor rapidly by reversing the motor primary connections while the motor is running. Inching [or jogging] is understood as energizing a motor once or repeatedly for short periods to obtain small movements of the driven mechanism.)
AC-15	Electromagnets	Electromagnets for contactors, valves, solenoid actuators

**Squirrel-cage motors: starting, plugging, inching Ue = 230...460 VAC**

- ② Choose the graph for the utilization category selected. (a graph pertaining to most Utilization Categories can be found in each contactor section.)
- ③ Locate the Rated Operational Current (Ie) along the bottom of the chart and follow the graph lines up to the intersection of the appropriate contactor's life-load curve.
- ④ Read the estimated contact life along the vertical axis. ❷

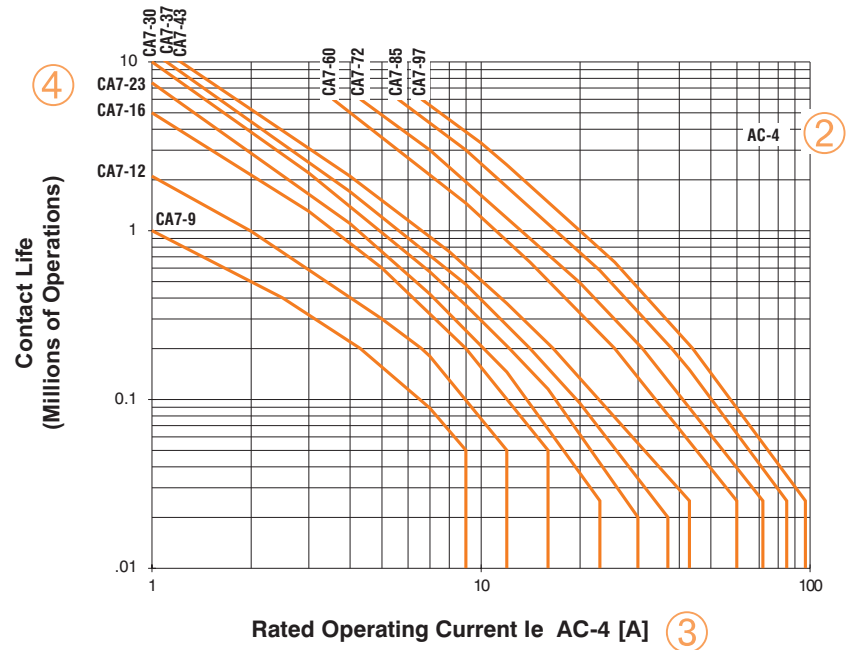

- ❶ A comprehensive list of Utilization Categories can be found in each contactor section, however, these are the primary categories used in most industrial motor applications.
- ❷ The life-load curves shown here are based on Sprecher+Schuh tests according to the requirements defined in IEC 60947-4-1. Since contact life in a given application is dependent on environmental conditions and duty cycle, actual application contact life may vary from that indicated by the curves shown here.



**Determining Contact Life**

To determine the contactor's estimated electrical life, follow these guidelines:

1. Identify the appropriate Utilization Category from Table A.
2. In the technical pages for each contactor size, choose the graph for the Utilization Category selected.
3. Locate the Rated Operational Current ( $I_e$ ) along the bottom of the chart and follow the graph lines up to the intersection of the appropriate contactor's life-load curve.
4. Read the estimated contact life along the vertical axis.

**Table A – IEC Special Utilization Categories, AC Ratings ❶**

	Cat-egory	Typical Applications	Conditions for testing electrical life						Ops.	Conditions for testing making and breaking capacity						Ops.	
			Make			Break				Make			Break				
			I/le	U/ue	cos	Ic/Ie	Ur/Ue	cos		I/le	U/ue	cos	Ic/Ie	U/ue	cos		
<b>CONTACTORS</b>	<b>AC-1</b>	Non-inductive or slightly inductive loads; resistance furnaces	All values	1	1	0.95	1	1	0.95	6000	1.5	1.05	0.8	1.5	1.05	0.8	50
	<b>AC-2</b>	Slip-ring motors: Starting, plugging	All values	2	1.05	0.65	2	1.05	0.65	6000	4	1.05	0.65	4	1.05	0.65	50
	<b>AC-3</b>	Slip-ring motors: Starting, switching off motors during running	$I_e \leq 17Amp$ $17Amp < I_e \leq 100Amp$ $I_e > 100Amp$	6	1	0.65	1	0.17	0.65	6000	10	1.1	0.65	8	1.1	0.65	50
			6	1	0.35	1	0.17	0.35	10		1.1	0.35	8	1.1	0.35		
			6	1	0.35	1	0.17	0.35	8 ❷		1.1	0.35	6 ❸	1.1	0.35		
	<b>AC-4</b>	Squirrel-cage motors: Starting, plugging, inching ❸	$I_e \leq 17Amp$ $17Amp < I_e \leq 100Amp$ $I_e > 100Amp$	6	1	0.65	6	1	0.65	6000	12	1.1	0.65	10	1.1	0.65	50
			6	1	0.35	6	1	0.35	12		1.1	0.35	10	1.1	0.35		
			6	1	0.35	6	1	0.35	10 ❹		1.1	0.35	8 ❷	1.1	0.35		
	<b>AC-5a</b>	Switching of electric discharge lamp control		2	1.05	0.45	2	1.05	0.45	6000	3	1.05	0.45	3	1.05	0.45	50
	<b>AC-5b</b>	Switching of incandescent lamps		1	1.05		1	1.05		6000	1.5	1.05		1.5	1.05		50
<b>AC-6a</b>	Switching of transformers									Rating derived from AC-3 rating (x 0.45)							
<b>AC-6b</b>	Switching of capacity banks									Depends on circuit conditions of application							
<b>CONTROL DEVICES</b>	<b>AC-12</b>	Control of resistive loads and solid state loads with isolation by opto couplers	All values	1	1	0.9	1	1	0.9	6050							
	<b>AC-13</b>	Control of solid state loads with transformer isolation		2	1	0.65	1	1	0.65	6050	10	1.1	0.65	1.1	1.1	0.65	10
	<b>AC-14</b>	Control of small electromagnetic loads	72 VA	6	1	0.3	1	1	0.3	6050	6	1.1	0.7	6	1.1	0.7	10
	<b>AC-15</b>	Control of electromagnetic loads	72 VA	10	1	0.3	1	1	0.3	6050	10	1.1	0.3	10	1.1	0.3	10
	<b>AC-20</b>	Connecting and disconnecting under no load conditions		No testing required													
<b>SWITCHES</b>	<b>AC-21</b>	Switching or resistive loads, including moderate overloads	All values	1	1	0.95	1	1	0.95	10000	1.5	1.05	0.95	1.5	1.05	0.95	5
	<b>AC-22</b>	Switching of mixed resistive & inductive loads, including moderate overloads	All values	1	1	0.8	1	1	0.8	10000	3	1.05	0.65	3	1.05	0.65	5
	<b>AC-23</b>	Switching of motor loads or other highly inductive loads	All values	1	1	0.65	1	1	0.65	10000	10	1.05	0.45	8	1.05	0.45	5

<b>Legend</b>	
<b>U<sub>e</sub></b>	Rated operational voltage
<b>U</b>	Voltage before make
<b>U<sub>r</sub></b>	Recovery voltage
<b>I<sub>e</sub></b>	Rated operational current
<b>I</b>	Making current
<b>I<sub>c</sub></b>	Breaking current
<b>L</b>	Inductance of test circuit
<b>R</b>	Resistance of test circuit

- ❶ Utilization categories and test conditions for AC & DC. For contactors according to IEC 158-1, starters according to IEC 292-1 ... 4 and control switches according to IEC 337-1 and IEC 337-1A.
- ❷ With a minimum value of 1000A for I or I<sub>c</sub>.
- ❸ With a minimum value of 800A for I<sub>c</sub>.
- ❹ With a minimum value of 1200A for I.
- ❺ Plugging is understood as stopping or reversing the motor rapidly by reversing the motor primary connections while the motor is running. Inching [or jogging] is understood as energizing a motor once or repeatedly for short periods to obtain small movements of the driven mechanism.

### Determining Contact Life

To determine the contactor's estimated electrical life, follow these guidelines:

1. Identify the appropriate Utilization Category from Table A.
2. In the technical pages for each contactor size, choose the graph for the Utilization Category selected.
3. Locate the Rated Operational Current ( $I_e$ ) along the bottom of the chart and follow the graph lines up to the intersection of the appropriate contactor's life-load curve.
4. Read the estimated contact life along the vertical axis.

**Table A – IEC Special Utilization Categories, DC Ratings ①**

Category	Typical Applications	Rated Current	Conditions for testing electrical life						Ops.	Conditions for testing making and breaking capacity						Ops.
			Make			Break				Make			Break			
			I/le	U/ue	cos	Ic/le	Ur/ue	cos		I/le	U/ue	cos	Ic/le	U/ue	cos	
<b>DC-1</b>	Non-inductive or slightly inductive loads, resistance furnaces	All Values	1	1	1	1	1	1		1.5 ②	1.1 ②	1 ②	1.5 ②	1.1 ②	1 ②	
<b>DC-2</b>	Shunt-motors: Starting, switching off motors during running	All Values	2.5	1	2	1	0.1	7.5		4	1.1	2.5	4	1.1	2.5	
<b>DC-3</b>	Shunt motors: Starting, plugging, inching	All Values	2.5	1	2	2.5	1	2		4	1.1	2.5	4	1.1	2.5	
<b>DC-4</b>	Series-motors: Starting, switching off motors during running	All Values	2.5	1	7.5	1	0.3	10		4	1.1	15	4	1.1	15	
<b>DC-5</b>	Series-motors: Starting, plugging, inching	All Values	2.5	1	7.5	2.5	1	7.5		4	1.1	15	4	1.1	15	
<b>DC-15</b>	Electromagnets for contactors, valves, solenoid actuators	All Values	1	1	6 x P ③	1	1	6 x P ③		1.1	1.1	6 x P ③	1.1	1.1	6 x P ③	

### CA7 Contactors for Elevator Duty Minimum Operational Life

Contactor	Cycles
CA7-9	500,000 ④⑤
CA7-12	
CA7-16	
CA7-23	
CA7-30	
CA7-37	
CA7-43	
CA7-55	
CA7-60	
CA7-72	
CA7-85	
CA7-97	

### CNX Special Purpose Contactor Minimum Operational Life in Resistive Applications

Contactor	Cycles
CNX-205	250,000 ④
CNX-205	
CNX-206	
CNX-207	
CNX-208	
CNX-209	100,000 ④
CNX-212	
CNX-218	

Legend	
<b>Ue</b>	Rated operational voltage
<b>U</b>	Voltage before make
<b>Ur</b>	Recovery voltage
<b>Ie</b>	Rated operational current
<b>I</b>	Making current
<b>Ic</b>	Breaking current
<b>L</b>	Inductance of test circuit
<b>R</b>	Resistance of test circuit

① Utilization categories and test conditions for AC & DC. For contactors according to IEC 158-1, starters according to IEC 292-1 ... 4 and control switches according to IEC 337-1 and IEC 337-1A.

② Only according to VDE.

③  $P = U_e \times I_e$  rated power [W]. The value "6 x P" has been derived from an empiric relationship which covers most magnetic loads for DC up to an upper limit of  $P = 50W$ .

④ Life data shown are the minimum test requirements per UL/CSA. Actual life in application may exceed these values.

⑤ Value pending on 55A and 97A contactors at time of this printing.

**Contactors Catalog Numbers**

Sprecher+Schuh employs a catalog number coding system for contactors (and many other devices) that follows a logical pattern, where every digit signifies a specific device attribute. Where indicated, the use of dashes (–) serves to separate device characteristics and should always be used when ordering. The following example illustrates all of the possible combina-

tions when specifying contactors and reversing contactors (open type only). See Section C for an explanation of the catalog number coding system for enclosed contactors and starters.



Configuration	
CA	Contactors
CAU	Reversing Contactors
CAN	NEMA Labeled Contactors
CA(V)L	Lighting Contactors
CNX	Special Purpose Contactors
CA_Y2	Elevator Wye-Delta

Contactors Series	
<u>Series CA8</u>	<u>Series CA9</u> ②
8-09(C)	9-116(-EI)
8-12(C)	9-146(-EI)
	9-190(-EI)
<u>Series CA7</u> ①	9-205(-EI)
7-9(E)	9-265(-EI)
7-12(E)	9-305(-EI)
7-16(E)	9-365(-EI)
7-23(E)	9-400-EI
7-30(E)	9-460-EI
7-37(E)	9-580-EI
7-40(E)	9-750-EI
7-43(E)	9-860-EI
7-55(E)	9-1060-EI
7-60(D)	9-1260-EI
7-72(D)	9-2050-EI
7-85(D)	9-2650-EI
7-90(D)	
7-97(D)	

Auxiliary Contacts	
-10	N.O. Auxiliary
-01	N.C. Auxiliary
-11	N.O. & N.C. Auxiliary
-02	2 N.C. Auxiliaries
-22	2 N.O. & 2 N.C. Aux.
-00	No Auxiliaries
<b>4-pole CA7 &amp; CA8 Contactors</b> ③	
-M40	4 N.O. Power Poles
-M31	3 N.O. Power Poles/ 1 N.C. Power Pole
-M22	2 N.O. Power Poles/ 2 N.C. Power Poles

Coil Code	
<u>AC</u>	<u>DC</u>
24Z	12E
120	24E, 24DD
220W	24W
277	36E
415	48E
480	110E, 110DD
600	220E
	<u>AC/DC</u>
	24W
	48W
	120W
	480W

**This illustration is for reference only.  
Turn to the appropriate page to determine  
specific catalog number.**

① (D) and (E) suffix designates DC contactors.  
 ② (-EI) suffix indicates electronic coil. Optional on CA9-116...365, standard on CA9-400...2650.  
 ③ On four pole contactors, this number designates main power pole configuration.



# Series CA8 Contactors and CAT8 Starters

## An ingenious miniature contactor and starter system

Sprecher + Schuh's CA8 Series of miniature contactors and starters provide an extremely compact and reliable method of controlling motors of 7.5 HP or less (@460V). The CA8 is an economical choice for applications where space is limited or where a minimal enclosure is desired.

### Small but rugged

Even though their contacts and coils are not replaceable, Sprecher + Schuh has subjected this series of contactors to monitored endurance tests that demonstrate their ruggedness. At full load, under 3-phase power, the contacts in the CA8 have an electrical life of 700,000 operations, while the AC magnet system has a mechanical life of 15,000,000 operations.



### The CAT8 Starter – Efficient and reliable

This miniature starter features the new CT8 Thermal Overload Relay. A complex current limiting calibration procedure performed after each unit ensures the consistent high quality of Sprecher + Schuh's thermal overload relay. Today's Class 10 T-frame design, like the CT8 Series, has been recognized by many motor manufacturers as the ideal type to assure optimum motor protection due to less use of copper and iron.

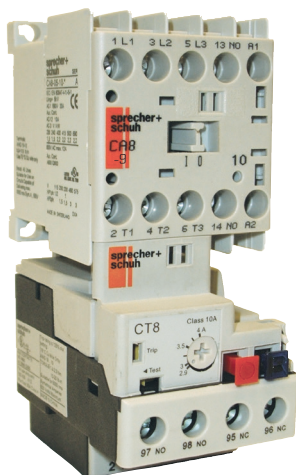

CAT8 starters feature the CT8 thermal overload.

### Accessories require no additional panel space

The entire CA8 System is logically engineered. Modular accessories like auxiliary contact blocks snap-on without increasing the CA8's original width of 45mm. Also, due to its horizontal switching movement, the basic contactor has the same low profile whether an AC or DC operating magnet is used. This permits the use of enclosures with shallow mounting depths. Once the CA8 is installed, all auxiliary contact blocks can be snapped-on or removed without

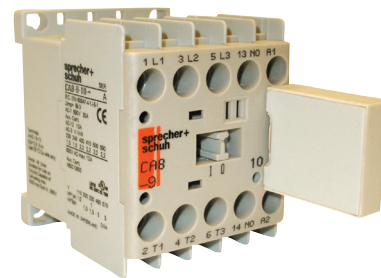

changing any existing power wiring. Other accessories include a snap-on RC Link (surge suppressor), mechanical interlocks and space saving adaptors for connecting auxiliary components.

### Effortless installation

Both the CA8 Contactor and the CAT8 Starter are DIN-rail mountable for instant installation and modification. Fittings are also included on the CA8 for base mounting. All terminals are clearly marked and shipped in the open position for installation with either manual or power screwdrivers.



45mm  
(≈1 7/16")



9A  
12A

**A** **Series CA8 Miniature Contactors, Starters, Overloads & Industrial Relays**

CA8 Contactors

- ✓ Rated 690V
- ✓ RoHs Compliant
- ✓ Conforming to U.S., Canadian, and IEC Standards
- ✓ Same Dimensions for AC and DC

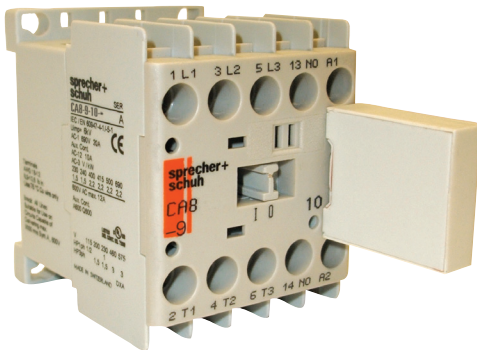
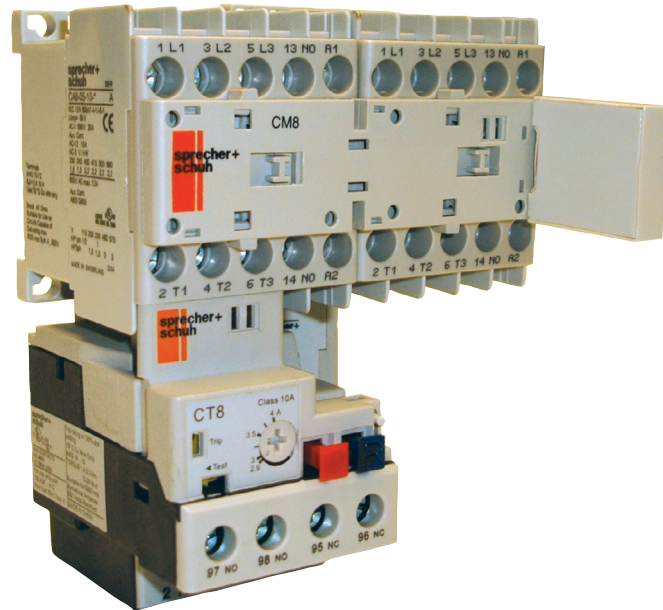

**Pluggable Surge Suppressor Modules**

- Suppressor modules are simply plugged on the front of the contactors, next to the auxiliary contact blocks.
- No wiring required.
- Fast and easy installation.

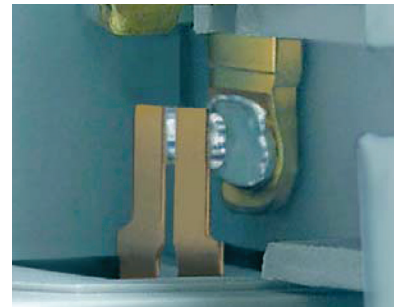

**Auxiliary Contact Reliability**

- Bifurcated, AgNi (silver/nickel) plated contacts for high contact reliability for 2mA/15V electronic signals.
- H-shaped self cleaning auxiliary contacts provide a 4-way current path ensure high contact reliability for low energy switching.

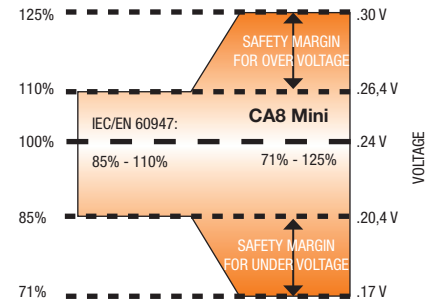
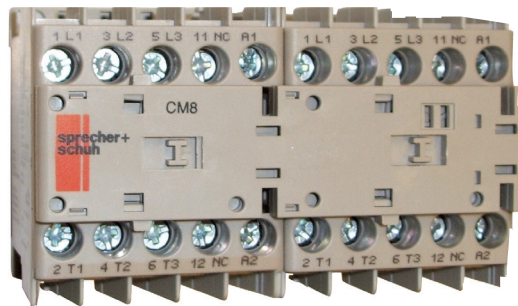

**High Performance AC & DC Coils**

- Wide range DC coils can provide reliability in case of over- and under-voltage, a common issue with battery-fed control power supply systems.
- The low coil consumption allows the contactors to be directly controlled via a PLC.
- Optional, integral factory-installed surge suppressor modules for AC and DC for limiting coil switching transients.

**MIRROR AND MECHANICALLY LINKED DESIGN**

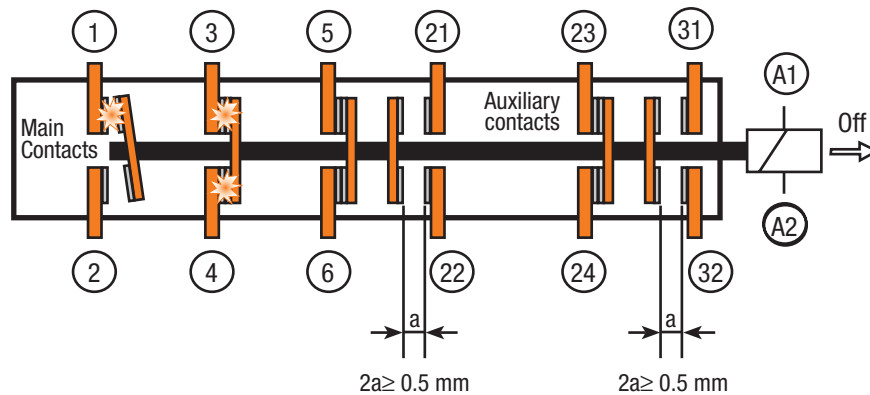

**All Around Safety**

- CA8: mechanically linked performance between main contacts and internal auxiliary contacts as per IEC 60947-5-1. This feature provides status feedback in the event of a contact weld.
- CA8/Auxiliary contacts: mechanically linked performance between main contacts and auxiliary contacts as per IEC 60947-5-1 for CA8 models with DC coils. Mechanically linked provides status feedback in the event of a contact weld. Mirror contact between main and auxiliary contacts as per IEC 60947-4-1 for CA8 models with AC coils. Mirror contacts prevent any unclear status indications if a N.O. power pole welds.

### Non-Reversing, Three Pole Contactors With AC Coil, Series CA8 (Open type only) ①⑦

$I_e$ [A]	Ratings for Switching AC Motors (AC2 / AC3 / AC4)										Auxiliary Contacts per Contactor		Open Type
	3 Ø kW (50 Hz)				UL/CSA HP (60 Hz)								
					1 Ø		3 Ø						
40°C													
AC-1	230V	400V 415V	500V	690V	115V	230V	200V	230V	460V	575V	NO	NC	Catalog Number
20	3	4	4	4	1/2	1-1/2	2	2	5	5	1	0	CA8-09-10-*
											0	1	CA8-09-01-*
20	3	5.5	5.5	5.5	3/4	2	3	3	7-1/2	7-1/2	1	0	CA8-12-10-*
											0	1	CA8-12-01-*

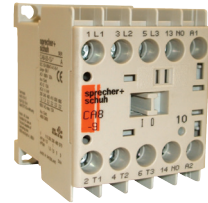

CA8-09-10 contactor

### Non-Reversing, Three Pole Contactors With DC Coil, Series CA8 (Open type only) ①②⑦

$I_e$ [A]	Ratings for Switching AC Motors (AC2 / AC3 / AC4)										Auxiliary Contacts per Contactor		Open Type
	3 Ø kW (50 Hz)				UL/CSA HP (60 Hz)								
					1 Ø		3 Ø						
40°C													
AC-1	230V	400V 415V	500V	690V	115V	230V	200V	230V	460V	575V	NO	NC	Catalog Number
20	3	4	4	4	1/2	1-1/2	2	2	5	5	1	0	CA8-09C-10-*
											0	1	CA8-09C-01-*
20	3	5.5	5.5	5.5	3/4	2	3	3	7-1/2	7-1/2	1	0	CA8-12C-10-*
											0	1	CA8-12C-01-*

#### AC Coil Codes ①③

AC Coil Code	Voltage Range	
	50 Hz	60 Hz
12	12V	12V
24Z	24V	24V
48Z	48V	48V
120	110V	120V
208	200V-220V	208V-220V
240	240V	240V
380 ⑤	Use Coil Code 400	
400 ⑤	400V	400V
480	440V	480V
575 ⑤	Use Coil Code 600	
600 ⑤	525V	600V

#### DC Coil Codes ①③

DC Coil Code	Voltage
12D	12V
24D	24V ④
110D	110V
125D	125V
220D	220V

#### Ordering Instructions

Specify Catalog Number	
Replace (*) with Coil Code	See Coil Codes on this page

- ① CA8 not available without coil. Coils and contacts not replaceable.
- ② Select Coil Code from DC Coil Code table only.
- ③ The coil codes shown are the most commonly stocked items. Contact your Sprecher + Schuh representative to determine if other voltages are available.
- ④ Integrated diode surge suppressor coils available. Order coil code **24DD**. Example: CA8-09C-10-**24D** becomes CA8-09C-10-**24DD**. Price additional applies.
- ⑤ The European Community has agreed that 400V is the nominal voltage in lieu of 380V. Use this code when 380V is required.
- ⑥ Use this code for 575V applications.
- ⑦ See page A27 regarding mechanically linked contacts and mirror contact performance.



### Non-Reversing, Four Pole Contactors With AC Coil, Series CA8 (Open type only) ①④⑧

$I_e$ [A]	Ratings for Switching AC Motors (AC2 / AC3)										Contact configuration main poles		Open Type
	3 Ø kW (50 Hz)				UL/CSA HP (60 Hz)								
	40°C					1 Ø		3 Ø				NO	NC
AC-1	230V	400V 415V	500V	690V	115V	230V	200V	230V	460V	575V			
20	3	4	4	4	1/2	1-1/2	2	2	5	5	4	0	CA8-09-M40-*
											3	1	CA8-09-M31-*
											2	2	CA8-09-M22-*
20	3	5.5	5.5	5.5	3/4	2	3	3	7-1/2	7-1/2	4	0	CA8-12-M40-*
											3	1	CA8-12-M31-*
											2	2	CA8-12-M22-*



CA8-09-M40 contactor

A  
CA8 Contactors

### Non-Reversing, Four Pole Contactors With DC Coil, Series CA8 (Open type only) ①②④⑧

$I_e$ [A]	Ratings for Switching AC Motors (AC2 / AC3)										Contact configuration main poles		Open Type
	3 Ø kW (50 Hz)				UL/CSA HP (60 Hz)								
	40°C					1 Ø		3 Ø				NO	NC
AC-1	230V	400V 415V	500V	690V	115V	230V	200V	230V	460V	575V			
20	3	4	4	4	1/2	1-1/2	2	2	5	5	4	0	CA8-09C-M40-*
											3	1	CA8-09C-M31-*
											2	2	CA8-09C-M22-*
20	3	5.5	5.5	5.5	3/4	2	3	3	7-1/2	7-1/2	4	0	CA8-12C-M40-*
											3	1	CA8-12C-M31-*
											2	2	CA8-12C-M22-*

#### AC Coil Codes ①③

AC Coil Code	Voltage Range	
	50 Hz	60 Hz
12	12V	12V
24Z	24V	24V
48Z	48V	48V
120	110V	120V
208	200V-220V	208V-220V
240	240V	240V
380 ⑥	Use Coil Code 400	
400 ⑥	400V	400V
480	440V	480V
575 ⑦	Use Coil Code 600	
600 ⑦	525V	600V

#### DC Coil Codes ①③

DC Coil Code	Voltage
12D	12V
24D	24V ④
110D	110V
125D	125V
220D	220V

#### Ordering Instructions

Specify Catalog Number	
Replace (*) with Coil Code	See Coil Codes on this page

- ① CA8 not available without coil. Coils and contacts not replaceable.
- ② Select Coil Code from DC Coil Code table only.
- ③ The coil codes shown are the most commonly stocked items. Contact your Sprecher + Schuh representative to determine if other voltages are available.
- ④ No auxiliary contacts provided in the base of a CA8. Add auxiliaries from page A21.
- ⑤ Integrated diode surge suppressor coils available. Order coil code **24DD**.  
Example: CA8-09C-10-**24D** becomes CA8-09C-10-**24DD**. Price addition applies.
- ⑥ The European Community has agreed that 400V is the nominal voltage in lieu of 380V. Use this code when 380V is required.
- ⑦ Use this code for 575V applications.
- ⑧ See page A27 regarding mechanically linked contacts and mirror contact performance.

### Reversing, Three Pole Contactors With AC Coil, Series CAU8 (Open type only) ①②③

I <sub>e</sub> [A]	Ratings for Switching AC Motors (AC2 / AC3 / AC4)										Auxiliary Contacts per Contactor		Open Type
	3 Ø kW (50 Hz)				UL/CSA HP (60 Hz)								
					1 Ø ⑦		3 Ø						
40°C													
AC-1	230V	400V 415V	500V	690V	115V	230V	200V	230V	460V	575V	NO	NC	<b>Catalog Number</b>
20	3	4	4	4	1/2	1-1/2	2	2	5	5	0	1	CAU8-09-02-*-LW
											2	1	CAU8-09-42-*-PW
20	3	5.5	5.5	5.5	3/4	2	3	3	7-1/2	7-1/2	0	1	CAU8-12-02-*-LW
											2	1	CAU8-12-42-*-PW



#### CAU8...LW Includes:

- Mechanical interlock (CM8)

#### CAU8...PW Includes:

- Mechanical and electrical interlock (CM8) ②
- Reversing power and control wiring (using Wiring Kit Cat.# CAUT8-PW)
- Top mount auxiliary contact block (Cat.# CA8-P20 on the -42- models)

### Reversing, Three Pole Contactors With DC Coil, Series CAU8 (Open type only) ①②③

I <sub>e</sub> [A]	Ratings for Switching AC Motors (AC2 / AC3 / AC4)										Auxiliary Contacts per Contactor		Open Type
	3 Ø kW (50 Hz)				UL/CSA HP (60 Hz)								
					1 Ø ⑦		3 Ø						
40°C													
AC-1	230V	400V 415V	500V	690V	115V	230V	200V	230V	460V	575V	NO	NC	<b>Catalog Number</b>
20	3	4	4	4	1/2	1-1/2	2	2	5	5	0	1	CAU8-09C-02-*-LW
											2	1	CAU8-09C-42-*-PW
20	3	5.5	5.5	5.5	3/4	2	3	3	7-1/2	7-1/2	0	1	CAU8-12C-02-*-LW
											2	1	CAU8-12C-42-*-PW

#### AC Coil Codes ①③

AC Coil Code	Voltage Range	
	50 Hz	60 Hz
12	12V	12V
24Z	24V	24V
48Z	48V	48V
120	110V	120V
208	200V-220V	208V-220V
240	240V	240V
380 ⑥	Use Coil Code 400	
400 ⑥	400V	400V
480	440V	480V
575 ⑥	Use Coil Code 600	
600 ⑥	525V	600V

#### DC Coil Codes ①③

DC Coil Code	Voltage
12D	12V
24D	24V ④
110D	110V
125D	125V
220D	220V

#### Ordering Instructions

Specify Catalog Number	
Replace (*) with Coil Code	<b>See Coil Codes on this page</b>

- ① CA8 not available without coil. Coils and contacts not replaceable.
- ② Internal NC contacts on each contactor are used for electrical interlocking.
- ③ The coil codes shown are the most commonly stocked items. Contact your Sprecher + Schuh representative to determine if other voltages are available.
- ④ Integrated diode surge suppressor coils available. Order coil code **24DD**. Example: CAU8-09C-02-**24D** becomes CAU8-09C-02-**24DD**. Price addition applies.
- ⑤ The European Community has agreed that 400V is the nominal voltage in lieu of 380V. Use this code when 380V is required.
- ⑥ Use this code for 575V applications.
- ⑦ Does not apply to CAU8...-PW.
- ⑧ See page A27 regarding mechanically linked contacts and mirror contact performance.

### Non-Reversing, Three Pole Starters With AC Coil, Series CAT8 (Open type only) ①⑦

$I_e$ [A]	Ratings for Switching AC Motors (AC2 / AC3 / AC4)										Auxiliary Contacts per Contactor		Open Type
	3 Ø kW (50 Hz)				UL/CSA HP (60 Hz)								
					1 Ø		3 Ø						
40°C													
AC-1	230V	400V 415V	500V	690V	115V	230V	200V	230V	460V	575V	NO	NC	<b>Catalog Number</b>
20	3	4	4	4	1/2	1-1/2	2	2	5	5	1	0	CAT8-09-10-*-◆
											0	1	CAT8-09-01-*-◆
20	3	5.5	5.5	5.5	3/4	2	3	3	7-1/2	7-1/2	1	0	CAT8-12-10-*-◆
											0	1	CAT8-12-01-*-◆

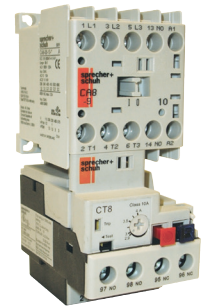

### Non-Reversing, Three Pole Starters With DC Coil, Series CAT8 (Open type only) ①②⑦

$I_e$ [A]	Ratings for Switching AC Motors (AC2 / AC3 / AC4)										Auxiliary Contacts per Contactor		Open Type
	3 Ø kW (50 Hz)				UL/CSA HP (60 Hz)								
					1 Ø		3 Ø						
40°C													
AC-1	230V	400V 415V	500V	690V	115V	230V	200V	230V	460V	575V	NO	NC	<b>Catalog Number</b>
20	3	4	4	4	1/2	1-1/2	2	2	5	5	1	0	CAT8-09C-10-*-◆
											0	1	CAT8-09C-01-*-◆
20	3	5.5	5.5	5.5	3/4	2	3	3	7-1/2	7-1/2	1	0	CAT8-12C-10-*-◆
											0	1	CAT8-12C-01-*-◆

Representative model of a CAT8-09... starter with the CT8 bimetallic overload relay

**NOTE:** CAT8 starters are priced to include Sprecher + Schuh's economical CT8 bimetallic overload relay. See A23 for selection.

### AC Coil Codes ①③

AC Coil Code	Voltage Range	
	50 Hz	60 Hz
12	12V	12V
24Z	24V	24V
48Z	48V	48V
120	110V	120V
208	200V-220V	208V-220V
240	240V	240V
380 ⑤	Use Coil Code 400	
400 ⑤	400V	400V
480	440V	480V
575 ⑥	Use Coil Code 600	
600 ⑥	525V	600V

### DC Coil Codes ①③

DC Coil Code	Voltage
12D	12V
24D	24V ④
110D	110V
125D	125V
220D	220V

### Ordering Instructions

Specify Catalog Number	
Replace (*) with Coil Code	<b>Coil Codes on this page O/L Relay Code on A23</b>
Replace (◆) with O/L Relay Code	

- ① CA8 not available without coil. Coils and contacts not replaceable.
- ② Select Coil Code from DC Coil Code table only.
- ③ The coil codes shown are the most commonly stocked items. Contact your Sprecher + Schuh representative to determine if other voltages are available.
- ④ Integrated diode surge suppressor coils available. Order coil code **24DD**. Example: CAT8-09C-10-**24D** becomes CAT8-09C-10-**24DD**. Price addition applies.
- ⑤ The European Community has agreed that 400V is the nominal voltage in lieu of 380V. Use this code when 380V is required.
- ⑥ Use this code for 575V applications.
- ⑦ See page A27 regarding mechanically linked contacts and mirror contact performance.

### Reversing, Three Pole Starters With AC Coil, Series CAUT8 (Open type only) ①②⑦

I <sub>e</sub> [A]	Ratings for Switching AC Motors (AC2 / AC3 / AC4)										Auxiliary Contacts per Contactor		Open Type
	3 Ø kW (50 Hz)				UL/CSA HP (60 Hz)								
					1 Ø		3 Ø						
40°C													
AC-1	230V	400V 415V	500V	690V	115V	230V	200V	230V	460V	575V	NO	NC	Catalog Number
20	3	4	4	4	~	~	2	2	5	5	0	1	<b>CAUT8-09-02-*-◆-LW</b>
											2	1	<b>CAUT8-09-42-*-◆-PW</b>
20	3	5.5	5.5	5.5	~	~	3	3	7-1/2	7-1/2	0	1	<b>CAUT8-12-02-*-◆-LW</b>
											2	1	<b>CAUT8-12-42-*-◆-PW</b>



#### CAUT8...LW Includes:

- Mechanical interlock
- Utilizes CT8 bimetallic overload relay. Select code from page A23.

#### CAUT8...PW Includes:

- Mechanical and electrical interlock ②
- Utilizes CT8 bimetallic overload relay. Select code from page A23.
- Reversing power and control wiring (using Wiring Kit Cat.# CAUT8-PW)
- Top mount auxiliary contact block (Cat.# CA8-P20 on the -42- models)

### Reversing, Three Pole Starters With DC Coil, Series CAUT8 (Open type only) ①②⑦

I <sub>e</sub> [A]	Ratings for Switching AC Motors (AC2 / AC3 / AC4)										Auxiliary Contacts per Contactor		Open Type
	3 Ø kW (50 Hz)				UL/CSA HP (60 Hz)								
					1 Ø		3 Ø						
40°C													
AC-1	230V	400V 415V	500V	690V	115V	230V	200V	230V	460V	575V	NO	NC	Catalog Number
20	3	4	4	4	~	~	2	2	5	5	0	1	<b>CAUT8-09C-02-*-◆-LW</b>
											2	1	<b>CAUT8-09C-42-*-◆-PW</b>
20	3	5.5	5.5	5.5	~	~	3	3	7-1/2	7-1/2	0	1	<b>CAUT8-12C-02-*-◆-LW</b>
											2	1	<b>CAUT8-12C-42-*-◆-PW</b>

### AC Coil Codes ①③

AC Coil Code	Voltage Range	
	50 Hz	60 Hz
12	12V	12V
24Z	24V	24V
48Z	48V	48V
120	110V	120V
208	200V-220V	208V-220V
240	240V	240V
380 ⑤	Use Coil Code 400	
400 ⑤	400V	400V
480	440V	480V
575 ⑤	Use Coil Code 600	
600 ⑤	525V	600V

### DC Coil Codes ①③











DC Coil Code	Voltage
	12D
24D	24V ④
110D	110V
125D	125V
220D	220V



### Ordering Instructions

Specify Catalog Number	
Replace (*) with Coil Code	Coil Codes on this page O/L Relay Code on A23
Replace (◆) with O/L Relay Code	

- ① CA8 not available without coil. Coils and contacts not replaceable.
- ② NC contacts on each contactor are used for electrical interlocking.
- ③ The coil codes shown are the most commonly stocked items. Contact your Sprecher + Schuh representative to determine if other voltages are available.
- ④ Integrated diode surge suppressor coils available. Order coil code **24DD**. Example: CAUT8-09C-02-**24D** becomes CAUT8-09C-02-**24DD**. Price addition applies.
- ⑤ The European Community has agreed that 400V is the nominal voltage in lieu of 380V. Use this code when 380V is required.
- ⑥ Use this code for 575V applications.
- ⑦ See page A27 regarding mechanically linked contacts and mirror contact performance.

**Auxiliary Contact Blocks (2 & 4 Pole) ①②**

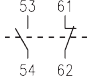
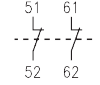
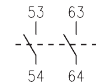
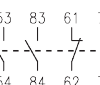
Auxiliary Contact Blocks	NO	NC	Contact Arrangement	Catalog No.
 2-Pole  Typical auxiliary contact block	1	1		CA8-P11
	0	2		CA8-P02
	2	0		CA8-P20
	2	2		CA8-P22
 4-Pole	3	1		CA8-P31
	1	3		CA8-P13
	0	4		CA8-P04
	4	0		CA8-P40

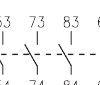
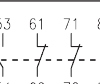
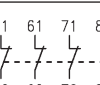
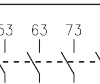



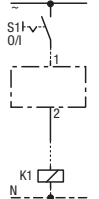

Auxiliary Contact Blocks	NO	NC	Contact Arrangement	Catalog No.
 2-Pole  Typical auxiliary contact block	1	1		CS8-P11E
	0	2		CS8-P02E
	2	0		CS8-P20E
	2	2		CS8-P22Z
 4-Pole	3	1		CS8-P31Z
	1	3		CS8-P13E
	0	4		CS8-P04E
	4	0		CS8-P40E

**Electronic Timer**

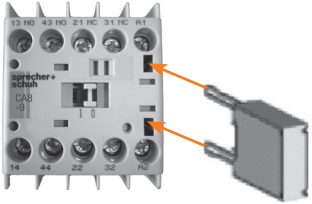
Module	Description	Function	Connection Diagrams	For use with...	Pkg Qty	Catalog Number
	<b>Solid-State Timing Element –</b> • 110...250V AC or DC • Includes 35mm Hat Rail adapter	On-Delay 0.1...3 s  On-Delay 1...30 s		CA8/CS8 all	10	CRZE8-3S CRZE8-30S

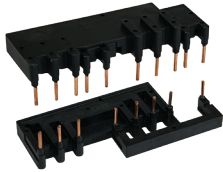
① Auxiliary contacts mirror contact performance per IEC 60947-4-1. Contacts are bifurcated (H-bridge) with a minimum rating of 2mA @ 15V.  
 ② See page A27 regarding mechanically linked contacts and mirror contact performance.

### Miscellaneous Accessories

Accessory	Description	Catalog Number
	<p><b>Surge Suppressor CR__8</b> - for limiting voltage spikes when switching off coil. Coil itself provides sufficient limitation at voltages over 240V.</p> <p>RC Link (Type CRC8...) for AC Control            24-48VAC            110-280VAC            380-480VAC</p>	<p><b>CRC8-50</b>  <b>CRC8-280</b>  <b>CRC8-480</b></p>
	<p>Diode Link (Type CRD8...) for DC Control ❶            12-250VDC (diode)</p>	<p><b>CRD8-250</b></p>
	<p>Varistor Link (Type CRV8...) for AC/DC Control            12-55VAC/12-77VDC            56-136VAC/78-180VDC            137-277VAC/181-250VDC</p>	<p><b>CRV8-55</b>  <b>CRV8-136</b>  <b>CRV8-277</b></p>
	<p><b>Mechanical Interlock Kit -</b>            For interlocking of two adjacent contactor            – without additional space requirement in width            – attachable from the front (top) of contactor            – optional auxiliary contact blocks can be mounted on the top (does not interfere with mounting CR__8)</p>	<p><b>CM8</b></p>
	<p><b>Wiring Kit -</b>            For connecting line, load and control wiring of a CAU8 reversing contactor.            – works with CT8 Overloads</p>	<p><b>CAUT8-PW</b></p>
	<p><b>Connection Modules -</b>            For KTA7 motor circuit controller with a CA8 contactor.</p>	<p><b>KT7-25S-PEK12</b></p>
	<p><b>Feeder Terminal for Compact Bus Bars -</b>            Supply of compact bus bars.            For use with CA8-09 and CA8-12            34 Amps max.</p>	<p><b>CA8-WT</b></p>
	<p><b>Three-Phase Compact Bus Bars -</b>            For use with CA8-09 and CA8-12 Contactors with 45 mm spacing. (3 connections)            34 Amps max.</p>	<p><b>CA8-W453</b></p>
	<p><b>Three-Phase Compact Bus Bars -</b>            For use with CA8-09 and CA8-12 Contactors with 45 mm spacing. (4 connections)            34 Amps max.</p>	<p><b>CA8-W454</b></p>

❶ CA8 contactors with 24 VDC coils can be special ordered with integrated diodes (built-in) rather than applying CRD8 to the coil terminals.

**CAT8 Starters with CT8 Thermal Overload Relay**

For use with contactor....	Amp Range	Overload Relay Code (◆)	Catalog Number (of Overload Relay used)
<b>1 or 3-Phase, Auto/Manual, Class 10</b>			
CA8-09	0.10...0.16	<b>8A16</b>	<b>CT8-A16</b>
	0.16...0.25	<b>8A25</b>	<b>CT8-A25</b>
	0.25...0.4	<b>8A40</b>	<b>CT8-A40</b>
	0.35...0.5	<b>8A50</b>	<b>CT8-A50</b>
	0.45...0.63	<b>8A63</b>	<b>CT8-A63</b>
	0.55...0.8	<b>8A80</b>	<b>CT8-A80</b>
	0.75...1.0	<b>8B10</b>	<b>CT8-B10</b>
	0.90...1.3	<b>8B13</b>	<b>CT8-B13</b>
	1.10...1.6	<b>8B16</b>	<b>CT8-B16</b>
	1.4...2.0	<b>8B20</b>	<b>CT8-B20</b>
	1.8...2.5	<b>8B25</b>	<b>CT8-B25</b>
	2.3...3.2	<b>8B32</b>	<b>CT8-B32</b>
	2.9...4.0	<b>8B40</b>	<b>CT8-B40</b>
	3.5...4.8	<b>8B48</b>	<b>CT8-B48</b>
4.5...6.3	<b>8B63</b>	<b>CT8-B63</b>	
5.5...7.5	<b>8B75</b>	<b>CT8-B75</b>	
CA8-09 or 12	7.2...10	<b>8C10</b>	<b>CT8-C10</b>
CA8-12	9.0...12.5	<b>8C12</b>	<b>CT8-C12</b>

**Obsolete Contactors Cross Reference, Series CA4 to Series CA8 (Open Type Only)**

$I_e$ [A]		Ratings for Switching AC Motors (AC2 / AC3 / AC4)									Auxiliary Contacts per Contactor		Series CA4 Obsolete Catalog Number	Series CA8 Replacement Catalog Number
		kW (50 Hz)			UL/CSA HP (60 Hz)									
		230V	400V 415V	500V	1 Ø		3 Ø							
AC-3	AC-1				115V	230V	200V	230V	460V	575V	NO	NC		
9	20	3	4	4	1/2	1-1/2	2	2	5	5	1	0	<b>CA4-9-10</b>	
											0	1	<b>CA4-9-01</b>	
~	20	3	4	4	1/2	1-1/2	2	2	5	5	1	0		<b>CA8-09-10</b>
											0	1		<b>CA8-09-01</b>
12	20	3	5.5	4	1/2	2	3	3	7-1/2	10	1	0	<b>CA4-12-10</b>	
											0	1	<b>CA4-12-01</b>	
~	20	3	5.5	5.5	3/4	2	3	3	7-1/2	7-1/2	1	0		<b>CA8-12-10</b>
											0	1		<b>CA8-12-01</b>

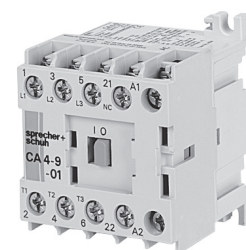

CA4-9-10 Contactor

### Technical Information

		CA8-09	CA8-12			CA8-09	CA8-12				
<b>Rated Insulation Voltage <math>U_i</math></b> to IEC947-1	[V]	690V		<b>Wye-Delta (Star Delta)</b> 50 Hz	≤230V	[A]	20	20			
	[V]	600V			≤240V	[A]	20	20			
<b>Rated Impulse Voltage Withstand <math>U_{imp}</math></b>	[kV]	6		400V	[A]	15.5	15.5				
				415V	[A]	15.5	15.5				
<b>Rated Voltage <math>U_e</math>-Main Contacts</b>				500V	[A]	12.4	12.4				
				690V	[A]	8.9	8.9				
AC 50/60Hz	[V]	230, 240, 400, 415, 500, 690		230V	[kW]	5.5	5.5				
				240V	[kW]	5.5	5.5				
DC	[V]	24, 48, 110, 220, 440		400V	[kW]	7.5	10				
				415V	[kW]	7.5	11				
<b>Operating Frequency for AC Loads</b>	[Hz]	50/60Hz		500V	[kW]	7.5	7.5				
				690V	[kW]	7.5	7.5				
<b>Switching Motor Loads</b>											
<b>Standard IEC Ratings</b>											
<b>AC-2, AC-3, AC-4</b> DOL & Reversing 50Hz@60° C	230V	[A]	11.3	11.3	<b>AC-1 Load, 3Ø Switching</b> Ambient Temperature 40° C	$I_e$	[A]	20	20		
	240V	[A]	11.3	11.3		230V	[kW]	8	8		
	400V	[A]	8.5	11.5		240V	[kW]	8.3	8.3		
	415V	[A]	8.5	11.5		400V	[kW]	14	14		
	500V	[A]	6.8	9.2		415V	[kW]	14	14		
	690V	[A]	4.9	6.7		500V	[kW]	17	17		
	230V	[kW]	3	3		690V	[kW]	24	24		
	240V	[kW]	3	3		Ambient Temperature 60° C	$I_e$	[A]	16	16	
	400V	[kW]	4	5.5			230V	[kW]	6.4	6.4	
	415V	[kW]	4	5.5			240V	[kW]	6.7	6.7	
500V	[kW]	4	5.5	400V	[kW]		11	11			
690V	[kW]	4	5.5	415V	[kW]		12	12			
				500V	[kW]		14	14			
				690V	[kW]		19	19			
				<b>Continuous Current (UL/CSA)</b>							
<b>UL/CSA</b> DOL & Reversing 60Hz	1Ø	115V	[A]	9.8	13.8	General Purpose Rating (40° C)	Open	[A]	15	18	
		230V	[A]	10	12		Enclosed	[A]	15	18	
		115V	[HP]	0.5	0.75	<b>Lighting Loads</b>	Gas Dischrg.Lamps-AC-5a, 220...240VAC (40°C)	Open	[A]	18	18
		230V	[HP]	1.5	2			Enclosed	[A]	14.5	14.5
		200V	[A]	7.8	11		Single compensated	10kA	[µF]	750	750
		230V	[A]	6.8	9.6		Max. capacitance at	20kA	[µF]	400	400
		460 V	[A]	7.6	11		prospective short circuit	50kA	[µF]	~	~
		3Ø	575 V	[A]	6.1		9	current available at the	contactor		
			200 V	[HP]	2		3	Incandescent Lamps			
			230 V	[HP]	2		3	- AC-5b			
		460 V	[HP]	5	7.5	Electrical endurance~100,000 operations					
		575 V	[HP]	5	7.5	230/240V					
						[A]	9.0	9.0			
<b>Maximum Operating Rate</b> At 9A for AC3; 20A for AC2/4 Starting time $t_A = 0.25s$	AC2	[ops/hour]	300	300							
	AC3	[ops/hour]	600	600							
	AC4	[ops/hour]	300	300							
	<b>AC4 (200,000 Op. Cycles)</b> 50Hz	230V	[A]	3.9	3.9						
		240V	[A]	3.9	3.9						
400V		[A]	3.6	3.6							
415V		[A]	3.6	3.6							
500V		[A]	3.2	3.2							
	230V	[kW]	0.75	0.75							
	240V	[kW]	0.75	0.75							
	400V	[kW]	1.5	1.5							
	415V	[kW]	1.5	1.5							
	500V	[kW]	1.5	1.5							
<b>Max. Operating Rate</b>		[ops/hour]	250	250							



## Electrical Data

			CA8-09	CA8-12
<b>Switching power transformers AC-6a (50Hz)</b>				
Inrush	= $\eta$			
Rated transformer current	$\eta = 30$			
$\eta = 30$	≤230V	[A]	5.4	5.4
	≤240V	[A]	5.4	5.4
	≤400V	[A]	4.1	5.4
	≤415V	[A]	4.1	5.4
	≤500V	[A]	3.2	3.2
	230VAC	[kVA]	2	2
	240VAC	[kVA]	2	2
	400VAC	[kVA]	2.8	3.4
	415VAC	[kVA]	2.8	3.4
	500VAC	[kVA]	2.8	3.4
	690VAC	[kVA]	4	5
<b>DC Ratings</b>				
<b>DC-1 Rating at 60°C</b>				
1 Pole	24VDC	[A]	9	9
	48/60VDC	[A]	6/1.5	6/1.5
	110VDC	[A]	1	1
	220VDC	[A]	0.3	0.3
	440VDC	[A]	0.1	0.1
2 Pole in Series	24VDC	[A]	9	9
	48/60VDC	[A]	8	8
	110VDC	[A]	6	6
	220VDC	[A]	1.2	1.2
	440VDC	[A]	0.3	0.3
3 Pole in Series	24VDC	[A]	9	9
	48VDC	[A]	9	9
	110VDC	[A]	9	9
	220VDC	[A]	4	4
	440VDC	[A]	0.6	0.6
<b>Shunt-wound Motors</b>				
Starting, reverse current braking, reversing stepping DC-3, 60°C				
	24V	[A]	9	9
3 Poles in series	48/60V	[A]	6	6
	110V	[A]	3	3
	220V	[A]	1.2	1.2
	440V	[A]	0.2	0.2
<b>Series-wound Motors</b>				
Starting, reverse current braking, reversing stepping DC-5, 60°C				
	24V	[A]	9	9
3 poles in series	48/60V	[A]	3	3
	110V	[A]	1	1
	220V	[A]	0.1	0.1
	440V	[A]	~	~
<b>Short Time Withstand-<math>I_{CW}</math>, 60°C</b>				
	10s	[A]	96	96
<b>Short Circuit Coordination</b> (Max. Fuse or Circuit Breaker Rating)				
50 kA Max. DIN fuse gG per IEC 60947-4-1 (Contactor and Fuse only)				
Available Fault Current				
Type 1 Coordination (690V)	max.	[A]	35	35
Type 2 Coordination (690V)	max.	[A]	20	20
<b>UL Info</b>				
Per UL 508 and CSA 22.2 No. 14 (contactor and fuses or circuit breaker only)				
<b>UL Class K5 and RK5 Fuses</b>				
5 kA Available Fault Current				
UL Listed Combination (600V)		[A]	40	40
<b>UL Class CC and CSA HRCI-MISC Fuses</b>				
50 kA Available Fault Current				
UL Listed Combination (600V)		[A]	30	30
<b>UL Class J and CSA HRCI-J Fuses</b>				
50 kA Available Fault Current				
UL Listed Combination (600V)		[A]	30	30
<b>Resistance and Watt Loss <math>I_g</math> AC3</b>				
Resistance per power pole				
		[mΩ]	2.2	2.2
Watt Loss - 3 power poles @400V				
		[W]	0.9	0.9
Coil and AC @400V, warm				
		[W]	2.7	2.7
3 power poles DC, warm				
		[W]	3.5	3.5
<b>Coil Data</b>				
			CA8-09	CA8-12
<b>Voltage Range</b>				
AC: 50Hz, 60Hz, 50/60 Hz	Pickup	[x $U_S$ ]	0.85...1.1	
	Dropout	[x $U_S$ ]	0.2...0.75	
DC	Pickup	[x $U_S$ ]	0.80...1.1	
			9, 12, 24, 110V DC: 0.7...1.25	
	Dropout	[x $U_S$ ]	0.1...0.75	
<b>Coil Consumption</b>				
AC: 50Hz, 60Hz, 50/60 Hz	Pickup	[VA]	35	
	Hold-in	[VA/W]	5/1.8	
DC	Pickup	[W]	cold 3.0, warm 2.6	
	Hold-in	[W]	cold 3.0, warm 2.6	
<b>Operating Times</b>				
AC: 50Hz, 60Hz, 50/60 Hz	Pickup	[ms]	15...40	
	Dropout	[ms]	15...33	
with RC Suppressor	Dropout	[ms]	15...28	
DC	Pickup	[ms]	18...40	
	Dropout	[ms]	6...12	
with Integ. Suppression	Dropout	[ms]	8...12	
with external diode Suppression	Dropout	[ms]	35...50	
Minimal changeover time for reversing		[ms]	>50	

① UL listed combination.

### Mechanical Data

			CA8-09	CA8-12
<b>Service Life</b>				
Mechanical	AC/DC	[Mil.Op.]		15
Electrical	AC-3(400V)	[Mil.Op.]		0.7
Reversing combination, mechanical, electrical		[Mil.Op.]		0.7
<b>Shipping Weights</b>				
AC-CA8	[kg]			0.16
	[Lbs]			0.35
AC-CAU8	[kg]			0.35
	[Lbs]			0.77
DC-CA8	[kg]			0.20
	[Lbs]			0.44
DC-CAU8	[kg]			0.43
	[Lbs]			0.91

### Terminations - Screw Type Terminals

Main contacts and Auxiliary contacts



Terminal Type	Combination Screw Head: Cross, Slotted, Pozidrive		
Fine stranded w/ ferrule	1 wire	[mm <sup>2</sup> ]	0.75...2.5
	2 wires	[mm <sup>2</sup> ]	0.75...2.5
Solid or coarse stranded	1 wire	[mm <sup>2</sup> ]	1...4
	2 wires	[mm <sup>2</sup> ]	1...2.5 + 1...4
Torque Requirement		[Nm]	1.2
		[Lb-in]	10.6

### Environmental and General Specifications

#### Ambient Temperature ②

Storage	-55...+80° C (-67...176° F)
Operation	-25...+60° C (-13...140° F) (40° C per UL)
Conditioned 15% current reduction after AC-1 at >60° C	-25...+70° C (-13...158° F)

**Altitude at installed site** 2000 meters above sea level per IEC 60947-4

#### Resistance to Corrosion / Humidity

Damp-alternating climate: cyclic to IEC 68-2, 56 cycles.  
Dry Heat: IEC 68-2, +100°C (212°F), relative humidity <50%, 7 days.  
Damp tropical: IEC 68-2, +40°C (104°F), relative humidity <92%, 56 days.

**Shock Resistance** IEC 68-2/EN 60068

**Vibration Resistance** IEC 68-2/EN 60068

**Operating Position** Refer to Dimension Page A29

**Standards** IEC/EN 60947-1, -4-1, -5-1, -5-4; UL 508; CSA 22.2. No. 14

**Approvals** CE, cULus, CCC

### High Fault Short Circuit Ratings per UL508 and CSA 22.2 No.14

Overload Cat. No.	Contactor Cat. No.	Max. starter FLC (A)	Fuse Ratings			UL Listed Circuit Breaker Ratings ①			Group Installation ①	
			Max. available fault current (kA)	Max. voltage (V)	UL Class J, CC, CSA HRCI-J fuse max. (A)	Short Circuit Rating (kA)	Max. voltage (V)	Max. CB Rating (A)	Max. CB rating (A)	
CT8	A16...A40	CA8-09	10	50	600	1	5	600	15	30
	A50...A63					2				
	A80...B10					3				
	B13					4				
	B16					5				
	B20					8				
	B25					10				
	B32					12				
	B40...B48					15				
	B63					20				
	B75					25				
	C10					35				
C12	CA8-09...12									
	CA8-12	13.8								

① Group installation ratings can be applied when used with CA8 Compact Bus Bars (see A22) in a minimum 1,152 cu. in. enclosure with two latches.

② Ambient is the temperature outside the enclosure.

### Auxiliary Contacts

		Built-in Auxiliary Contacts									Add-on Auxiliary Contacts								
<b>Current Switching</b>																			
AC-12 $I_{th}$	at 40°C [A]	10									10								
	at 60°C [A]	6									6								
AC-15, switching electromagnetic loads at:	[V]	24	120	240	400	480	500	600	690		24	120	240	400	480	500	600	690	
	[A]	6	6	3	1.8	1.5	1.4	1.2	1		3	3	2	1.2	1	1	0.6	0.6	
DC-13, switching DC electromagnets at:	[V]	24	48	110	125	220	250	400	440	600	24	48	110	125	220	250	400	440	600
	[A]	2.8	1.2	0.55	0.55	0.27	0.27	0.15	0.15	0.10	2.3	1	0.55	0.55	0.27	0.27	0.15	0.15	0.10
DC-12, L/R < 1 ms resistive loads at:	[V]	24	48	110	125	220	250	400	440										
	[A]	6	4	0.6	0.6	0.2	0.2	0.08	0.08										
DC-14, L/R < 15 ms inductive loads with economy resistor in series at:	[V]	24	48	110	125	220	250	400	440										
	[A]	4	2.5	0.4	0.4	0.12	0.12	0.05	0.05										
<b>Low Level Signal Switching</b>																			
Contact design		X-stamped									H-bridge, bi-furcated								
Minimum switching recommendation	[V]	17V									15V								
	[mA]	10mA									2mA								
<b>Short-Circuit Protection - gG Fuse</b>																			
Type 2 Coordination	[A]	10									10								
<b>Load carrying capacity per UL/CSA</b>																			
Rated Voltage	AC [V]	600 max.									600 max.								
Continuous Rating	40°C [A]	10 general purpose									10 general purpose								
Switching Capacity	AC	Heavy pilot duty (A600)									Heavy pilot duty (B600)								
Rated Voltage	DC [V]	600 max.									600 max.								
Switching Capacity	DC	Standard pilot duty (Q600)									Standard pilot duty (Q600)								
Mechanically Linked Contacts IEC 60947-5-1, Annex L		Yes									No								
Mirror Contacts IEC 60947-4, Annex F		Yes									Yes								

### Contact Ratings (Per NEMA/UL A600, B600 & Q600)

Standard	Circuit Voltage	Make (Amps/VA)	Break (Amps/VA)	Continuous Amps
A600	120AC 240AC 480AC 600AC	60A/7200VA 30A/7200VA 15A/7200VA 12A/7200VA	60A/720VA 30A/720VA 15A/720VA 12A/720VA	10
B600	120AC 240AC 480AC 600AC	30A/3600VA 15A/3600VA 7.5A/3600VA 6A/3600VA	3.0A/360VA 1.5A/360VA 0.75A/360VA 0.60A/360VA	10
Q600	125DC 250DC 301-600DC	0.55/69VA 0.27/69VA 0.1A/69VA	0.55/69VA 0.27/69VA 0.1A/69VA	2.5

### Mechanically Linked Contacts and Mirror Contact Performance

Type	Coil	Add-on Auxiliary Contact	Conforms to IEC	Status
CA8	AC or DC	None	60947-5-1	Mechanically linked within the base contactor
	DC	Yes	60947-5-1	Mechanically linked within the base contactor and with add-on auxiliary contacts
	AC	Yes	60947-4-1	Mechanically linked within the base contactor and mirror contact performance with add-on auxiliary contacts

#### Definitions

- Mechanically linked contacts (IEC 60947-5-1 Annex L):
  - N.C. Auxiliary Contact will not re-close if a N.O. power pole welds.
  - N.O. Power Pole or Auxiliary Contact will not close if N.C. contact welds.
  - The term "Positive Guided" contacts is the same as mechanically linked.
- Mirror Contacts (IEC 60947-4-1 Annex F): N.C. Auxiliary Contact will not be in closed position if a N.O. power pole welds.

**Life-Load Curves**

- Locate the Rated Operational Current ( $I_e$ ) along the bottom of the chart and follow the graph lines up to the intersection of the appropriate contactor's life-load curve.
- Read the estimated contact life along the vertical axis.

Instructions on *How to* read Life Curves can be found on page A8

**AC-1, AC3**

AC-1 Non- or slightly inductive loads, resistance furnaces;  
AC-3 Switching of squirrel-cage motors while starting  
 $U_e = 400...415$  VAC

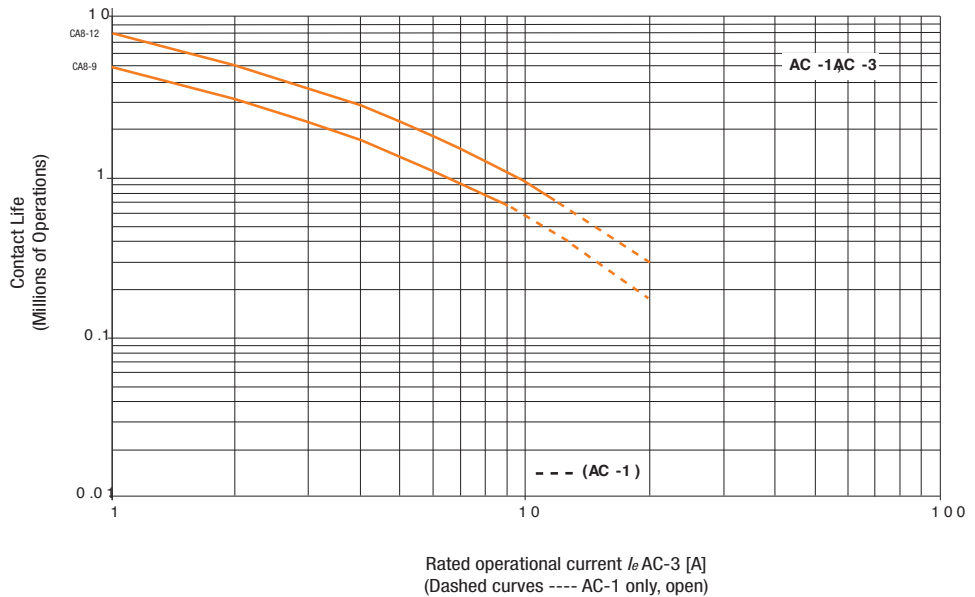

**AC-4**  
(400...460V AC)

AC-4 Stepping of squirrel-cage motors  
 $U_e = 400...415$  VAC



**NOTE:** The life-load curves shown here are based on Sprecher+Schuh tests according to the requirements defined in IEC 60947-4-1. Since contact life in any given application is dependent on environmental conditions and duty cycle, actual application contact life may vary from that indicated by the curves shown here.

Series CA8 & Series CAU8 (Contactors & Reversing Contactors)

Dimensions are in millimeters (inches). Dimensions not intended for manufacturing purposes.

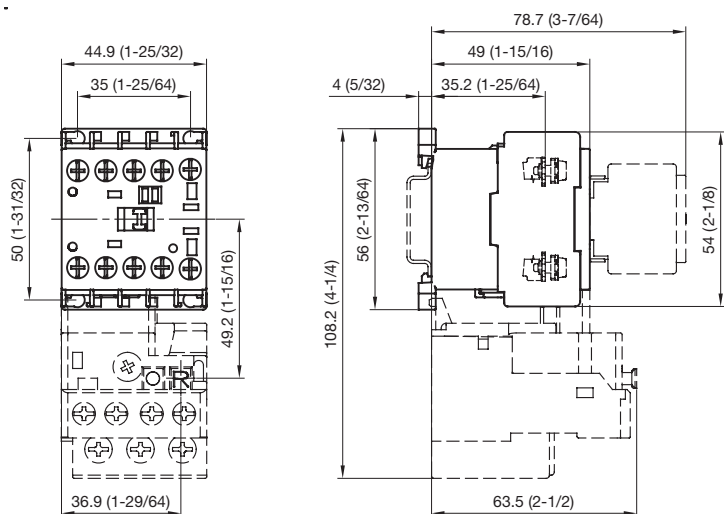

Mounting Position with Accessories

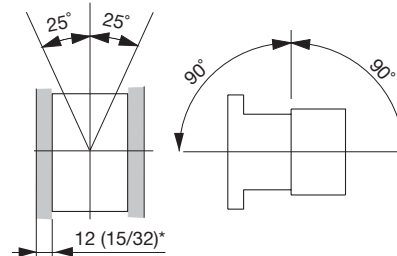

\* Minimum distance to grounded parts or walls

Reversing Contactors & Accessories

Contactor with...	Dim. [mm]	Dim. [inches]
reversing with mechanical interlock	89.8	3.53
with aux. contact block	78.7	3.1
with timer		
on contactor	81.7	3.25
at side of contactor	66.9	2.63
with neutral terminal		
at side of contactor	64.9	2.56
with protection element		
with nameplate	51	2

# Series CA7 Contactors

Rugged, space saving and modular... Sprecher + Schuh's contactor for applications up to 75HP @ 460V



Over 100 years of design experience has produced Sprecher + Schuh's seventh generation contactor line. The CA7 represents the most modern and flexible power contactor available today, meeting the highest industrial application requirements.

## Big performance in a small package

A wide selection of contactors in four frame sizes covers the entire CA7 horsepower range (up to 75HP @ 460/575V). Six of the contactors are only 45mm wide, an extremely small footprint for such rugged performance. A number of design features account for this efficiency, including high contact pressure and "bounce-free" contacts, allowing the devices to handle the high starting currents typical of modern motors.

## Type 1 and Type 2 Coordination

Whether you're designing motor circuits for use in North America, Europe or any other part of the world, all CA7 contactors have been designed and tested with respect to Type 1 and Type 2 short circuit coordination. Find out more in the CA7 Technical Information section in this chapter.

## Advanced safety and reliability features

The entire CA7 line features mechanically linked contacts, sometimes referred to as "positively guided contacts" or "force guided contacts". If a main power pole welds, adequate clearances exist ( $\geq 0.3\text{mm}$ ) to ensure that the auxiliary contacts do not change state when coil power is removed and the device tries to open. This is a requirement in safety circuits per IEC 60947-5-1.

Reliability is further assured by "cross-stamped" auxiliary contacts, which provide multi-point reliability in low current, low voltage applications.

## Advantages of Electronic DC Coil

CA7-9E through CA7-55E are provided with DC coils that dramatically decrease wattage consumption during pull-in. This allows the use of smaller power supplies. The electronic DC coil design allows the height of the contactor to be the same size as the AC version. Larger CA7 contactors are available with a two-winding DC coil that also reduces the size of the contactor as well as the hold-in values.

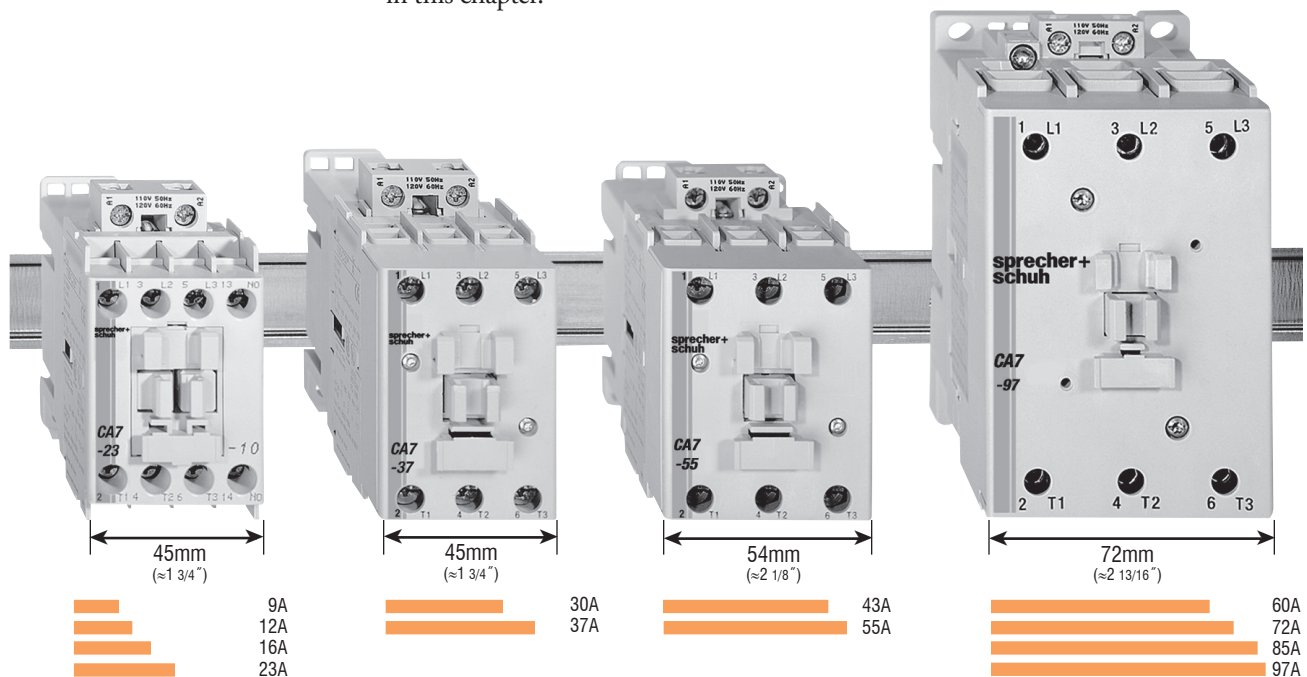

## Modular accessories are common to all devices

All accessories are interchangeable among all CA7 contactors and CS7 control relays. This minimizes inventory requirements and maximizes flexibility. Top and side mount auxiliary contacts are available depending on your application. A mechanical interlock with two built-in NC auxiliaries also provides electrical interlocking if desired. Pneumatic and electronic timers, surge suppressors and electronic interface modules provide solutions for even the most complex applications.

## Reversible coil provides

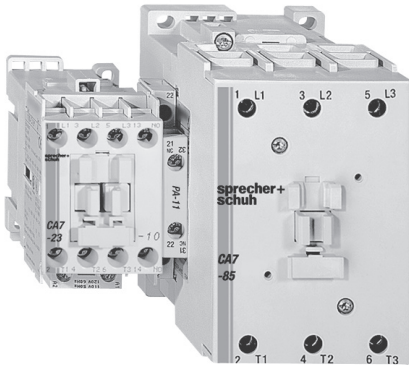

## total flexibility

When shipped, both coil connections are normally located at the top of the contactor in preparation for mounting an overload relay at the bottom. For multi-starter panels, however, the coil can be reversed, which provides space to close-couple a KT7 Motor Circuit Controller on the top of the contactor. CA7 contactors can either be ordered with the coil reversed or may be easily reversed in the field.

## Dual power terminals speed wiring

CA7-30 through 97 contactors are designed with two power terminals for all three poles. This simplifies power wiring of interconnected contactors in reversing, reduced voltage and two-speed applications. Preformed power wiring connectors are also available for virtually instantaneous wiring in these labor intensive applications. Simplified wiring means less labor and less cost.

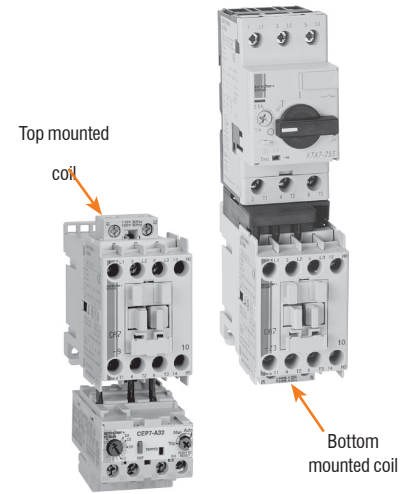

Reversible coils are standard on all CA7 contactors

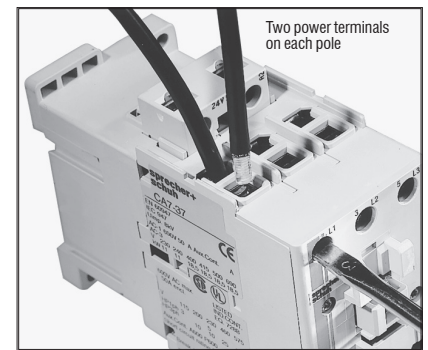

Dual power terminals assure hassle-free wiring in complex control schemes

## Special use contactors for specialized applications

The CA7 line includes a number of contactors designed and labeled for specific industrial applications. In all cases, these devices are UL and CSA approved for these specialized uses.

### Lighting contactors

The CAL7 contactor can be used to control a wide variety of lighting loads. These contactors are well suited to handle the high inrush currents typical of this application as well as other non-motor (resistive) loads. Both mechanically held and electrically held models are available for lighting load applications up to 20A, 30A and 60A.

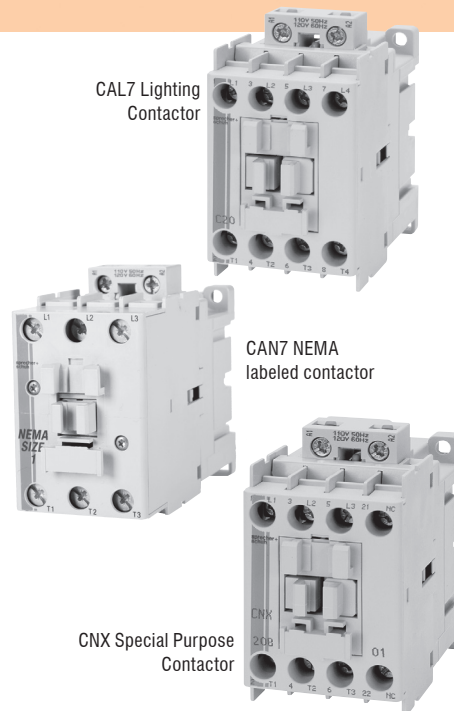

## NEMA Labeled Contactors

CAN7 contactors are UL Listed and rated in accordance with the requirements of NEMA standards publication ICS-2. These contactors are NEMA compliant and are labeled accordingly.

## Special purpose contactors

CNX contactors are standard CA7 contactors that have been tested, approved and labeled by UL for heating ventilation and air conditioning (HVAC) applications.

Sprecher + Schuh's CA7 line includes contactors designed and labeled for specific industrial applications

### Non-Reversing, Three Pole Contactors With AC Coil, Series CA7 (Open type only) ❶

I <sub>e</sub> [A] ❶		Ratings for Switching AC Motors (AC2 / AC3 / AC4)										Auxiliary Contacts per Contactor		Open Type  Catalog Number
		kW (50 Hz)				UL/CSA HP (60 Hz)								
		AC-3	AC-1	230V	400V/ 415V	500V	690V	1 Ø		3 Ø				
115V	230V							200V	230V	460V	575V			
9	32	3	4	4	4	1/2	1 1/2	2	2	5	7-1/2	1	0	CA7-9-10-* CA7-9-01-*
12	32	4	5.5	5.5	5.5	1/2	2	3	3	7-1/2	10	1	0	CA7-12-10-* CA7-12-01-*
16	32	5.5	7.5	7.5	7.5	1	3	5	5	10	15	1	0	CA7-16-10-* CA7-16-01-*
23	32	7.5	11	13	10	2	3	5	7-1/2	15	15	1	0	CA7-23-10-* CA7-23-01-*
30	65	10	15	15	15	2	5	7-1/2	10	20	25	0	0	CA7-30-00-* CA7-30-10-* CA7-30-01-*
37	65	11	18.5/ 20	20	18.5	3	5	10	10	25	30	0	0	CA7-37-00-* CA7-37-10-* CA7-37-01-*
43	85	13	22	25	22	3	7-1/2	10	15	30	30	0	0	CA7-43-00-* CA7-43-10-* CA7-43-01-*
55	85	15	30	30	22	5	10	15	20	40	40	0	0	CA7-55-00-* CA7-55-10-* CA7-55-01-*
60	100	18.5	32	37	32	5	10	15	20	40	50	0	0	CA7-60-00-* CA7-60-10-* CA7-60-01-*
72	100	22	40	45	40	5	15	20	25	50	60	0	0	CA7-72-00-* CA7-72-10-* CA7-72-01-*
85	100	25	45	55	45	7-1/2	15	25	30	60	60	0	0	CA7-85-00-* CA7-85-10-* CA7-85-01-*
97	130	30	55	55	55	10	20	30	30	75	75	0	0	CA7-97-00-* CA7-97-10-* CA7-97-01-*



CA7-9-10 contactor

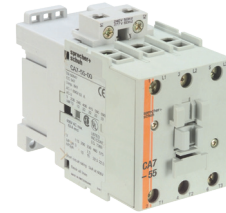

CA7-55-00 contactor



CA7-97-00 contactor

### Coil Codes ❷

AC Coil Code	Voltage Range	
	50 Hz	60 Hz
24Z	24V	24V
120	110V	120V
220W	200-220V	208-240V
230Z	230V	230V
277	240V	277V
415	400-415V	~
480	440V	480V
600	550V	600V

### Coil Terminal Position ❸

All CA7 contactors are stocked and delivered with the coil terminals located on the line side (top) of the contactor. This is the typical configuration when using the contactor with an overload relay. When the contactor is used with the KT7 Motor Circuit Controller, the coil must be reversed, so that the coil terminals are located at the load side (bottom) of the contactor. CA7 coils can easily be reversed in the field, however, they are also available for order with the coils reversed from the factory. Contact your Sprecher + Schuh representative for more information about ordering CA7 contactors with reversed coils.

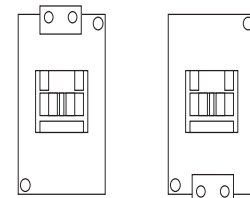

All CA7 contactors come with reversible coils.

### Ordering Instructions

Specify Catalog Number	
Replace (*) with Coil Code	See Coil Codes on this page.

- ❶ AC1 Resistive Ratings and UL/CSA Continuous Current Ratings may be increased by the use of Lug Kits or Paralleling Links. See CA7 Accessories section for applicable information.
- ❷ Other voltages available, see page A56.
- ❸ For coil terminals on the load side (bottom) add a **U** in front of the coil code. For example: CA7-23-10-120 becomes CA7-23-10-**U**120.



### Non-Reversing, Four Pole Contactors With AC Coil, Series CA7 (Open type only)

I <sub>e</sub> [A]		Ratings for Switching AC Motors (AC2 / AC3 / AC4)										Contact Configuration, Main Pole		Open Type Catalog Number
		kW (50 Hz)				UL/CSA HP (60 Hz)								
		230V	400V 415V	500V	690V	1 Ø		3 Ø						
115V	230V					200V	230V	460V	575V					
AC-3	AC-1	230V	400V 415V	500V	690V	115V	230V	200V	230V	460V	575V	NO	NC	Open Type Catalog Number
9	32	3	4	4	4	1/2	1 1/2	2	2	5	7-1/2	4	0	CA7-9-M40-*
												3	1	CA7-9-M31-*
												2	2	CA7-9-M22-*
12	32	4	5.5	5.5	5.5	1/2	2	3	3	7-1/2	10	4	0	CA7-12-M40-*
												3	1	CA7-12-M31-*
												2	2	CA7-12-M22-*
16	32	5.5	7.5	7.5	7.5	1	3	5	5	10	15	4	0	CA7-16-M40-*
												3	1	CA7-16-M31-*
												2	2	CA7-16-M22-*
23	32	7.5	11	13	10	2	3	5	7-1/2	15	15	4	0	CA7-23-M40-*
												3	1	CA7-23-M31-*
												2	2	CA7-23-M22-*
37	75	11	18.5	20	18.5	3	5	10	10	25	30	4	0	CA7-40-M40-*
37	75	11	18.5/20	18.5	7.5	3	5	10	10	25	15	2	2	CA7-40-M22-*
85	130	25	45	55	45	7-1/2	15	25	30	60	50	4	0	CA7-90-M40-*
85	130	25	45	55	18.5	7-1/2	15	25	30	50	20	2	2	CA7-90-M22-*



CA7-23-M22-120 contactor

### Coil Codes ❶

AC Coil Code	Voltage Range	
	50 Hz	60 Hz
24Z	24V	24V
120	110V	120V
220W	200-220V	208-240V
230Z	230V	230V
277	240V	277V
415	400-415V	~
480	440V	480V
600	550V	600V

### Coil Terminal Position ❷

All CA7 contactors are stocked and delivered with the coil terminals located on the line side (top) of the contactor. This is the typical configuration when using the contactor with an overload relay. When the contactor is used with the KT7 Motor Circuit Controller, the coil must be reversed, so that the coil terminals are located at the load side (bottom) of the contactor. CA7 coils can easily be reversed in the field, however, they are also available for order with the coils reversed from the factory. Contact your Sprecher+Schuh representative for more information about ordering CA7 contactors with reversed coils.

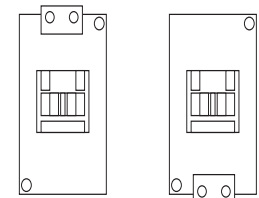

All CA7 contactors come with reversible coils.

### Ordering Instructions

Specify Catalog Number	
Replace (*) with Coil Code	See Coil Codes on this page.

❶ Other voltages available, see page A56.

❷ For coil terminals on the load side (bottom) add a U in front of the coil code. For example: CA7-23-M40-120 becomes CA7-23-M40-U120.

### Non-Reversing, Three Pole Contactors With Electronic DC Coil, Series CA7 (Open type only) ①②③

I <sub>e</sub> [A] ①		Ratings for Switching AC Motors (AC2 / AC3 / AC4)										Auxiliary Contacts per Contactor		Open Type  Catalog Number	
		kW (50 Hz)				UL/CSA HP (60 Hz)									
		AC-3	AC-1	230V	400V/ 415V	500V	690V	1 Ø		3 Ø					
115V	230V							200V	230V	460V	575V				
9	32	3	4	4	4	1/2	1 1/2	2	2	5	7-1/2	1 0	0 1	CA7-9E-10-* CA7-9E-01-*	
12	32	4	5.5	5.5	5.5	1/2	2	3	3	7-1/2	10	1 0	0 1	CA7-12E-10-* CA7-12E-01-*	
16	32	5.5	7.5	7.5	7.5	1	3	5	5	10	15	1 0	0 1	CA7-16E-10-* CA7-16E-01-*	
23	32	7.5	11	13	10	2	3	5	7-1/2	15	15	1 0	0 1	CA7-23E-10-* CA7-23E-01-*	
30	65	10	15	15	15	2	5	7-1/2	10	20	25	0 1 0	0 0 1	CA7-30E-00-* CA7-30E-10-* CA7-30E-01-*	
37	65	11	18.5/ 20	20	18.5	3	5	10	10	25	30	0 1 0	0 0 1	CA7-37E-00-* CA7-37E-10-* CA7-37E-01-*	
43	85	13	22	25	22	3	7-1/2	10	15	30	30	0 1 0	0 0 1	CA7-43E-00-* CA7-43E-10-* CA7-43E-01-*	
55	85	15	30	30	22	5	10	15	20	40	40	0 1 0	0 0 1	CA7-55E-00-* CA7-55E-10-* CA7-55E-01-*	



CA7-16E-10-110E contactor ④



CA7-23E-10-24E contactor



CA7-55E-00-24E contactor

#### Description

Low Consumption Electronic DC coils have extremely low inrush which allows the use of smaller power supplies. CA7-9E...55E has internal surge suppression. See page A69 for more information.

This new design results in:

- Lighter, lower depth
- More energy efficient contactors
- Easier wiring
- Uniform panel appearance.

#### Applications

Direct control from PLC:

The low power consumption contactor designed to control motors and other loads is especially aligned to the specific requirement of electronic control circuits. The low power consumption of 1.7 allows direct control through PLC's without the need for interposing relays. Power dissipation is greatly reduced limiting the heat effect in control panels.

#### Coil Codes ②④

DC Coil Codes	Voltage
12E	12V
24E	24V
36E ⑤	36-48V
48E ⑤	48-72V
110E ⑤	110-125V
220E ⑤	220-250V

#### Coil Terminal Position ⑥

All CA7 contactors are stocked and delivered with the coil terminals located on the line side (top) of the contactor. This is the typical configuration when using the contactor with an overload relay. When the contactor is used with the KT7 Motor Circuit Controller, the coil must be reversed, so that the coil terminals are located at the load side (bottom) of the contactor. CA7 coils can easily be reversed in the field, however, they are also available for order with the coils reversed from the factory. Contact your Sprecher+Schuh representative for more information about ordering CA7 contactors with reversed coils.

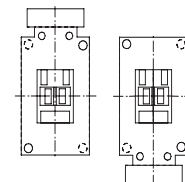

All CA7 contactors come with reversible coils. (48V DC shown)

① AC1 Resistive Ratings and UL/CSA Continuous Current Ratings may be increased by the use of Lug Kits or Paralleling Links. See CA7 Accessories section for applicable information.

② CA7-9E...55E with electronic coils are not interchangeable with non-electronic DC or AC coils.

③ See page A47-A48 for limitations on adding auxiliaries to Electronic DC Coil contacts.

④ Voltages of 36V DC and greater are supplied with backpack module standard. See page A86.

⑤ Not applicable with Electronic Timer accessories (CRZ\_7).

⑥ For coil terminals on the load side (bottom) add a **U** in front of the coil code. For example: CA7-23E-10-24E becomes CA7-23E-10-**U**24E.

**Non-Reversing, Four Pole Contactors With Electronic DC Coil, Series CA7 (Open type only) ①②**

$I_e$ [A]		Ratings for Switching AC Motors (AC2 / AC3 / AC4)										Contact Configuration, Main Pole		Open Type
		kW (50 Hz)				UL/CSA HP (60 Hz)								
		230V		400V 415V	500V	690V	1 Ø		3 Ø					
AC-3	AC-1	230V	400V 415V	500V	690V	115V	230V	200V	230V	460V	575V	NO	NC	Catalog Number
9	32	3	4	4	4	1/2	1 1/2	2	2	5	7-1/2	4 3 2	0 1 2	CA7-9E-M40-* CA7-9E-M31-* CA7-9E-M22-*
12	32	4	5.5	5.5	5.5	1/2	2	3	3	7-1/2	10	4 3 2	0 1 2	CA7-12E-M40-* CA7-12E-M31-* CA7-12E-M22-*
16	32	5.5	7.5	7.5	7.5	1	3	5	5	10	15	4 3 2	0 1 2	CA7-16E-M40-* CA7-16E-M31-* CA7-16E-M22-*
23	32	7.5	11	13	10	2	3	5	7-1/2	15	15	4 3 2	0 1 2	CA7-23E-M40-* CA7-23E-M31-* CA7-23E-M22-*
37	75	11	18.5	20	18.5	3	5	10	10	25	30	4	0	CA7-40E-M40-*
37	75	11	18.5/20	18.5	7.5	3	5	10	10	25	15	2	2	CA7-40E-M22-*

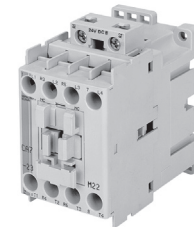

CA7-23E-M22-24E contactor

**Description**

Low Consumption Electronic DC coils have extremely low inrush which allows the use of smaller power supplies. CA7-9E...55E have internal surge suppression. See page A74 for more information.

This design results in:

- Lighter, lower depth
- More energy efficient contactors
- Easier wiring
- Uniform panel appearance

**Applications**

Direct control from PLC:

The low power consumption contactor designed to control motors and other loads is especially aligned to the specific requirement of electronic control circuits. The low power consumption of 1.7 allows direct control through PLC's without the need for interposing relays. Power dissipation is greatly reduced limiting the heat effect in control panels.

**Coil Codes ①③**

DC Coil Codes	Voltage
12E	12V
24E	24V
36E ④	36-48V
48E ④	48-72V
110E ④	110-125V
220E ④	220-250V

**Coil Terminal Position ⑤**

All CA7 contactors are stocked and delivered with the coil terminals located on the line side (top) of the contactor. This is the typical configuration when using the contactor with an overload relay. When the contactor is used with the KT7 Motor Circuit Controller, the coil must be reversed, so that the coil terminals are located at the load side (bottom) of the contactor. CA7 coils can easily be reversed in the field, however, they are also available for order with the coils reversed from the factory. Contact your Sprecher+Schuh representative for more information about ordering CA7 contactors with reversed coils.

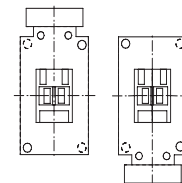

All CA7 contactors come with reversible coils. (48V DC shown)

- ① CA7-9E...55E with electronic coils are not interchangeable with non-electronic DC or AC coils
- ② See pages A47-A48 for limitations on adding auxiliaries to Electronic DC Coil contacts.
- ③ Voltages of 36V DC and greater are supplied with backpack module standard. See page A86.

- ④ Not applicable with Electronic Timer accessories (CRZ\_7).
- ⑤ For coil terminals on the load side (bottom) add a **U** in front of the coil code. For example: CA7-23E-M40-24E becomes CA7-23E-M40-**U**24E.

#### Non-Reversing, Three Pole Contactors With Two Winding DC Coil, Series CA7 (Open type only) ①

I <sub>e</sub> [A]		Ratings for Switching AC Motors (AC2 / AC3 / AC4)										Auxiliary Contacts per Contactor ①		Open Type
		kW (50 Hz)				UL/CSA HP (60 Hz)								
		AC-3	AC-1	230V	400V/415V	500V	690V	1 Ø		3 Ø				
115V	230V							200V	230V	460V	575V			
60	100	18.5	32	37	32	5	10	15	20	40	50	0	0	CA7-60D-00-*
												1	0	CA7-60D-10-*
												0	1	CA7-60D-01-*
72	100	22	40	45	40	5	15	20	25	50	60	0	0	CA7-72D-00-*
												1	0	CA7-72D-10-*
												0	1	CA7-72D-01-*
85	100	25	45	55	45	7-1/2	15	25	30	60	60	0	0	CA7-85D-00-*
												1	0	CA7-85D-10-*
												0	1	CA7-85D-01-*
97	130	30	55	55	55	10	20	30	30	75	75	0	0	CA7-97D-00-*
												1	0	CA7-97D-10-*
												0	1	CA7-97D-01-*

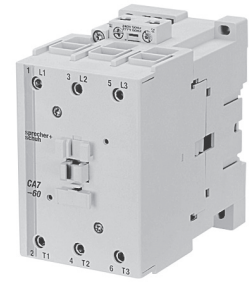

CA7-60D Contactor

#### Description:

Contactors with two winding DC coils have very low hold-in values and share the same dimensions with AC contactors. See page A57 for more information. See page A87 for dimensional information.

#### Non-Reversing, Four Pole Contactors With Two Winding DC Coil, Series CA7 (Open type only) ①

I <sub>e</sub> [A]		Ratings for Switching AC Motors (AC2 / AC3 / AC4)										Contact Configuration Main Pole		Auxiliary Contacts per Contactor		Open Type
		kW (50 Hz)				UL/CSA HP (60 Hz)										
		AC-3	AC-1	230V	415V/400V	500V	690V	1 Ø		3 Ø						
115V	230V							200V	230V	460V	575V					
85	130	25	45	55	45	7-1/2	15	25	30	60	50	4	0	0	0	CA7-90D-M40-*
85	130	25	45	55	18.5	7-1/2	15	25	30	50	20	2	2	0	0	CA7-90D-M22-*

#### Coil Codes ②③④

DC Coil Code	Voltage
24DD	24V
110DD	110V

#### Ordering Instructions

Specify Catalog Number	
Replace (*) with Coil Code	See Coil Codes on this page.

- ① CA7-60D...CA7-97D have an internal auxiliary contact to transition from the start winding to the run winding.
- ② Coils include an integrated diode surge suppressor.
- ③ Other coil voltages are available, see page A57. Contact your Sprecher + Schuh Sales Representative to determine which coil voltages may be stocked.
- ④ The coil codes shown are the most commonly stocked items. Contact your Sprecher + Schuh representative to determine if other voltages, i.e., 12DD, 48DD, 220DD are on-hand or can be specially ordered in quantities.

### Reversing, Three Pole Contactors With AC Coil, Series CAU7 (Open type only)

I <sub>e</sub> [A]		Ratings for Switching AC Motors (AC2 / AC3 / AC4)										Auxiliary Contacts per Contactor		Open Type
		kW (50 Hz)				UL/CSA HP (60 Hz)								
		230V		400V 415V	500V	690V	1 Ø		3 Ø					
AC-3	AC-1	230V	400V 415V	500V	690V	115V	230V	200V	230V	460V	575V	NO	NC ⑤	Catalog Number
9	32	3	4	4	4	1/2	1 1/2	2	2	5	7-1/2	1	1	CAU7-9-22-*
12	32	4	5.5	5.5	5.5	1/2	2	3	3	7-1/2	10	1	1	CAU7-12-22-*
16	32	5.5	7.5	7.5	7.5	1	3	5	5	10	15	1	1	CAU7-16-22-*
23	32	7.5	11	13	10	2	3	5	7-1/2	15	15	1	1	CAU7-23-22-*
30	65	10	15	15	15	2	5	7-1/2	10	20	25	0	1	CAU7-30-02-*
												1 ④	1	CAU7-30-22-*
37	65	11	18.5/20	20	8.5	3	5	10	10	25	30	0	1	CAU7-37-02-*
												1 ④	1	CAU7-37-22-*
43	85	13	22	25	22	3	7-1/2	10	15	30	30	0	1	CAU7-43-02-*
												1 ④	1	CAU7-43-22-*
55	85	15	30	30	22	5	10	15	20	40	40	0	1	CAU7-55-02-*
												1 ④	1	CAU7-55-22-*
60	100	18.5	32	37	32	5	10	15	20	40	50	0	1	CAU7-60-02-*
												1 ④	1	CAU7-60-22-*
72	100	22	40	45	40	5	15	20	25	50	60	0	1	CAU7-72-02-*
												1 ④	1	CAU7-72-22-*
85	100	25	45	55	45	7-1/2	15	25	30	60	60	0	1	CAU7-85-02-*
												1 ④	1	CAU7-85-22-*
97	130	30	55	55	55	10	20	30	30	75	75	0	1	CAU7-97-02-*
												1 ④	1	CAU7-97-22-*

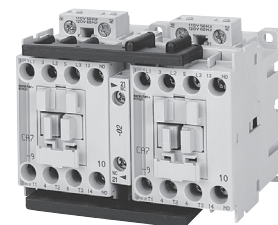

CAU7-9-22-120 reversing contactor

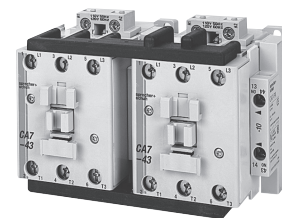

CAU7-43-22-120 reversing contactor

#### Includes:

- Line side coil terminations
- Mechanical and electrical Interlock ⑤
- Reversing power wiring ① (using Power Wiring Kit Cat.# CAU7-PW...)
- Control wiring available; see footnote ②

### Coil Codes ⑤

AC Coil Code	Voltage Range	
	50 Hz	60 Hz
24Z	24V	24V
120	110V	120V
220W	200-220V	208-240V
230Z	230V	230V
277	240V	277V
415	400-415V	~
480	440V	480V
600	550V	600V

### Ordering Instructions

Specify Catalog Number	
Replace (*) with Coil Code	See Coil Codes on this page.

- ① For Reversing Contactors *without* power wiring add suffix "-LW" to catalog number. For example: CAU7-9-22-\* becomes CAU7-9-22-\***LW**. CAU7-60...97 not available without power wiring. Price reduction applies.
- ② For control wiring, add suffix **-CW** to catalog number. Example: CAU7-9-22-\* becomes CAU7-9-22-\***CW**. Price addition applies.
- ③ The NC auxiliary contacts are supplied as part of the mechanical interlock (Cat.# CM7-02) and are used to electrically interlock the contactors.
- ④ The NO auxiliary contacts supplied are side mounted. Top mount NO auxiliary contacts must be special ordered. Contact your Sprecher+Schuh representative.
- ⑤ Other voltages available, see page A56.

### Reversing, Three Pole Contactors With Electronic DC Coil, Series CAU7 (Open type only) ⑥⑦

I <sub>e</sub> [A]		Ratings for Switching AC Motors (AC2 / AC3 / AC4)										Auxiliary Contacts per Contactor		Open Type
		kW (50 Hz)				UL/GSA HP (60 Hz)								
		AC-3	AC-1	230V	400V 415V	500V	690V	1 Ø		3 Ø				
115V	230V			200V	230V	460V	575V	NO	NC ③	Catalog Number				
9	32	3	4	4	4	1/2	1 1/2	2	2	5	7-1/2	1	1	CAU7-9E-22-*
12	32	4	5.5	5.5	5.5	1/2	2	3	3	7-1/2	10	1	1	CAU7-12E-22-*
16	32	5.5	7.5	7.5	7.5	1	3	5	5	10	15	1	1	CAU7-16E-22-*
23	32	7.5	11	13	10	2	3	5	7-1/2	15	15	1	1	CAU7-23E-22-*
30	65	10	15	15	15	2	5	7-1/2	10	20	25	0 1 ④	1 1	CAU7-30E-02- CAU7-30E-22-*
37	65	11	18.5/ 20	20	8.5	3	5	10	10	25	30	0 1 ④	1 1	CAU7-37E-02- CAU7-37E-22-*
43	85	13	22	25	22	3	7-1/2	10	15	30	30	0 1 ④	1 1	CAU7-43E-02- CAU7-43E-22-*
55	85	15	30	30	22	5	10	15	20	40	40	0 1 ④	1 1	CAU7-55E-02- CAU7-55E-22-*

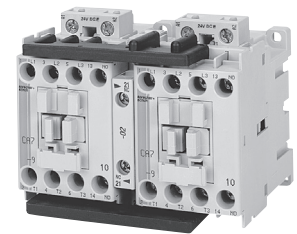

CAU7-9E-22-24E Reversing contactor



CAU7-37E-22-24E Reversing contactor

#### Description

Low Consumption Electronic DC coils have extremely low inrush which allows the use of smaller power supplies. CA7-9E...55E have internal surge suppression. See page A69 for more information.

This new design results in:

- Lighter, lower depth
- More energy efficient contactors
- Easier wiring
- Uniform panel appearance

#### Applications

Direct control from PLC:

The low power consumption contactor designed to control motors and other loads is especially aligned to the specific requirement of electronic control circuits. The low power consumption of 1.7 allows direct control through PLC's without the need for interposing relays. Power dissipation is greatly reduced limiting the heat effect in control panels.

#### Includes:

- Line side coil terminations
- Mechanical and electrical Interlock ③
- Reversing power wiring ① (using Power Wiring Kit Cat.# CAUT7-PW...)
- Control wiring available; see footnote ②
- CAU7-9E...55E has internal surge suppression.

#### Coil Codes ⑥⑦

DC Coil Codes	Voltage
12E	12V
24E	24V
36E ③	36-48V
48E ③	48-72V
110E ③	110-125V
220E ③	220-250V

① For Reversing Contactors without power wiring add suffix "-LW" to catalog number. For example CAU7-9E-22-24E becomes CAU7-9E-22-24E-LW. Price reduction applies.

② For control wiring, add suffix "-CW" to catalog number. For example: CAU7-9E-22-24E becomes CAU7-9E-22-24E-CW. Price addition applies.

③ The NC auxiliary contacts are supplied as part of the mechanical interlock (Cat.# CM7-02) and are used to electrically interlock the contactors.

④ The NO auxiliary contacts supplied are side mounted. Top mount NO auxiliary contacts must be special ordered. Contact your Sprecher+Schuh representative.

⑥ CA7-9E...55E with electronic coils are not interchangeable with non-electronic DC or AC coils.

⑦ See pages A47-A48 for limitations. on adding auxiliaries to Electronic DC Coil contacts.

⑧ Voltages of 36V DC and greater are supplied with backpack module standard. See page A86.

⑨ Not applicable with Electronic Timer accessories (CRZ\_7).

**Reversing, Three Pole Contactors With DC Coil, Series CAU7 (Open type only)**

I <sub>e</sub> [A]		Ratings for Switching AC Motors (AC2 / AC3 / AC4)										Auxiliary Contacts per Contactor		Open Type Catalog Number
		kW (50 Hz)				UL/CSA HP (60 Hz)								
		AC-3	AC-1	230V	400V 415V	500V	690V	1 Ø		3 Ø				
115V	230V							200V	230V	460V	575V			
60	100	18.5	32	37	32	5	10	15	20	40	50	0	1	CAU7-60D-02-*
												1	1	CAU7-60D-22-*
72	100	22	40	45	40	5	15	20	25	50	60	0	1	CAU7-72D-02-*
												1	1	CAU7-72D-22-*
85	100	25	45	55	45	7-1/2	15	25	30	60	60	0	1	CAU7-85D-02-*
												1	1	CAU7-85D-22-*
97	130	30	55	55	55	10	20	30	30	75	75	0	1	CAU7-97D-02-*
												1	1	CAU7-97D-22-*

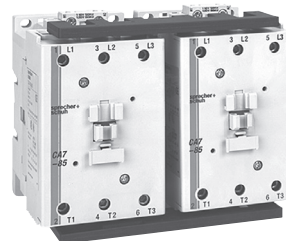

CAU7-85D Reversing (Typical)

**NOTE:** DC and AC coils are not interchangeable. CA7-60D...97D contactors have a two winding, 3-lead coil with built-in late break auxiliary contact and coil suppression. Refer to dimensions starting on page A87.

**Includes:**

- DC operating mechanism
- Line side coil terminations
- Mechanical and electrical Interlock ②
- Reversing power wiring
- Control wiring available; see footnote ①

**Coil Codes ④⑤**

DC Coil Code	Voltage
24DD	24V
110DD	110V

**Ordering Instructions**

Specify Catalog Number	
Replace (*) with Coil Code	<b>See Coil Codes on this page.</b>

- ① For control wiring, add suffix **-CW** to catalog number. For example: CAU7-60D-22-\* becomes CAU7-60D-22-\***-CW**. Price addition applies.
- ② The NC auxiliary contacts are supplied as part of the mechanical interlock (Cat.# CM7-02) and are used to electrically interlock the contactors.
- ③ The NO auxiliary contacts supplied are side mounted. Top mount NO auxiliary contacts must be special ordered. Contact your Sprecher+Schuh representative.
- ④ Other voltages available, see page A57.
- ⑤ Coils for CAU7-60D...97D reversing contactors include an integrated diode surge suppressor.

# Series CA7 Special Use Contactors

Contactors designed and labeled for specific industrial applications



## Special Use Contactors

Hydraulic elevator duty contactors

HVAC rated contactors

Lighting contactors

NEMA size labeled contactors

The CA7 line includes a number of contactors designed and labeled for specific industrial applications. In most cases, these devices are UL and CSA approved for these specialized uses. Where appropriate, contactors also carry approval by specific industry associations such as ARI (Air Conditioning and Refrigeration Institute).

## CNX Special Purpose Contactors

CNX Special Purpose Contactors are rated by FLA & LRA as well as resistive current rated - primarily to meet the demands of the HVAC and compressor markets. CNX contactors have all the flexibility of a CA7 contactor like easy coil change out, DIN rail mounting and field installable auxiliaries as well as mechanical interlocks not normally associated with true definite purpose contactors. CNX contactors may also be combined with CEP7 or CT7N overload relays to make a special purpose starter. CNX starters are cUL rated and labeled as well as ARI (Air Conditioning and Refrigeration Institute) approved.

## CAN7 NEMA size labeled contactors

CAN7 contactors are UL Listed in accordance with NEMA standards publication ICS-2. CAN7 contactors are UL labeled for application under IEC KW, as well as NEMA Size, for specified horsepower at various voltages. CAN7 contactors have been purposely selected larger to increase the life of the device. Only the devices listed here are available with the NEMA size on the UL label. CAN7 NEMA sized contactors may be combined with all Sprecher + Schuh overload relays to make a NEMA sized starter.

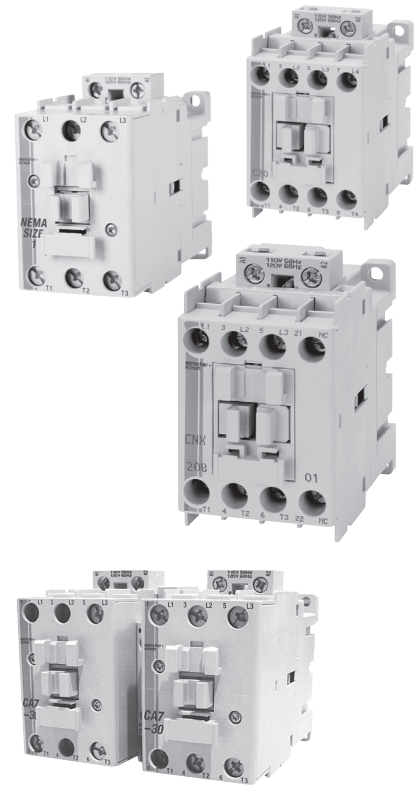

## Hydraulic Elevator Wye-Delta Contactors

Most industrial wye-deltas consist of three contactors with interlocks but Hydraulic Elevators are a special application. Hydraulic Elevator wye-deltas consist of a pair of mechanically linked contactors with sufficient auxiliaries for electrical interlocks. The wye-delta is similar to a reversing contactor but the power wiring is different. We offer Hydraulic Elevator contactors with a choice of power wiring inter-connections for ease of installation, or without power wiring inter-connections, allowing the elevator serviceman to make use of the existing power cables. This convenient selection of a complete assembly saves time and effort in the field.



**Non-Reversing, Three Pole Special Purpose Contactors With AC Coil (Open type only) ①**

Full Load Amps	Locked Rotor Amps - 3Ø			Resistive Amps ②	Maximum Horsepower						Auxiliary Contacts per Contactor		Catalog Number
					1 Ø		3 Ø						
	200V/230V	460V	575V		115V	230V	200V/208V	230V	460V	575V	NO	NC	
15	91	91	66	25	1-1/2	3	4	5	10	10	1	0	<b>CNX-205-*</b>
											0	1	<b>CNX-206-*</b>
30	180	150	120	40	2	5	7-1/2	10	20	20	1	0	<b>CNX-207-*</b>
											0	1	<b>CNX-208-*</b>
40	240	200	160	50	3	5	10	10	25	25	0	0	<b>CNX-209-00-*</b>
											1	0	<b>CNX-209-10-*</b>
											0	1	<b>CNX-209-01-*</b>
50	300	250	200	65	3	7-1/2	10	15	30	30	0	0	<b>CNX-212-00-*</b>
											1	0	<b>CNX-212-10-*</b>
											0	1	<b>CNX-212-01-*</b>
90	540	450	360	120	~	~	25	30	60	60	0	0	<b>CNX-218-00-*</b>
											1	0	<b>CNX-218-10-*</b>
											0	1	<b>CNX-218-01-*</b>



CNX-208-120  
 Special Purpose contactor

**Description**

Series CNX Special Purpose Contactors are standard CA7 contactors that have been tested, approved and labeled by UL for heating, ventilation and air conditioning (HVAC) applications. ②

**Coil Codes ②**

AC Coil Code	Voltage Range	
	50 Hz	60 Hz
<b>24Z</b>	<b>24V</b>	<b>24V</b>
<b>120</b>	<b>110V</b>	<b>120V</b>
<b>220W</b>	<b>200-220V</b>	<b>208-240V</b>
<b>230Z</b>	230V	230V
<b>277</b>	240V	277V
<b>415</b>	400-415V	~
<b>480</b>	<b>440V</b>	<b>480V</b>
<b>600</b>	550V	600V

**Ordering Instructions**

Specify Catalog Number	
Replace (*) with Coil Code	<b>See Coil Codes on this page.</b>

- ① All CNX contactors listed here are ARI (Air Conditioning and Refrigeration Institute) approved.
- ② Other voltages available, see page A56.
- ③ Reference page A77 for Operation Life Data.

### Non-Reversing, Three Pole NEMA Labeled Contactors with AC Coil ①

NEMA Size	Continuous Ampere Rating [A]	Maximum Horsepower						Standard Auxiliary Contacts		Catalog Number
		1Ø		3Ø				NO	NC	
		115V	230V	200V	230V	460V	575V			
00	~	1/3	1	1-1/2	1-1/2	2	2	1	0	CAN7-12-10-*
0	18	1	2	3	3	5	5	1	0	CAN7-16-10-*
1	27	2	3	7-1/2	7-1/2	10	10	1	0	CAN7-37-10-*
2	45	3	7-1/2	10	15	25	25	1	0	CAN7-43-10-*
3	90	7-1/2	15	25	30	50	50	1	0	CAN7-85-10-*



CAN7 NEMA1 labeled contactor (AC)

#### Application Notes

- NEMA contactors are UL Listed and rated in accordance with the requirements of NEMA standards publication ICS-2. These contactors are labeled for applications that require compliance with NEMA standards.
- Sizes are based on standard NEMA classifications.
- Easy coil change. See page A56 for CAN7 coils.
- Snap-on auxiliary contact blocks available in many configurations. See pages A47-A48.
- Available as open units or in Type 1, 3R, 4, 4X and 12 enclosures. Contact your Sprecher + Schuh representative for enclosed pricing. NEMA sized starters with AC Coils are listed on page C52.

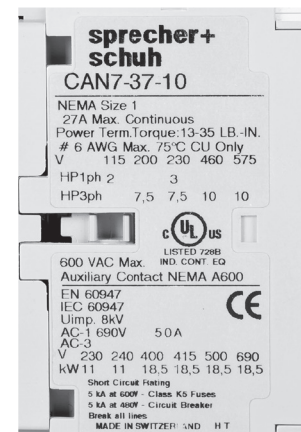

#### CAN7 AC Coil Codes ②

CAN7-12...85		
AC Coil Code	Voltage Range	
	50 Hz	60 Hz
24Z	24V	24V
120	110V	120V
220W	200-220V	208-240V
230Z	230V	230V
277	240V	277V
415	400-415V	~
480	440V	480V
600	550V	600V

#### Ordering Instructions

Specify Catalog Number	
Replace (*) with Coil Code	See Coil Codes on this page.

- ① Refer to page A85 for CAN7 dimensional information.
- ② Other voltages available, see page A56 for other coil voltage.

### Non-Reversing, Three Pole NEMA Labeled Contactors with DC Coil ❶

NEMA Size	Continuous Ampere Rating [A]	Maximum Horsepower						Standard Auxiliary Contacts		Catalog Number
		1Ø		3Ø				NO	NC	
		115V	230V	200V	230V	460V	575V			
00	~	1/3	1	1-1/2	1-1/2	2	2	1	0	CAN7-12E-10-*
0	18	1	2	3	3	5	5	1	0	CAN7-16E-10-*
1	27	2	3	7-1/2	7-1/2	10	10	1	0	CAN7-37E-10-*
2	45	3	7-1/2	10	15	25	25	1	0	CAN7-43E-10-*
3	90	7-1/2	15	25	30	50	50	2	1	CAN7-85D-10-*



CAN7 NEMA1 labeled contactor  
(24V Electronic DC shown)

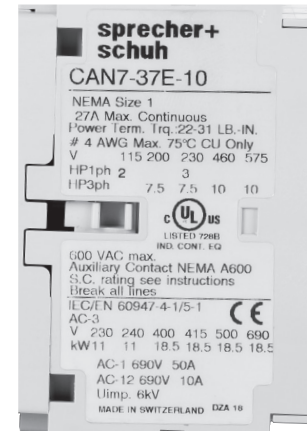

#### Application Notes

- NEMA contactors are UL Listed and rated in accordance with the requirements of NEMA standards publication ICS-2. These contactors are labeled for applications that require compliance with NEMA standards.
- Sizes are based on standard NEMA classifications.
- Easy coil change and contact replacement. See page A57 for CAN7 DC coils.
- Snap-on auxiliary contact blocks available in many configurations. See pages A47-A48.
- Available as open units or in Type 1, 3R, 4, 4X and 12 enclosures. Contact your Sprecher + Schuh representative for enclosed pricing. NEMA sized starters with AC Coils are listed on page C52.

### CAN7 Electronic DC Coil Codes ❸❹

CAN7-12E...43E	
DC Coil Code	Voltage Range
12E	12V
24E	24V
36E ❸	36-48V
48E ❸	48-72V
110E ❸	110-125V
220E ❸	220-250V

### CAN7 DC Coil Codes with integrated Diode ❺

CAN7-85D	
DC Coil Code	Voltage Range
24DD	24V
110DD	110V

### Ordering Instructions

Specify Catalog Number	
Replace (*) with Coil Code	See Coil Codes on this page.

- ❶ Refer to page A86-A87 for CAN7 dimensional information.
- ❷ Other voltages available, see page A57 for other coil voltage.
- ❸ CAN7-12E...43E electronic coils are not interchangeable with non-electronic DC or AC coils.
- ❹ Voltages of 36V DC and greater are supplied with backpack module standard. See page A86.
- ❺ Not applicable with Electronic Timer accessories (CRZ\_7).

#### Hydraulic Elevator Wye Delta, with AC Coils (Two Contactor Type ①)

Maximum Horsepower Three Phase				Auxiliary Contacts per Contactor		Open Type
200V	230V	460V	575V	NO ④	NC ⑤	Catalog No.
10 7.5	15 7.5	30 20	30 20	0 1	1 1	CA7Y2-30-02-*-LW CA7Y2-30-22-*-LW
15 7.5	20 10	40 20	40 25	0 1	1 1	CA7Y2-37-02-*-LW CA7Y2-37-22-*-LW
20 10	25 10	50 25	50 30	0 1	1 1	CA7Y2-43-02-*-LW CA7Y2-43-22-*-LW
25 10	30 15	60 30	60 40	0 1	1 1	CA7Y2-55-02-*-LW CA7Y2-55-22-*-LW
30 10	40 15	75 30	75 40	0 1	1 1	CA7Y2-60-02-*-LW CA7Y2-60-22-*-LW
40 15	50 20	100 40	100 50	0 1	1 1	CA7Y2-72-02-*-LW CA7Y2-72-22-*-LW
50 20	60 25	125 50	125 60	0 1	1 1	CA7Y2-85-02-*-LW CA7Y2-85-22-*-LW
50 25	60 30	125 60	125 75	0 1	1 1	CA7Y2-97-02-*-LW CA7Y2-97-22-*-LW

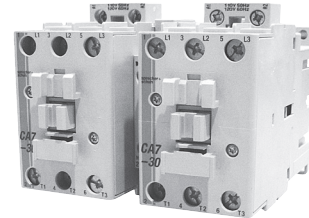

CA7Y2-30 Wye-Delta contactor

#### Includes:

- Line side coil terminations
- Mechanical and electrical Interlocks ②
- CA7Y2-60...97 include a back pan

#### Optional:

- Power Wiring available but not included (see page A55) ①⑦
- Elevator controllers often require additional auxiliary contacts. ③

#### HP Selection

Industrial Application ⑥	UL/CSA Elevator Duty ⑥
--------------------------	------------------------

Larger sizes available. Contact your Sprecher + Schuh representative.

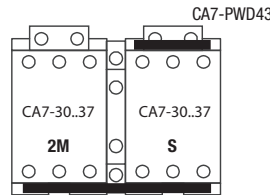

CA7-PWLM37M

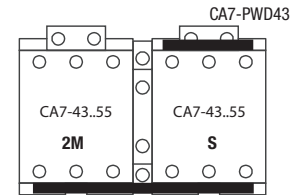

CA7-PWLM55M

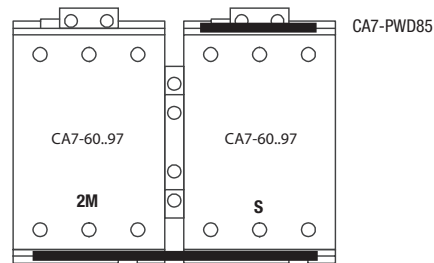

CA7-PWLM85M

#### Coil Codes ④

AC Coil Code	Voltage Range	
	50 Hz	60 Hz
24Z	24V	24V
120	110V	120V
220W	200-220V	208-240V
230Z	230V	230V
277	240V	277V
415	400-415V	~
480	440V	480V
600	550V	600V

#### Ordering Instructions

Specify Catalog Number	
Replace (*) with Coil Code	See Coil Codes on this page.

① For Contactors *with* power wiring change catalog number suffix “-LW” to “-PW”. Price addition applies. For example CA7Y2-30-22-\*-LW becomes CA7Y2-30-22-\*-PW.

NOTE: CA7Y2-30...55-22-\*-PW do not include a backpan.

② The NC auxiliary contacts are supplied as part of the mechanical interlock (Cat.# CM7-02) and are used to electrically interlock the contactors.

③ The NO auxiliary contacts supplied are side mounted. Top mount NO auxiliary contacts must be special ordered. Contact your Sprecher+Schuh representative.

④ Other voltages available, see page A56.

⑤ HP selection based on UL508 for Industrial Applications.

⑥ HP selection based on UL/CSA Elevator Duty Ratings.

⑦ See typical Wye-Delta Wiring Diagram on page C117.

# Series CAL7 Lighting Contactors

## Compact contactors for North American lighting applications



Sprecher + Schuh CA7 contactors can be used to control a wide variety of lighting loads. These contactors are well suited to handle the high inrush currents typical of this application as well as other non-motor (resistive) loads.

Lamps can basically be divided into three categories:

- Tungsten Filament Lamps
  - General purpose incandescent
  - Special purpose incandescent
  - Infrared
  - Sodium Iodine
- Discharge Lamps (with Ballast)
  - Fluorescent lamps
  - Mercury vapor
  - High/low pressure sodium
  - Quartz
  - Halogen metal-vapor
- Mixed Light Lamps

### In application...

The tungsten filaments of incandescent lamps have a very low ohmic resistance when cold. As a result, the closing current is very high but also very short.

The closing current of discharge lamps (lighting with ballast) is highly inductive (due to series-connected transformers or chokes), and its duration depends on the lamp type.

In general, North Americans refer to Lighting Contactor ratings in amperes without distinction between incandescent or ballast type of load. The lighting contactor selection table provided on the following page is for North American use, so ratings are selected for mixed lamp loads which account for the higher incandescent inrush.

Europeans usually separate the values for incandescent from discharge (ballast) lighting. Both values are provided in the technical section of our general catalog and may be more appropriate for those applying by CE standards.

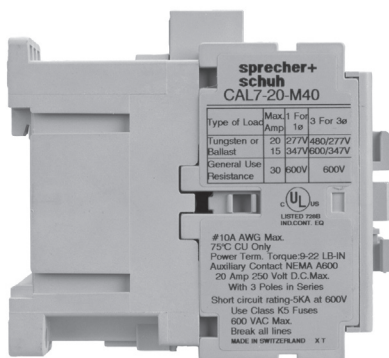

CAL7-20...60 are labeled and UL approved for lighting applications



### Electrically held contactors

Electrically held contactors are available for use where the control signal is activated by a timer or other maintained electrical signal. The coil is energized as long as the contactor is closed. This design is well suited for applications where lights are operated frequently or where the control panel is in a remote location.

### Mechanically held contactors

Mechanically held contactors are available for applications where quiet operation or critical lighting is required, i.e., institutions, hospitals and residential/commercial areas. After the contactor closes, the voltage is disconnected from the operating coil and the contactor is held closed by the mechanical latch. Built-in clearing interlocks allow control from either a momentary or maintained pilot device for the separate “pull-in” and “release” functions.

### Lighting Contactors with AC Coil ④⑤

Type of Load	Continuous Ampere Rating ③	Max. AC Volts, Poles to Load		# of Poles	Standard Auxiliary Contacts		Holding Type	Open Type Catalog Number
		1 for 1Ø	3 for 3Ø		NO	NC		
Tungsten or Ballast General	20	277	480Y/277V	4	0	0	Electrical	<b>CAL7-20-M40-*</b>
	15	347	600Y/347V				Mechanical	<b>CAVL7-20-M40-*-L10 ①</b>
	30	600	600					
Tungsten or Ballast General	30	277	480Y/277V	4	0	0	Electrical	<b>CAL7-30-M40-*</b>
	25	347	600Y/347V				Mechanical	<b>CAVL7-30-M40-*-L10 ①</b>
	37	600	600					
Tungsten or Ballast General	60	277	480Y/277V	4	0	0	Electrical	<b>CAL7-60-M40-*</b>
	55	347	600Y/247V				Mechanical	<b>CAVL7-60-M40-*-L10 ①</b>
	85	600	600					

Larger sizes available. Contact your Sprecher + Schuh representative. See catalog page C44 for enclosed lighting contactors.

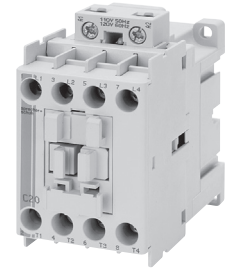

#### Description

The CAL7 electrically held contactors and CAVL7 mechanical held contactors are cUL rated and labeled for tungsten and ballast lighting duty applications at 20, 30, and 60 amperes respectively.

#### Operation of Mechanically Held Contactor with “ON-OFF” Pushbutton

Catalog number “CAVL7” consists of a CAL7 contactor with CV7-11 mechanical latch. Depressing the “ON” button energizes the “L” coil and the contactor closes. The mechanical latch locks the contactor in the closed position. The “L” coil is then de-energized by the coil, clearing contact “UL” (Terminals 65-66) to remove voltage. Depressing the “OFF” button energizes the “UL” coil, and the mechanical latch releases the contactor. The “UL” coil is immediately de-energized by the coil clearing contact “L” (Terminals 13-14) to remove voltage. The contactor is now open.

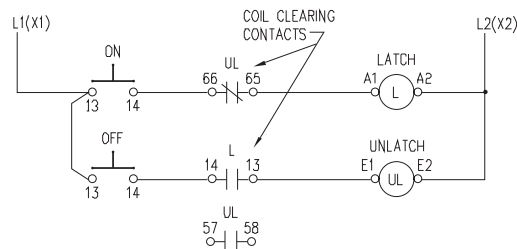

#### CA(L)7 Coil Codes ②







AC Coil Code	Voltage Range	
	50 Hz	60 Hz
24Z	24V	24V
120	110V	120V
220W	200-220V	208-240V
230Z	230V	230V
277	240V	277V
415	400-415V	~
480	440V	480V
600	550V	600V

#### Ordering Instructions

Specify Catalog Number	
Replace (*) with Coil Code	<b>See Coil Codes on this page.</b>

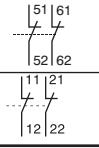
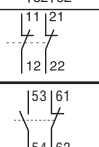
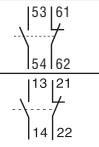
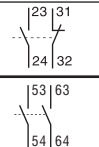
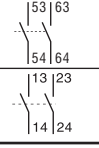
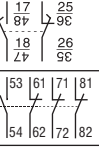
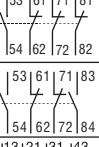
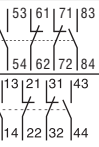
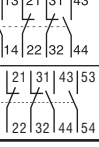
- ① The N.O. auxiliary on the mechanical latch is used by the control circuit and is not available to the customer for other uses.
- ② Other voltages available, see page A56.
- ③ Engineering practice permits  $2.5 \times I_n$  to be applied to a contactor when 3 poles are connected in parallel for single phase discharge lamp (ballast lighting) applications. For example CAL7-20-M40-\* Lighting Contactor plus a CA7-P-B23 Paralleling Link can be used on a 50A ballast load. Applying parallel conductors to incandescent lamp loads does NOT result in a greater permissible load. Paralleling Links can be found in the Accessories section.
- ④ Lighting contactor applications greater than 4-poles can be achieved. Contact Sprecher + Schuh representative for assistance.
- ⑤ Definite Purpose Contactors can also be used in Lighting Contactor applications. See page A183.

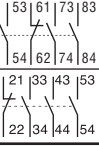
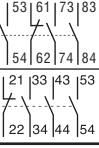
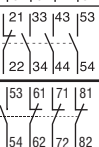
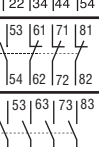
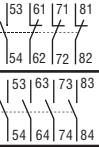
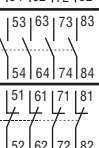
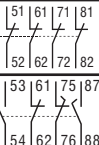











**Top (Front) Mount Auxiliary Contact Blocks ①**

Contact Block	Description	NO	NC	Contact Arrangement	For use with...	Standard Contacts Catalog Number	Bifurcated Contacts Catalog Number ②
 <p>Top mount auxiliary contact blocks snap-on to the top (front) of any CA7 contactor</p>  <p>4-pole auxiliary</p>  <p>2-pole auxiliary contact block (typical)</p>	<p><b>Auxiliary Contact Blocks for Top Mounting -</b></p> <ul style="list-style-type: none"> <li>• 2 and 4 pole</li> <li>• Snap on design - mounts without tools</li> <li>• Electronic compatible contacts</li> <li>• Mutual positive guidance to the main contactor poles (excluding L types)</li> <li>• Several terminal numbering choices even for models wit equal function</li> <li>• Late break /early make (L) available</li> </ul> <p><b>Bifurcated Contacts</b></p> <p>Bifurcated auxiliary contacts provides a higher degree of reliability than the standard cross-stamped auxiliary contacts because it H-bridge divides each movable contact into two sections at the tip of the spanner. Typical application is low-voltage low-current applications (i.e.: PLC). Cross-stamped contacts are good for a minimum of 5mA at 17v while bifurcated contacts are good for a minimum of 3mA at 5v.</p>	0	2		CA7 all	CS7-PV-02	CS7-PVB-02
		1	1		CA7-30...97-*-00	CA7-PV-02	CA7-PVB-02
		1	1		CA7-30...97-*-00	CA7-PV-11	CA7-PVB-11
		2	0		CA7-9...23-*-10	CA7-PV-S11	CA7-PVB-S11
		2	0		CA7-30...97-*-00	CA7-PV-20	CA7-PVB-20
		1EM	1LB		CA7-30...97-*-00	CA7-PV-L11	NOT AVAILABLE
		1	3		CA7-30...97-*-00	NOT AVAILABLE	CA7-PVB-13
		2	2		CA7 all	CS7-PV-22	CS7-PVB-22
		2	2		CA7-30...97-*-00	CA7-PV-22	CA7-PVB-22
		2	2		CA7-9...23-*-10	CA7-PV-S22	CA7-PVB-S22
		2	2		CA7-9...23-*-01	CA7-PV-S22	CA7-PVB-S22
		3	1		CA7 all	CS7-PV-31	CS7-PVB-31
3	1		CA7-9...23-*-10	CA7-PV-S31	CA7-PVB-S31		
3	1		CA7-9...23-*-01	CA7-PV-S31	CA7-PVB-S31		
1	3		CA7 all	CS7-PV-13	CS7-PVB-13		
4	0		CA7 all	CS7-PV-40	CS7-PVB-40		
0	4		CA7 all	CS7-PV-04	CS7-PVB-04		
1+1EM	1+1LB		CA7 all	CS7-PV-L22	NOT AVAILABLE		

① Max. number of auxiliary contacts that may be mounted:  
 • AC Coil and Electronic DC Coil contactors - max. 4 N.O. contacts on the front of the contactor, 2-N.O. contacts on the side, 4-N.C. front or side: 6 total.  
 • True DC Coil contactors - max. 4 N.O. contacts on the front of the contactor, or max. 2-N.O. contacts on side, 4-N.C. front or side: 4 total.  
 ② Detailed ratings can be found on page A75.

#### A Side Mount Auxiliary Contact Blocks (1 & 2 Pole) ①

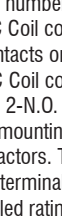





CA7 Contactors

Contact Block	Description	NO	NC	Contact Arrangement	For use with...	Catalog Number ③
 1-pole (typical)	<b>Auxiliary Contact Blocks for Side Mounting - ①</b> <ul style="list-style-type: none"> <li>• 1 and 2-pole</li> <li>• Two way numbering for right or left mounting on the contactor</li> <li>• Snap-on design - mounts without tools</li> <li>• Electronic compatible contacts down to 24V, 20mA</li> <li>• Late break / early make (L) available</li> <li>• Mutual positive guidance to the main contactor poles (excluding L-types)</li> </ul>	0	1		CA7 all	<b>CA7-PA-01</b>
 1-pole (typical)		1	0		CA7 all ②	<b>CA7-PA-10</b>
 2-pole (typical)		0	2		CA7 all	<b>CA7-PA-02</b>
 2-pole (typical)		1	1		CA7 all ②	<b>CA7-PA-11</b>
 2-pole (typical)		2	0		CA7 all ②	<b>CA7-PA-20</b>
 2-pole (typical)		1EM	1LB		CA7 all	<b>CA7-PA-L11</b>

- ① Max. number of auxiliary contacts that may be mounted:
  - AC Coil contactors - max. 4 N.O. contacts on the front of the contactor, 2-N.O. contacts on the side, 4-N.C. front or side: 6 total.
  - DC Coil contactors - max. 4 N.O. contacts on the front of the contactor, or max. 2-N.O. contacts on side, 4-N.C. front or side: (4) total.
- ② Left mounting only is recommended when using with CA7-9...CA7-23 contactors. These contactors have built-in auxiliaries, which will result in duplicate terminal markings if mounted on the right.
- ③ Detailed ratings can be found on page A75.

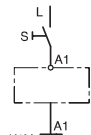
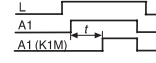
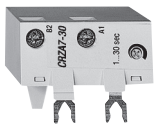
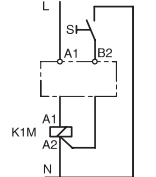
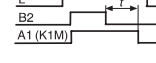
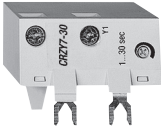
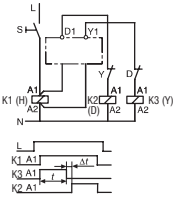
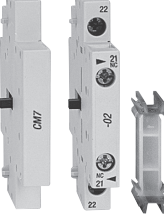

### Control Modules ①

Module	Description	For use with. . .	Connection Diagrams	Function	Catalog Number
	<p><b>Pneumatic Timing Module –</b> The contacts in the Pneumatic Timing Element switch after the delay time. The contacts on the main contactor continue to operate without delay.</p> <ul style="list-style-type: none"> <li>Continuous adjustment range</li> </ul>	CA7 with AC or 24V DC electronic coil		<p><b>ON-Delay</b> 0.3...30s 1.8...180s</p>	<p><b>CZE7-30</b> <b>CZE7-180</b></p>
		CA7 all		<p><b>OFF-Delay</b> 0.3...30s 1.8...180s</p>	<p><b>CZA7-30</b> <b>CZA7-180</b></p>
	<p><b>Electronic Timing Module – ② ON-Delay</b> The contactor is energized at the end of the delay time.</p>	CA7 with 110...240V, 50/60Hz or 110...250V DC		<p>110...240V 50/60Hz 110...250V DC</p> <p>0.1...3s 1...30s 10...180s</p>	<p><b>CRZE7-3-110/240</b> <b>CRZE7-30-110/240</b> <b>CRZE7-180-110/240</b></p>
		CA7 with 24...48V DC		<p>24...48V DC</p> <p>0.1...3s 1...30s 10...180s</p>	<p><b>CRZE7-3-24/48VDC</b> <b>CRZE7-30-24/48VDC</b> <b>CRZE7-180-24/48VDC</b></p>
	<p><b>Electronic Timing Module – ② OFF-Delay</b> After interruption of the control signal, the contactor is de-energized at the end of the delay time.</p>	CA7-9...37 with 110...240V, 50/60Hz		<p>110...240V 50/60Hz</p> <p>0.3...3s 1...30s 10...180s</p>	<p><b>CRZA7-3-110/240</b> <b>CRZA7-30-110/240</b> <b>CRZA7-180-110/240</b></p>
		CA7-9...37 with 24V, 50/60Hz		<p>24V AC 50/60Hz</p> <p>0.3...3s 1...30s 10...180s</p>	<p><b>CRZA7-3-24VAC</b> <b>CRZA7-30-24VAC</b> <b>CRZA7-180-24VAC</b></p>
	<p><b>Electronic Timing Module – ② Wye-Delta Transition Timer</b> Contactor K3 (Y) is de-energized and contactor K2 (D) is energized after the end of the set transition time. Switching delay at 50ms.</p> <ul style="list-style-type: none"> <li>Continuous adjustment range</li> <li>High repeat accuracy</li> </ul>	CA7 with 110...240V, 50/60Hz		<p>110...240V 50/60Hz</p> <p>1...30s</p>	<p><b>CRZY7-30-110/240</b></p>
 <p>CM7 CM7-02</p>	<p><b>Mechanical/Electrical Interlocks –</b></p> <ul style="list-style-type: none"> <li>Common to all CA7 contactors;</li> <li>interlocks different contactor sizes</li> <li>Mechanical and electrical interlocking possible in one module by means of integrated auxiliary contacts</li> <li>Dovetail (CA7-S9) connector included (9mm)</li> </ul>	CA7 all ①		<p><b>Mechanical</b> Without auxiliaries</p>	<p><b>CM7</b></p>
				<p><b>Mechanical/ Electrical</b> Two NC aux contacts</p>	<p><b>CM7-02</b></p>

① Not for use with CA7-40 or CA7-90 (4-pole) contactors.  
② Not available for use on CA7-9E...55E coil voltage 48V...220V.

#### Control Modules (continued)

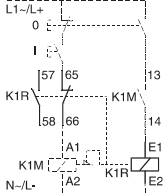
Module	Description	For use with...	Connection Diagrams	Catalog Number
	<p><b>Mechanical Latch –</b> Following contactor latching, the contactor coil is immediately de-energized by the NC auxiliary contact (65-66).</p> <ul style="list-style-type: none"> <li>• Electrical or manual release</li> <li>• 1 NO + 1 NC auxiliary switch</li> <li>• Suitable for all CA7 contactors</li> </ul>	All CA7 ⑥		<p><b>CV7-11-*</b> Replace * with coil code below (See Application Note below)</p>

#### CV7 Mechanical Latch Coil Codes ①②④⑤

Coil Code	Application Range			Latch & Contactor Coil Rating
	50 Hz	60 Hz	VDC	
24Z	24 VAC	24 VAC	12 VDC	24V 50/60 Hz
48Z	48 VAC	48 VAC	24 VDC	48V 50/60 Hz
110	100 VAC	110 VAC	48 or 60VDC	110V50/110V60
120	110 VAC	120 VAC	~	110V50/120V60
220W	~	208...240 VAC	~	208...240V60
230Z	230 VAC	230 VAC	110 VDC	230V 50/60 Hz
240Z	240 VAC	240 VAC	125 VDC	240V 50/60 Hz
277	240 VAC	277 VAC	~	240V50/277V60
380	380...400 VAC	440 VAC	~	380...400V50/440V60
400Z	400 VAC	400 VAC	220 VDC	400V 50/60 Hz
415	400...415 VAC	~	~	400...415 V50 Hz
480	440 VAC	480 VAC	~	440V50/480V60
600 ③	550 VAC	600 VAC	~	550V50/600V60

#### APPLICATION NOTE:

The CV7 Mechanical Latch for CA7 may be used for both AC and DC applications; however when using DC control circuit the user must apply the following rules for coil selection of the contactor and latch combination:

- The CA7-9E...55E contactor uses an electronic DC coil and the CV7 latch coil code should be chosen from the table on the left. (i.e.: 24V DC control circuit select CA7-9E...55E with code 24E and CV7 latch uses a 48Z AC coil code).
- When DC control circuits are required use CA7-60D...97D contactors with standard two winding DC coil and the CV7 latch with AC coil selected from the table, top left. (i.e.: 125V DC control circuit should use 125DD coil code in the contactor and 240Z AC coil code in the CV7 latch).

① Other voltages available. Contact your Sprecher + Schuh representative.

② CV7 must be wired for momentary operation only.





③ Use 600V AC when 575 V is required.

④ Command duration 0.03...10 seconds.

⑥ Coil operating limits on CV7-11 match those of the contactor it is being used with.

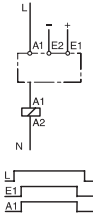

⑦ Not for use with CA7-90 (4-pole) contactors.

Control Modules (continued)

Module	Description	For use with...	Connection Diagrams	Function		Catalog Number
				Input	Output	
	<p><b>Electronic Interface –</b> Interface between the DC control signal from a PLC and the AC operating mechanism of the contactor.</p> <ul style="list-style-type: none"> <li>Requires no additional surge suppression for the coils</li> <li>Suitable for all CA7 contactors ②</li> </ul>	CA7 all (with AC control)		<b>24V DC</b> 12V DC 48V DC	110... 240V AC	<b>CR17E-24</b> <b>CR17E-12</b> <b>CR17E-48</b> <i>Gray is special order</i>
	<p><b>Surge Suppressors -</b> Limits coil switching transients.</p> <ul style="list-style-type: none"> <li>Plug-in, coil mounted</li> <li>Suitable for all CA7 contactors</li> </ul>	CA7 all (with AC control)		<b>RC Module -</b> AC Control (50/60Hz) 24...48V 110...280V 380...480V		<b>CRC7-48</b> <b>CRC7-280</b> <b>CRC7-480</b>
		CA7-9C...43C (with conventional DC control)		<b>Diode Module -</b> DC Control 12-250VDC		<b>CRD7-250</b> ③
		CA7 all (with AC control)  CA7-9C...43C (with conventional DC control)		<b>Varistor Module -</b> AC/DC Control 12...55VAC/ 12...77VDC 56...136VAC/ 78...180VDC 137...277VAC/ 181...350VDC 278...575VAC		<b>CRV7-55</b> ③ <b>CRV7-136</b> ③ <b>CRV7-277</b> ③ <b>CRV7-575</b> ③

- ① Control voltage 18...30V DC (10...15mA)
- ② Minimum actuation current is 5 volts, 2ma. The leakage current is <1mA for the following:
  - CR17E-12 @ 2.5 VDC input
  - CR17E-24 @5 VDC input
  - CR17E-48 @ 10 VDC input.
- ③ Electronic DC Contactors (CA7-9E...55E) include internal surge protection and do not require additional external surge protection.

### AC Voltage Sag Immunity Modules

Module	Description	Full-Wave Bridge Rectifier		Catalog Number
		Module Input	Module Output	
		Control circuit voltage range	For use with CA7-60...97 contactors with DC coil	
	<b>SEMI-F47-Module</b>	24-250 VAC	24-250 VDC ①	<b>CA7-SF47</b>
	<b>Semi-F47-Module with 1...30s on-delay timer</b>	110-250 VAC	110-250 VDC ①	<b>CA7-SF47A30</b>

Sprecher + Schuh's CA7-SF47 module meets the Semi-F47 AC voltage sag immunity requirements to 50% voltage sag for 200 ms. Voltage sags can affect the readiness and operation of contactors and starters, resulting in shut downs, lost production, and diminished revenue. It is essential for process equipment to be compatible with its electrical environment. The CA7-SF47 voltage sag immunity module is an essential component to achieve equipment reliability during voltage sag events.

#### Product Features

- Meets Semi-F47 standard requirements
- For use with CA7-60...97 contactors with DC coils. A full-wave bridge rectifier internal to the CA7-SF47 module provides AC to DC coil voltage rectification.
- Suitable for contactor range (with screw terminals)
  - CA7-60...97, 3-Pole contactors
  - CA7-90, 4-Pole contactor
- Optional 1 to 30 seconds On-Delay timer function.

#### Benefits

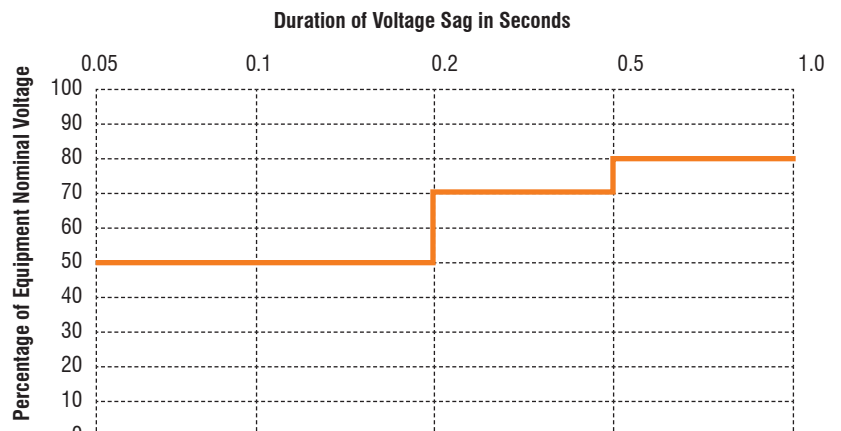

- Direct mounting to the coil terminals of the CA7 contactors. Only 24 mm is added to the component height.
- Direct electrical connection to the contactor. Customer coil power connections are made at the terminals of the CA7-SF47 module
- The CA7-SF47A30 module includes a 1 to 30 seconds adjustable On-Delay timer in addition to the voltage sag immunity functionality. Two independent functions in a single module.



VOLTAGE SAG DURATION				VOLTAGE SAG
Seconds	Milliseconds	Cycles at 60 hz	Cycles at 50 hz	Percent (%) of Equipment Nominal Voltage
< 0.05 s	< 50 ms	< 3 cycles	< 2.5 cycles	Not specified
0.05 to 0.2 s	50 to 200 ms	3 to 12 cycles	2.5 to 10 cycles	50%
0.2 to 0.5 s	200 to 500 ms	12 to 30 cycles	10 to 25 cycles	70%
0.5 to 1.0 s	500 to 1000 ms	30 to 60 cycles	25 to 50 cycles	80%
> 1.0 s	> 1000 ms	> 60 cycles	> 50 cycles	Not specified

① Input AC control circuit voltage must be matched when selecting the contactor/relay DC coil voltage.

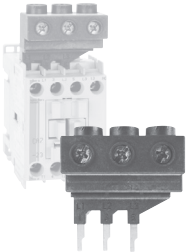
#### Terminal Lug Kits ①

Component	Description	For use with . . .	Maximum Resistive Current Ratings (A) ②			Pkg. Qty.	Catalog Number ①
			IEC (40°C)	IEC (60°C)	UL/CSA (40°C)		
	<b>3 Pole Lug Kit –</b> Allows larger wires to be used with the contactor. Ideal for wye-delta, reversing and multispeed contactors and starters. Can increase IEC AC-1 current rating, as well as the UL/CSA continuous current (resistive) rating of the contactor. Three pole kit used for smaller contactors.	CA7-9. . .23 -line side -load side	45	45	40	1	CA7-P-KN23 CA7-P-KL23
		CA7-30. . .37	60	55	55	1	CA7-P-K37
	<b>1 Pole Lug Kit –</b> Allows larger wires to be used with the contactor. Ideal for wye-delta, reversing and multispeed contactors and starters. Can increase AC-1 current rating of the contactor. One pole kit used for larger contactors.	CA7-43. . .55	90	75	75	3 ③	CA7-P-K43
		CA7-60. . .97	130	130	130	3 ③	CA7-P-K85

#### Paralleling Links ①②

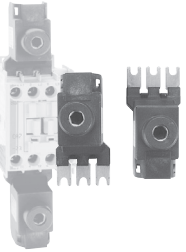
Component	Description	For use with . . .	Maximum Resistive Current Ratings (A) ②			Pkg. Qty.	Catalog Number ①
			IEC (40°C)	IEC (60°C)	UL/CSA (40°C)		
	<b>3 Pole Paralleling Link –</b> Allows smaller CA7 contactors to be used on single-phase resistive applications. By paralleling the three power poles, the contacts see only a portion of the actual load. ④	CA7-9. . .23	100	100	100	2 ③	CA7-P-B23
		CA7-30. . .37	150	135	150	2 ③	CA7-P-B37

#### Quick Connectors

Component	Description	For use with . . .	Pkg. Qty.	Catalog Number
	<b>Stab Connectors -</b> Dual stab (0.250 inch)	CA7-9. . .97 coil term. CA7-9. . .23 power term. CA7 accessories	20 100 100	CA7-SC2 CA7-SC10 CA4-SC11

① cULus Approved (File E33916).

② Lighting applications are not considered purely resistive loads. Therefore, the IEC and UL/CSA resistive ratings listed here do not apply to lighting loads. Lighting contactor ratings are provided in the Technical Information section.

③ Must be ordered in multiples of package quantity. For example on CA7-P-K43, order minimum quantity of 3 for one package of 3 pieces. Price is per piece.

④ Engineering practice permits 2.5 x Ie to be applied to a contactor when 3 poles are connected in parallel for single phase discharge lamp (ballast lighting) applications.

## Reversing Components

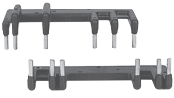
Component	Description	For Use With...	Catalog Number	Pkg. Qty.
	<b>Dovetail Connectors</b> – Connects multiple contactor and starter assemblies together.	CA7 all	<b>CA7-S9</b>	10
	<b>Reversing Power Wiring Kit - ①</b> Provides a solid "wireless" connection for reversing applications. May be used with both solid state and thermal O/L relays.	CA7-9...12 CA7-16...23	<b>CAUT7-PW23</b>	1
		CA7-30...37 CA7-43...55	<b>CAUT7-PW37</b> <b>CAUT7-PW55</b>	1 1
		CA7-60...97	<b>CAUT7-PW85</b>	1

## Reversing Power Wiring Kits

Only the kits are catalog items. Single components are available by special order in bulk packages of 20 pieces.

### Reversing Starter Connection Kits ②

Kit = CAUT7-PW23  
CA7-PWNM23M

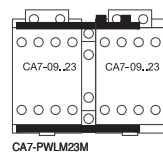

CA7-PWLM23M

Kit = CAUT7-PW37  
CA7-PWNM37M

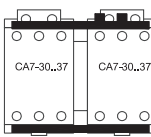

CA7-PWLM37M

Kit = CAUT7-PW55  
CA7-PWN55

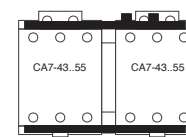

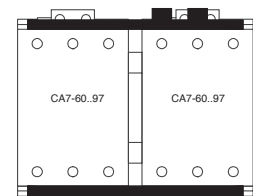

CA7-PWLM55M

Kit = CAUT7-PW85  
CA7-PWNM85M



CA7-PWLM85M

## Assembly Components

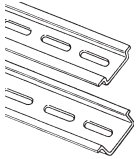
Component	Description	For Use With...	Catalog Number	Pkg. Qty.
	<b>Protective Covers</b> - Protects against unintended manual operation.	CA7 all	<b>CA7-SCC</b>	1
	<b>Protective Covers</b> - For front mounted auxiliary contacts, pneumatic timers and latches.	CS7-PV, CA7-PV, CZE7, CZA7, CV7	<b>CA7-SCF</b>	1
	<b>DIN-rail</b> - 2 meter lengths ( 6' 6"); price per rail  Top Hat, low profile Top Hat, high profile	CA7 all	<b>3F</b>	20
			<b>3AF</b>	10

## Marking Systems

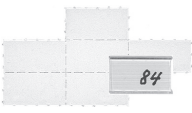
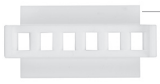
Component	Description	Catalog Number	Pkg. Qty.
	<b>Label Sheet</b> – 1 sheet with 105 self-adhesive paper labels, each 6 x 17mm	<b>CA7-FMS</b>	1
	<b>Marking Tag Sheet</b> - 1 sheet with 160 perforated paper labels each, 6 x 17mm. To be used with transparent cover.	<b>CA7-FMP</b>	1
		<b>Transparent Cover</b> - To be used with Marking Tag Sheets.	<b>CA7-FMC</b>
	<b>Tag Carrier</b> - For marking with marker cards and tags. See page N35 for complete listing of available cards and tabs.	<b>CA7-FMA2</b>	100 ②

① cULus Approved (File E33916).

② Minimum quantity is one package of 100. Price is each x 100 = package price.

### Wye-Delta Starter Kits ①

Wye-Delta power wiring kits were designed to aid in the field assembly of open-transition wye-delta starters that use CA7 contactors. These kits include line, load and start-point (shorting) connections. Assembling a wye-delta starter requires the use of the following components:

- Contactors and overload relay
- Mechanical / Electrical Interlock (Cat.No: CM7-02)
- Electronic Wye-delta Timer (Cat. No: CRZY7-30-110/240)
- Dovetail Connector to couple 1M and 2M contactor (Cat. No: CA7-S9); optional



Power Jumper Connection



Shorting Bar



Reversing Power Connection

### Three Contactor Assembly Components

3-Phase Rating										For 3 contactor assembly ②	
kW (50Hz)				HP (60Hz)				Use with catalog number . . .			
230V	380V 415V	500V	690V	200V	230V	460V	575V	Delta	Wye		
								1M	2M	1S	<b>Catalog Number</b>
5.5	8	8	8	5	5	10	10	CA7-9	CA7-9	CA7-9	<b>CAYT7-PW23</b>
7.5	11	11	11	5	7.5	15	15	CA7-12	CA7-12	CA7-9	
10	14	15	14	7.5	10	20	20	CA7-16	CA7-16	CA7-12	
14	21	21	19	7.5	10	25	25	CA7-23	CA7-23	CA7-12	
18	28	28	28	10	15	30	30	CA7-30	CA7-30	CA7-16	<b>CAYT7-PW37</b>
19	35	35	32	15	20	40	40	CA7-37	CA7-37	CA7-23	
23	40	40	41	20	25	50	50	CA7-43	CA7-43	CA7-30	<b>CAYT7-PW55</b>
30	45	45	45	25	30	60	60	CA7-55	CA7-55	CA7-37	
33	58	60	56	30	40	75	75	CA7-60	CA7-60	CA7-37	<b>CAYT7-PW72</b>
39	69	67	70	40	50	100	100	CA7-72	CA7-72	CA7-43	
47	82	82	81	50	60	125	125	CA7-85	CA7-85	CA7-60	<b>CAYT7-PW85</b>
50	90	90	90	50	60	125	125	CA7-97	CA7-97	CA7-60	

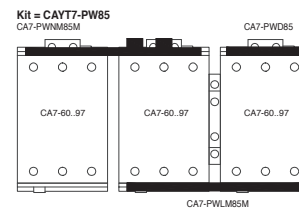
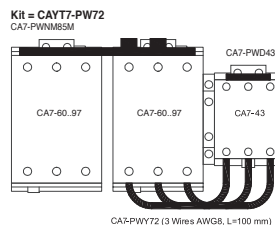
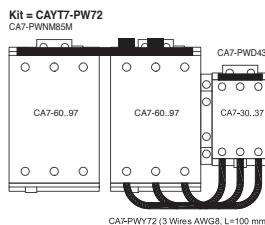
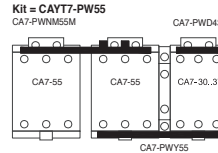
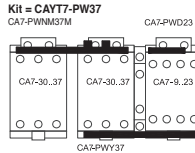
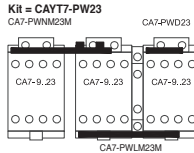

### Two Contactor Assembly Components

When Connecting...		Load Side Power Connection	Shorting Bar
Delta	Wye		
2M	1S	<b>Catalog Number</b>	<b>Catalog Number</b>
CA7-30	CA7-30	<b>CA7-PWLM37M</b>	<b>CA7-PWD43</b>
CA7-37	CA7-37		
CA7-43	CA7-43	<b>CA7-PWLM55M</b>	<b>CA7-PWD43</b>
CA7-55	CA7-55		
CA7-60	CA7-60	<b>CA7-PWLM85M</b>	<b>CA7-PWD85</b>
CA7-72	CA7-72		
CA7-85	CA7-85		
CA7-97	CA7-97		

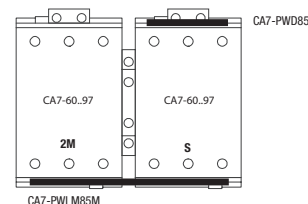
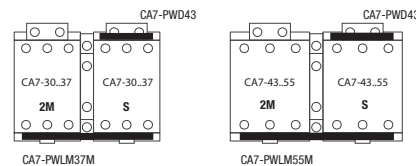

Two Contactor Wiring Connections are for Hydraulic Elevator Wye-Delta Contactors CA7Y2

① cULus Approved (File E33916).

② Individual parts of kits are available for unique applications by special order. Contact your Sprecher + Schuh Representative.

#### Renewal Coils - A.C. ①

AC Control Voltages			AC Coil Codes	For use with contactor . . .				
				CA7-9...16 CA7-9-M...16-M... CAQ7-16 CNX-205...206 CAN7-12...16 ~	CA7-23...37 CA7-23-M...37-M... CAQ7-37 CNX-207...209 CAN7-37 CAL(V)7-20-M40	CA7-43...55 ~ ~ CA7-40-M, CAN7-43 CAL(V)7-30-M40	CA7-60...85 ~ ~ CNX-212 CNX-218 CAN7-85 ~	CA7-97 CA7-90-M... ~ ~ CAL(V)7-60-M40
50 Hz	60 Hz	50/60 Hz	Cat. No.	Cat. No.	Cat. No.	Cat. No.	Cat. No.	
~	~	24V	<b>24Z</b>	<b>TA855</b>	<b>TC855</b>	<b>TD855</b>	<b>TE855</b>	<b>TF855</b>
32V	36V	~	36	~	~	~	<b>TE481</b>	~
48V	~	~	48A	~	<b>TC414</b>	<b>TD414</b>	~	~
110V	120V	~	<b>120</b>	<b>TA473</b>	<b>TC473</b>	<b>TD473</b>	<b>TE473</b>	<b>TF473</b>
115V	127V	~	127	<b>TA424</b>	<b>TC424</b>	~	~	~
200...220V	208.. 240V	~	<b>220W</b>	<b>TA296</b>	<b>TC296</b>	<b>TD296</b>	<b>TE296</b>	<b>TF296</b>
~	~	230V	230Z	<b>TA851</b>	<b>TC851</b>	<b>TD851</b>	<b>TE851</b>	<b>TF851</b>
240V	277V	~	<b>277</b>	<b>TA480</b>	<b>TC480</b>	<b>TD480</b>	<b>TE480</b>	<b>TF480</b>
400...415V	~	~	415	<b>TA457</b>	<b>TC457</b>	<b>TD457</b>	<b>TE457</b>	<b>TF457</b>
440V	480V	~	<b>480</b>	<b>TA475</b>	<b>TC475</b>	<b>TD475</b>	<b>TE475</b>	<b>TF475</b>
550V	600V	~	<b>600</b>	<b>TA476</b>	<b>TC476</b>	<b>TD476</b>	<b>TE476</b>	<b>TF476</b>

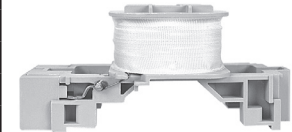

CA7 AC Coil (typical)

① AC Codes in bold letters and shaded indicate coils that are standard stocked items.



#### Renewal Coils - D.C. ①

DC Control Voltages	DC Coil Codes ①	Electronic DC Replacement Coils ④				Two Winding DC Replacement Coils	
		For use with contactor...				For use with contactor...	
		CA7-9E...16E CA7-9E-M...16E-M... CAN7-12E...16E	CA7-23E...37E CA7-23E-M... CAN7-37E	CA7-43E...55E CA7-40E-M... CAN7-43E (Series A)	CA7-43E...55E CA7-40E-M... CAN7-43E (Series B)	CA7-60D...85D ③ CNX7-218 CAN7-85D	CA7-97D ③ CA7-90D-M...
Cat. No.	Cat. No.	Cat. No.	Cat. No.	Cat. No.	Cat. No.		
		CA7-	CA7-	CA7-	CA7-	CA7-	CA7-
12V Electronic	<b>12E</b>	<b>TC708E</b>	<b>TC708E</b>	~	<b>TD708E2</b>	~	~
24V Electronic	<b>24E</b>	<b>TC714E</b>	<b>TC714E</b>	~	<b>TD714E2</b>	~	~
24V Diode ②	<b>24DD</b>	~	~	~	~	<b>TE714M</b>	<b>TF714M</b>
36-48V Elec	<b>36E</b>	<b>TC719E</b>	<b>TC719E</b>	~	<b>TD719E2</b>	~	~
48-72V Elec	<b>48E</b>	<b>TC724E</b>	<b>TC724E</b>	~	<b>TD724E2</b>	~	~
64V Diode	<b>64DD</b>	~	~	~	~	~	<b>TF727M</b>
72V Diode	<b>72DD</b>	~	~	~	~	<b>TE728M</b>	<b>TF728M</b>
110-125V Elec	<b>110E</b>	<b>TC733E</b>	<b>TC733E</b>	~	<b>TD733E2</b>	~	~
110V Diode	<b>110DD</b>	~	~	~	~	<b>TE733M</b>	<b>TF733M</b>
220-250V Elec	<b>220E</b>	<b>TC747E</b>	<b>TC747E</b>	~	<b>TD747E2</b>	~	~

**Note:** The “DD” coils listed above include an integrated bidirectional diode. Drop out time of this design is significantly improved when compared to an external diode. See ratings on page A69.

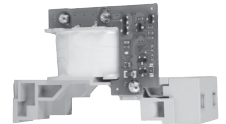

12V & 24V Electronic DC coil

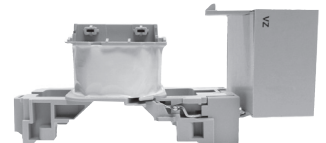

36V...220V Electronic DC coil with Back Pack



Two Winding DC coil (typical) ③

- ① DC Codes in bold letters and shaded indicate coils that are standard stocked items.
- ② Voltage operating range: 0.7...1.25 x Us.
- ③ CA7-60D...97D contactors have a two winding coil with built-in late break auxiliary contact and coil suppression.
- ④ CA7-9E...55E electronic coils are not interchangeable with non-electronic DC or AC coils

#### Replacement Contactors Cross Reference, Series CA1 to Series CA7 (Open Type Only) ①

$I_e$ [A]		Ratings for Switching AC Motors (AC2 / AC3 / AC4)										Series CA1U Obsolete	Series CA7 Equivalent
		kW (50 Hz)				UL/CSA HP (60 Hz)							
		AC-3	AC-1	230V	400V / 415V	500V	690V	1 Ø		3 Ø			
115V	230V							200V	230V	460V	575V		
						1	3	5	5	10	10	CA1U-10	
16	32	5.5	7.5	7.5	7.5	1	3	5	5	10	15		CA7-16-10
						2	3	7-1/2	7-1/2	15	20	CA1U-14	
23	32	7.5	11	13	10	2	3	5	7-1/2	15	15		CA7-23-10
						2	5	7-1/2	10	20	25	CA1U-16	
30	65	10	15	15	15	2	5	7-1/2	10	20	25		CA7-30-10
						3	7-1/2	10	15	30	40	CA1U-25	
43	85	13	22	25	22	3	7-1/2	10	15	30	30		CA7-43-10
72	100	22	40	45	40	5	15	20	25	50	60		CA7-72-10
						5	15	25	25	50	60	CA1U-40	
85	100	25	45	55	45	7-1/2	15	25	30	60	60		CA7-85-10
						7-1/2	20	30	30	60	75	CA1U-55	
97	130	30	55	55	55	10	15	30	30	75	75		CA7-97-10

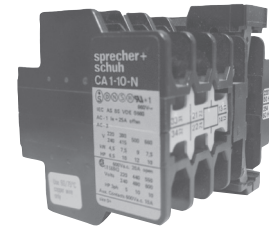

CA1U-10  
Contactor

#### Replacement Contactors Cross Reference, Series CA3 to Series CA7 (Open Type Only) ①

$I_e$ [A]		Ratings for Switching AC Motors (AC2 / AC3 / AC4)										Series CA3 Obsolete	Series CA7 Equivalent
		kW (50 Hz)				UL/CSA HP (60 Hz)							
		AC-3	AC-1	230V	400V / 415V	500V	690V	1 Ø		3 Ø			
115V	230V							200V	230V	460V	575V		
								2	2	5	7-1/2	CA3-9-10	
9	32	3	4	4	4	1/2	1 1/2	2	2	5	7-1/2		CA7-9-10
								3	3	7-1/2	10	CA3-12-10	
12	32	4	5.5	5.5	5.5	1/2	2	3	3	7-1/2	10		CA7-12-10
								5	5	10	15	CA3-16-10	
16	32	5.5	7.5	7.5	7.5	1	3	5	5	10	15		CA7-16-10
								5	5	10	15	CA3-23A-10	
23	32	7.5	11	13	10	2	3	5	7-1/2	15	15		CA7-23-10
								7-1/2	7-1/2	15	20	CA3-23-10	
30	65	10	15	15	15	2	5	7-1/2	10	20	25		CA7-30-10
								10	10	20	25	CA3-30-10	
								10	10	25	30		CA7-37-10
37	65	11	18.5/20	20	18.5	3	5	10	10	25	30	CA3-37	
43	85	13	22	25	22	3	7-1/2	10	15	30	30		CA7-43-10
								10	15	30	40	CA3-43	
								15	20	40	50	CA3-60	
55	85	15	30	30	22	5	10	15	20	40	40		CA7-55-10
60	100	18.5	32	37	32	5	10	15	20	40	50		CA7-60-10
								20	20	50	60	CA3-72	
72	100	22	40	45	40	5	15	20	25	50	60		CA7-72-10
85	100	25	45	55	45	7-1/2	15	25	30	60	60		CA7-85-10
97	130	30	55	55	55	10	15	30	30	75	75		CA7-97-10

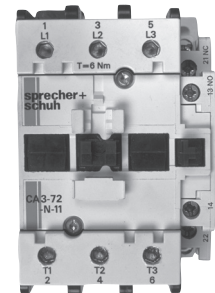

CA3-72  
Contactor

① Available auxiliary contacts may vary. See selection pages for more information.

**Electrical Data**

			CA7-9	CA7-12	CA7-16	CA7-23	CA7-30	CA7-37	CA7-43	CA7-55	CA7-60	CA7-72	CA7-85	CA7-97
<b>Rated Insulation Voltage <math>U_i</math></b>	IEC, AS,BS,SEV, VDE 0660	[V]												
	UL; CSA	[V]							690V					
<b>Rated Impulse Voltage <math>U_{imp}</math></b>		[kV]							600V					
<b>Rated Voltage <math>U_e</math>-Main Contacts</b>	AC 50/60Hz	[V]				115, 200, 208, 230, 240, 380, 400, 415, 460, 500, 575, 690V								
	DC	[V]				24, 48, 110, 115, 220, 230, 300, 440V								
<b>Operating Frequency for AC Loads</b>		[Hz]	50...60Hz											
<b>Switching Motor Loads</b>														
<b>Standard IEC Ratings</b>														
<b>AC-2, AC-3, AC-4</b>														
	230V	[A]	12	15	20	26.5	35	38	44	56	62	72	85	96
	240V	[A]	12	15	20	26.5	35	38	44	56	62	72	85	95
	400V	[A]	9	12	16	23	30	37	43	55	60	72	85	97
	415V	[A]	9	12	16	23	30	37	43	55	60	72	85	97
	500V	[A]	7	10	14	20	25	30	38	44	55	67	80	78
	690V	[A]	5	7	9	12	18	21	25	25	34	42	49	57
	230V	[kW]	3	4	5.5	7.5	10	11	13	15	18.5	22	25	30
	240V	[kW]	3	4	5.5	7.5	10	11	13	15	18.5	22	25	30
	400V	[kW]	4	5.5	7.5	11	15	18.5	22	30	32	40	45	55
	415V	[kW]	4	5.5	7.5	11	15	20	22	30	32	40	45	55
	500V	[kW]	4	5.5	7.5	13	15	20	25	30	37	45	55	55
	690V	[kW]	4	5.5	7.5	10	15	18.5	22	22	32	40	45	55
<b>UL/CSA</b>														
	115V	[A]	9.8	9.8	16	24	24	34	34	56	56	56	80	100
	230V	[A]	10	12	17	17	28	28	40	50	50	68	68	88
	115V	[HP]	1/2	1/2	1	2	2	3	3	5	5	5	7-1/2	10
	230V	[HP]	1 1/2	2	3	3	5	5	7-1/2	10	10	15	15	20
	200V	[A]	7.8	11	17.5	17.5	25.3	32.2	32.2	48.3	48.3	62.1	78.2	92
	230V	[A]	6.8	9.6	15.2	22	28	28	42	54	54	68	80	80
	460V	[A]	7.6	11	14	21	27	34	40	52	52	65	77	96
	575V	[A]	9	11	17	17	27	32	32	41	52	62	62	77
	200V	[HP]	2	3	5	5	7-1/2	10	10	15	15	20	25	30
	230V	[HP]	2	3	5	7-1/2	10	10	15	20	20	25	30	30
	460V	[HP]	5	7-1/2	10	15	20	25	30	40	40	50	60	75
	575V	[HP]	7-1/2	10	15	15	25	30	30	40	50	60	60	75
<b>Maximum Operating Rate (at max. amps) ❶</b>	AC2	[ops/hr]	450	450	450	400	400	400	400	400	300	300	200	200
	AC3	[ops/hr]	700	700	700	600	600	600	600	600	500	500	500	500
	AC4	[ops/hr]	200	150	120	80	80	70	70	70	70	60	50	50

❶ See page A82 for additional detail.

**A**

**Electrical Data**

**CA7 Contactors**

			CA7-9	CA7-12	CA7-16	CA7-23	CA7-30	CA7-37	CA7-43	CA7-55	CA7-60	CA7-72	CA7-85	CA7-97		
<b>Switching Motor Loads</b> (continued)																
<b>AC-4</b> 200,000 Op. Cycles 50Hz	230V	[A]	4.3	6.6	9	9	12	14	16.5	22	25.5	31	38	44		
	240V	[A]	4.3	6.6	9	9	12	14	16.5	22	25.5	31	38	44		
	400V	[A]	4.3	6.6	9	9	12	14	16.5	22	25.5	31	38	44		
	415V	[A]	4.3	6.6	9	9	12	14	16.5	22	25.5	31	38	44		
	500V	[A]	4.3	6.6	9	9	12	14	16.5	22	25.5	31	38	44		
	690V	[A]	4.3	6.6	9	9	12	14	16.5	22	25.5	31	38	44		
	230V	[kW]	0.75	1.5	2.2	2.2	3	3.7	4	5.5	6.3	7.5	11	11		
	240V	[kW]	0.75	1.5	2.2	2.2	3	4	4	5.5	7.5	7.5	11	11		
	400V	[kW]	1.8	3	4	4	5.5	6.3	7.5	11	13	15	20	22		
	415V	[kW]	1.8	3	4	4	5.5	6.3	7.5	11	13	17	20	22		
	500V	[kW]	2.2	3.7	5.5	5.5	7.5	7.5	10	11	15	20	25	30		
	690V	[kW]	3	5.5	7.5	7.5	10	11	15	18.5	22	25	32	37		
	60Hz	1Ø	115V	[A]	4.3	6.6	9	10	12	14	16.5	22	25.5	31	38	44
			230V	[A]	4.3	6.6	9	10	12	14	16.5	22	25.5	31	38	44
115V			[HP]	1/8	1/4	1/3	1/2	1/2	3/4	1	1.5	2	2	3	3	
230V			[HP]	1/3	1/2	1	1-1/2	2	2	2	3	3	5	5	7-1/2	
3Ø		200V	[A]	4.3	6.6	9	10	12	14	16.5	22	25.5	31	38	44	
		230V	[A]	4.3	6.6	9	10	12	14	16.5	22	25.5	31	38	44	
		460V	[A]	4.3	6.6	9	10	12	14	16.5	22	25.5	31	38	44	
		575V	[A]	4.3	6.6	9	10	12	14	16.5	22	25.5	31	38	44	
		200V	[HP]	3/4	1	2	2	3	3	3	5	7-1/2	7-1/2	10	10	
		230V	[HP]	1	1-1/2	2	3	3	3	5	7-1/2	7-1/2	10	10	15	
		460V	[HP]	2	3	5	5	7-1/2	10	10	15	15	20	25	30	
		575V	[HP]	3	5	7-1/2	7-1/2	10	10	10	20	20	25	30	40	
		Maximum Operating Rate	[ops/hour]	250	250	220	200	200	200	200	200	200	120	120	120	120
		<b>Wye-Delta (Star Delta)</b> 50 Hz	230V	[kW]	5.5	7.5	10	13	17	20	22	30	32	37	45	50
240V	[kW]		5.5	7.5	10	13	18.5	20	22	30	32	40	50	50		
400V	[kW]		7.5	10	13	20	25	32	40	45	55	63	80	90		
415V	[kW]		7.5	11	15	22	25	37	40	45	55	63	80	90		
500V	[kW]		7.5	11	15	22	25	32	45	45	63	80	90	90		
690V	[kW]		7.5	10	13	18.5	25	32	40	45	55	63	80	90		
60 Hz	200V	[HP]	5	5	7-1/2	7-1/2	10	15	20	25	30	40	50	50		
	230V	[HP]	5	7-1/2	10	10	15	20	25	30	40	50	60	60		
	460V	[HP]	10	15	20	25	30	40	50	60	75	100	125	125		
	575V	[HP]	10	15	20	25	30	40	50	60	75	100	125	125		
<b>UL/CSA Elevator Duty</b>	200V	[A]	7.8	11.0	11.0	17.5	25.3	25.3	32.2	30.8	32.2	48.3	62.1	78.2		
	230V	[A]	6.8	9.6	15.2	15.2	22.0	28.0	28.0	42.0	42.0	54.0	68.0	80.0		
	460V	[A]	7.6	11.0	14.0	21.0	27.0	27.0	34.0	40.0	40.0	52.0	65.0	77.0		
	575V	[A]	6.1	9.0	11.0	17.0	22.0	27.0	32.0	41.0	41.0	52.0	62.0	77.0		
	200V	[HP]	2	3	3	5	7-1/2	7-1/2	10	10	10	15	20	25		
	230V	[HP]	2	3	5	5	7-1/2	10	10	15	15	20	25	30		
	460V	[HP]	5	7-1/2	10	15	20	20	25	30	30	40	50	60		
	575V	[HP]	5	7-1/2	10	15	20	25	30	40	40	50	60	75		

**Electrical Data**

			CA7-9	CA7-12	CA7-16	CA7-23	CA7-30	CA7-37	CA7-43	CA7-55	CA7-60	CA7-72	CA7-85	CA7-97	
<b>AC-1 Load, 3Ø Switching</b> Ambient Temperature 40° C	$I_{th}$	[A]	32	32	32	32	65	65	85	85	100	100	100	130	
	230V	[kW]	13	13	13	13	26	26	34	34	40	40	40	52	
	240V	[kW]	13	13	13	13	27	27	35	35	42	42	42	54	
	400V	[kW]	22	22	22	22	45	45	59	59	69	69	69	90	
	415V	[kW]	23	23	23	23	47	47	61	61	72	72	72	93	
	500V	[kW]	28	28	28	28	56	56	74	74	87	87	87	113	
	690V	[kW]	38	38	38	38	78	78	102	102	120	120	120	155	
Ambient Temperature 60° C	$I_{th}$	[A]	32	32	32	32	65	65	75	75	100	100	100	110	
	230V	[kW]	13	13	13	13	26	26	25	25	40	40	40	44	
	240V	[kW]	13	13	13	13	27	27	26	26	42	42	42	46	
	400V	[kW]	22	22	22	22	45	45	44	44	69	69	69	76	
	415V	[kW]	23	23	23	23	47	47	45	45	72	72	72	76	
	500V	[kW]	28	28	28	28	56	56	55	55	87	87	87	95	
	690V	[kW]	38	38	38	38	78	78	75	75	120	120	120	131	
Maximum Operating Rate		[ops/hour]	1,000	1,000	1,000	1,000	1,000	1,000	300	300	600	600	600	600	
<b>Continuous Current (UL/CSA)</b> General Purpose Rating (40°)	Open	[A]	25	25	30	30	55	60	75	75	90	90	100	120	
	Enclosed	[A]	25	25	30	30	55	60	75	75	90	90	100	120	
	Maximum Operating Rate		[ops/hour]	1,400	1,400	1,200	1,200	1,200	1,000	1000	1000	700	700	600	600
<b>Lighting Loads ①</b> Elec. Dischrg. Lamps-AC-5a, single compensated	Open	[A]	22.5	25	28	29	40.5	45	77	77	81	85	90	115	
	Enclosed	[A]	22.5	25	28	29	37	41	57	57	77	81	90	100	
	Max. capacitance at prospective short circuit current available at the contactor	10kA	[mf]	1,000	1,000	1,000	1,000	2,700	2,700	3,200	3,200	4,000	4,000	4,700	4,700
		20kA	[µf]	500	500	500	500	1,350	1,350	1,600	1,600	2,000	2,000	2,350	2,350
		50kA	[µf]	200	200	200	200	540	540	640	640	800	800	940	940
	Incandescent Lamps - AC -5b Electrical endurance ~ 100,000 operations		[A]	12	16	18	22	30	37	43	51	60	70	76	90
<b>Switching power transformers AC-6a 50Hz</b>															
Inrush	= n														
Rated transformer current		[A]	10.9	10.9	10.9	10.9	20	20	23	23	40.8	40.8	40.8	48.5	
n=30	230 VAC	[kVA]	4.3	4.3	4.3	4.3	8	8	9.2	9.2	16	16	16	19.3	
	240 VAC	[kVA]	4.5	4.5	4.5	4.5	8.3	8.3	10	10	17	17	17	20.2	
	380 VAC	[kVA]	7.2	7.2	7.2	7.2	13.2	13.2	15.4	15.4	26.9	26.9	26.9	31.9	
	400 VAC	[kVA]	7.5	7.5	7.5	7.5	14	14	16	16	28	28	28	33.6	
	415 VAC	[kVA]	7.8	7.8	7.8	7.8	14	14	17	17	29	29	29	34.9	
	500 VAC	[kVA]	9.4	9.4	9.4	9.4	17	17	20	20	35	35	35	42	
	690 VAC	[kVA]	13	13	13	13	24	24	27	27	49	49	49	58	
n=20		[A]	16.3	16.3	16.3	16.3	30	30	34.5	34.5	61.3	61.3	61.3	72.8	
	230 VAC	[kVA]	6.5	6.5	6.5	6.5	12	12	14	14	24.4	24.4	24.4	29.0	
	240 VAC	[kVA]	6.8	6.8	6.8	6.8	12.5	12.5	14.6	14.6	25.5	25.5	25.5	30.3	
	380 VAC	[kVA]	10.7	10.7	10.7	10.7	19.7	19.7	23.2	23.2	40.3	40.3	40.3	47.9	
	400 VAC	[kVA]	11.3	11.3	11.3	11.3	20.8	20.8	24.4	24.4	42.5	42.5	42.5	50.4	
	415 VAC	[kVA]	11.7	11.7	11.7	11.7	21.6	21.6	25.3	25.3	44.1	44.1	44.1	52.3	
	500 VAC	[kVA]	14.1	14.1	14.1	14.1	26	26	30.5	30.5	53.1	53.1	53.1	63.0	
690 VAC	[kVA]	19.5	19.5	19.5	19.5	35.9	35.9	42.1	42.1	73.3	73.3	73.3	86.9		
n=15		[A]	21.7	21.7	21.7	21.7	40	40	46	46	81.7	81.7	81.7	97.0	
	230 VAC	[kVA]	8.7	8.7	8.7	8.7	15.9	15.9	18.7	18.7	32.5	32.5	32.5	38.6	
	240 VAC	[kVA]	9	9	9	9	16.6	16.6	19.5	19.5	33.9	33.9	33.9	40.3	
	380 VAC	[kVA]	14.3	14.3	14.3	14.3	26.3	26.3	30.9	30.9	53.8	53.8	53.8	63.8	
	400 VAC	[kVA]	15.1	15.1	15.1	15.1	27.7	27.7	32.5	32.5	56.6	56.6	56.6	67.2	
	415 VAC	[kVA]	15.6	15.6	15.6	15.6	28.8	28.8	33.7	33.7	58.7	58.7	58.7	69.7	
	500 VAC	[kVA]	18.8	18.8	18.8	18.8	34.6	34.6	40.6	40.6	70.7	70.7	70.7	84.0	
690 VAC	[kVA]	26	26	26	26	47.8	47.8	56.1	56.1	97.6	97.6	97.6	115.9		

① CA7 ratings for lighting loads are provided for technical reference. For cUL rated and labeled devices, see CAL7 contactors listed in this section.

**Electrical Data**

AC-6a		CA7-9	CA7-12	CA7-16	CA7-23	CA7-30	CA7-37	CA7-43	CA7-55	CA7-60	CA7-72	CA7-85	CA7-97
<b>Switching power transformers - 60Hz</b>													
Inrush = n													
n=30	Rated transformer current [A]	10.9	10.9	10.9	10.9	20	20	23	23	40.8	40.8	40.8	48.5
	200 VAC [kVA]	3.8	3.8	3.8	3.8	6.9	6.9	8.0	8.0	14.1	14.1	14.1	16.8
	208 VAC [kVA]	3.9	3.9	3.9	3.9	7.2	7.2	8.3	8.3	14.7	14.7	14.7	17.5
	240 VAC [kVA]	4.5	4.5	4.5	4.5	8.3	8.3	9.6	9.6	17	17	17	20.2
	480 VAC [kVA]	9.1	9.1	9.1	9.1	16.6	16.6	19.1	19.1	33.9	33.9	33.9	40.3
	600 VAC [kVA]	11.3	11.3	11.3	11.3	20.8	20.8	23.9	23.9	42.4	42.4	42.4	50.4
	660 VAC [kVA]	12.5	12.5	12.5	12.5	22.9	22.9	26.3	26.3	46.6	46.6	46.6	55.4
n=20	[A]	16.3	16.3	16.3	16.3	30	30	34.5	34.5	61.3	61.3	61.3	72.8
	200 VAC [kVA]	5.6	5.6	5.6	5.6	10.4	10.4	12	12	21.2	21.2	21.2	25.2
	208 VAC [kVA]	5.9	5.9	5.9	5.9	10.8	10.8	12.4	12.4	22.1	22.1	22.1	26.2
	240 VAC [kVA]	6.8	6.8	6.8	6.8	12.5	12.5	14.3	14.3	25.5	25.5	25.5	30.3
	480 VAC [kVA]	13.6	13.6	13.6	13.6	24.9	24.9	28.7	28.7	51	51	51	60.5
	600 VAC [kVA]	16.9	16.9	16.9	16.9	31.2	31.2	35.9	35.9	63.7	63.7	63.7	75.7
	660 VAC [kVA]	18.6	18.6	18.6	18.6	34.3	34.3	39.4	39.4	70.1	70.1	70.1	83.2
n=15	[A]	22	22	22	22	40	40	46	46	82	82	82	97
	200 VAC [kVA]	7.5	7.5	7.5	7.5	13.9	13.9	15.9	15.9	28.4	28.4	28.4	33.6
	208 VAC [kVA]	7.8	7.8	7.8	7.8	14.4	14.4	16.6	16.6	29.5	29.5	29.5	34.9
	240 VAC [kVA]	9	9	9	9	16.6	16.6	19.1	19.1	34.1	34.1	34.1	40.3
	480 VAC [kVA]	18.1	18.1	18.1	18.1	33.3	33.3	38.2	38.2	68.2	68.2	68.2	80.6
	600 VAC [kVA]	22.6	22.6	22.6	22.6	41.6	41.6	47.8	47.8	85.2	85.2	85.2	100.8
	660 VAC [kVA]	24.9	24.9	24.9	24.9	45.7	45.7	52.6	52.6	93.7	93.7	93.7	110.9
<b>AC-6b ①</b>													
<b>Capacitor Switching - 50Hz</b>													
Single Capacitor - 40°C													
230 VAC [kVar]	8	8	8.5	9	14	14	24	24	28	28	28	28	28
240 VAC [kVar]	8	8	8.5	9	14	14	25	25	29	29	29	29	29
400 VAC [kVar]	8	8	10	12.5	20	24	35	35	48	48	48	48	48
415 VAC [kVar]	8	8	10	12.5	20	25	35	35	50	50	50	50	50
500 VAC [kVar]	8	8	10	12.5	20	25	35	35	50	55	60	60	60
690 VAC [kVar]	8	8	10	12.5	20	25	35	35	50	55	60	60	60
Single Capacitor - 60°C													
230 VAC [kVar]	8	8	8.5	9	12.5	12.5	18	18	28	28	28	28	28
240 VAC [kVar]	8	8	8.5	9	12.5	12.5	18	18	29	29	29	29	29
400 VAC [kVar]	8	8	10	12.5	20	21.5	30	30	42	48	48	48	48
415 VAC [kVar]	8	8	10	12.5	20	22	30	30	42	50	50	50	50
500 VAC [kVar]	8	8	10	12.5	20	25	30	30	42	50	55	55	55
690 VAC [kVar]	8	8	10	12.5	20	25	30	30	42	50	55	55	55
Capacitor Bank - 40°C													
230 VAC [kVar]	5	5	8	9	12.5	14	20	20	28	28	28	28	28
240 VAC [kVar]	5	5	8	9	12.5	14	20	20	29	29	29	29	29
400 VAC [kVar]	5	5	8	10	15	20	25	25	40	48	48	48	48
415 VAC [kVar]	5	5	8	10	15	20	25	25	40	50	50	50	50
500 VAC [kVar]	5	5	8	10	15	20	25	25	40	50	50	50	50
690 VAC [kVar]	5	5	8	10	15	20	25	25	40	50	50	50	50
Capacitor Bank - 60°C													
230 VAC [kVar]	5	5	8	9	12.5	12.5	18	18	28	28	28	28	28
240 VAC [kVar]	5	5	8	9	12.5	12.5	18	18	29	29	29	29	29
400 VAC [kVar]	5	5	8	10	15	20	25	25	40	48	48	48	48
415 VAC [kVar]	5	5	8	10	15	20	25	25	40	50	50	50	50
500 VAC [kVar]	5	5	8	10	15	20	25	25	40	50	50	50	50
690 VAC [kVar]	5	5	8	10	15	20	25	25	40	50	50	50	50
<b>Capacitor Switching - 60Hz</b>													
Single Capacitor - 40°C													
200 VAC [kVar]	5	5	8	9	12.5	14	20	20	28	28	28	28	28
230 VAC [kVar]	5	5	8	9	12.5	14	20	20	29	29	29	29	29
460 VAC [kVar]	5	5	8	10	15	20	25	25	40	50	50	50	50
600 VAC [kVar]	5	5	8	10	15	20	25	25	40	50	60	60	60
Capacitor Bank - 40°C													
200 VAC [kVar]	5	5	8	9	12.5	12.5	18	18	28	28	28	28	28
230 VAC [kVar]	5	5	8	9	12.5	12.5	18	18	29	29	29	29	29
460 VAC [kVar]	5	5	8	10	15	20	25	25	40	50	50	50	50
600 VAC [kVar]	5	5	8	10	15	20	25	25	40	50	50	50	50

① Inductance of leads between capacitors in parallel: min. 6 µH (CA7-9...CA7-30 = L min. 30 µH)

**Electrical Data**

		CA7-9	CA7-12	CA7-16	CA7-23	CA7-30	CA7-37	CA7-43	CA7-55	CA7-60	CA7-72	CA7-85	CA7-97
<b>Switching of Low Inductive Loads in Home Appliances and Similar Applications per IEC 61095 (50 Hz)</b>													
<b>AC-7a</b>													
230 VAC	[A]	32	32	32	32	45	45	63	63	~	~	~	~
400 VAC	[A]	32	32	32	32	45	45	63	63	~	~	~	~
440 VAC	[A]	32	32	32	32	45	45	63	63	~	~	~	~
<b>Switching of Motor Load Home Appliances - 50 Hz</b>													
<b>AC-7b</b>													
230 VAC	[A]	10.5	14	19	23	30	~	~	~	~	~	~	~
400 VAC	[A]	9	12	16	20	30	~	~	~	~	~	~	~
440 VAC	[A]	7.5	10	13.5	18	27	~	~	~	~	~	~	~
<b>Switching of Hermetically Sealed Cooling Compressor Motors - 50 Hz</b>													
<b>AC-8a</b> manual reset of overload release													
400 VAC	[A]	12	16	22	32	38	45	63	63	72	85	100	115
500 VAC	[A]	12	16	22	32	38	45	63	63	72	85	100	115
690 VAC	[A]	8	10	14	20	28	35	42	42	56	67	80	90
<b>AC-8b</b> automatic reset of overload release													
400 VAC	[A]	5.5	7	9.3	12	13	14	16	16	24	30	35	35
500 VAC	[A]	5.5	7	9.3	12	13	14	16	16	24	30	35	35
690 VAC	[A]	5.5	7	9.3	12	13	14	16	16	24	30	35	35

#### Electrical Data

DC-1 Switching - 60°C			CA7-9	CA7-12	CA7-16	CA7-23	CA7-30	CA7-37	CA7-43	CA7-55	CA7-60	CA7-72	CA7-85	CA7-97
1 Pole	24VDC	[A]	25	25	32	32	45	45	50	50	70	80	80	80
	48VDC	[A]	20	20	20	20	25	25	30	30	40	40	40	40
	60VDC	[A]	20	20	20	20	25	25	30	30	40	40	40	40
	110VDC	[A]	6	6	6	6	8	8	9	9	11	11	11	11
	220VDC	[A]	1.5	1.5	1.5	1.5	1.5	1.5	1.5	1.5	2	2	2	2
	440VDC	[A]	0.4	0.4	0.4	0.4	0.4	0.4	0.5	0.5	0.5	0.5	0.5	0.5
2 Poles in Series	24VDC	[A]	25	25	32	32	45	45	50	50	70	80	80	80
	48VDC	[A]	25	25	32	32	45	45	50	50	70	80	80	80
	60VDC	[A]	25	25	32	32	45	45	50	50	70	80	80	80
	110VDC	[A]	25	25	32	32	45	45	50	50	70	80	80	80
	220VDC	[A]	8	8	8	8	10	10	10	10	15	15	15	15
	440VDC	[A]	1	1	1	1	1	1	1	1	1.5	1.5	1.5	1.5
3 Poles in Series	24VDC	[A]	25	25	32	32	45	45	63	63	90	90	100	100
	48VDC	[A]	25	25	32	32	45	45	63	63	90	90	100	100
	60VDC	[A]	25	25	32	32	45	45	63	63	90	90	100	100
	110VDC	[A]	25	25	32	32	45	45	63	63	90	90	100	100
	220VDC	[A]	25	25	32	32	45	45	50	50	70	80	80	80
	440VDC	[A]	3	3	3	3	3.5	3.5	4	4	5	5	5	5
<b>DC-2, 3, 5 Switching - 60°C</b>														
Starting, reverse current braking, reversing, DC-5, 60°C	24VDC	[A]	25	25	32	32	45	45	63	63	90	90	100	100
	48VDC	[A]	25	25	32	32	45	45	50	50	70	70	80	80
	60VDC	[A]	25	25	32	32	45	45	50	50	70	70	80	80
Shunt Wound 3 Poles in Series	110VDC	[A]	20	20	25	25	30	30	35	35	70	70	80	80
	220VDC	[A]	6	6	6	10	15	15	20	20	25	25	30	30
	440VDC	[A]	0.6	0.6	0.6	0.6	0.6	0.6	0.6	0.6	0.6	0.6	0.6	0.6
Series-wound Motors 3 Poles in Series	24VDC	[A]	25	25	32	32	45	45	63	63	90	90	100	100
	48VDC	[A]	25	25	32	32	45	45	50	50	70	70	80	80
	60VDC	[A]	25	25	32	32	45	45	50	50	70	70	80	80
	110VDC	[A]	20	20	25	25	30	30	35	35	70	70	80	80
	220VDC	[A]	6	6	6	10	15	15	20	20	25	25	30	30
440VDC	[A]	0.6	0.6	0.6	0.6	0.6	0.6	0.6	0.6	0.6	0.6	0.6	0.6	

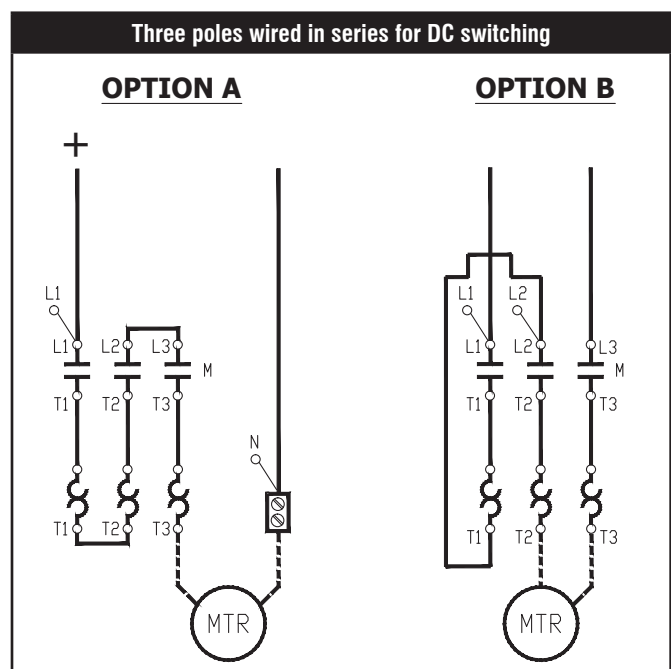



**Electrical Data**

	CA7-9	CA7-12	CA7-16	CA7-23	CA7-30	CA7-37	CA7-43	CA7-55	CA7-60	CA7-72	CA7-85	CA7-97
<b>Resistance and Watt Loss I<sub>e</sub> AC-3/ 400V</b>												
Resistance per power pole [mΩ]	2.7	2.7	2.7	2.0	2.0	2.0	1.5	1.0	0.9	0.9	0.9	0.6
Watt Loss - 3 power poles [W]	0.66	1.2	2.1	3.2	5.4	8.2	8.3	9.1	9.7	14.0	19.5	17
<b>Coil and 3 power poles</b>												
AC (coil warm) [W]	3.4	3.9	4.8	6.3	8.5	11.3	11.6	12.4	16.2	18	23.5	26
DC (coil warm) [W]	2.4	2.9	3.8	4.9	7.1	9.9	10.8	11.6	13.7	18	23.5	22
<b>Short-Circuit Coordination</b>												
<b>Max. Fuse or circuit breaker ratings</b>												
<b>DIN Fuses -gG, gL</b>												
Available Fault Current [KA]	50	50	50	50	50	50	50	50	50	50	50	50
Type "1" (690V) Ⓣ	[A]	50	50	50	80	125	125	160	160	250	250	250
Type "2" (690V) Ⓣ	[A]	25	35	35	40	80	80	100	100	160	160	200
<b>BS 88 Fuses</b>												
Available Fault Current [KA]	65	65	65	65	65	65	65	Ⓣ	65	65	65	Ⓣ
Type "1" (415V) Ⓣ	[A]	25	32	40	50	63	80	Ⓣ	100	160	160	Ⓣ
Type "2" (415V) Ⓣ	[A]	20	25	32	50	63	80	Ⓣ	100	125	160	Ⓣ
<b>cUL Short-Circuit Ratings</b>												
<b>Class K1, RK1, K5, and RK5 Fuses</b>												
Available Fault Current [KA]	5	5	5	5	5	5	5	5	5	10	10	10
cUL Max. Rating (600V) Ⓣ Type 1 [A]	35	40	70	90	110	125	150	200	200	250	300	350
<b>Class CC &amp; CSA HRCI Fuses</b>												
Available Fault Current [KA]	100	100	100	100	~	~	~	~	~	~	~	~
cUL Max. Rating (600V) Ⓣ Type 2 [A]	15	20	30	40	~	~	~	~	~	~	~	~
<b>Class J CSA &amp; HRCI-J Fuses</b>												
Available Fault Current [KA]	100	100	100	100	100	100	100	100	100	100	100	100
cUL Max. Rating (600V) Type 2 [A]	15	20	30	40	50	50	70	70	80	100	150	175
<b>Inverse-Time Circuit Breaker Ⓣ</b>												
Available Fault Current [KA]	5	5	5	5	5	5	5	5	5	10	10	10
cUL Max. Rating 480V Ⓣ Type 1 [A]	30	30	50	50	125	125	125	150	250	250	250	250
cUL Max. Rating 600V Ⓣ Type 1 [A]	~	~	~	~	125	125	125	150	250	250	250	250
<b>Short Time Current Withstand Ratings</b>												
I <sub>cw</sub> 60° C 10 s [A]	170	170	170	215	300	304	375	375	700	700	700	840
Off Time Between Operations [Min.]	20	20	20	20	20	20	20	20	20	20	20	20

Ⓣ When used as a Branch Circuit Protection device, NEC 430-152 defines the maximum rating of an Inverse-time circuit breaker to be sized at 250% of the motor nameplate FLA for most applications.

Ⓣ UL Listed Combination. (UL File E41850) Per UL508A, NEC409 abd CSA 22.2 No.14 for contactor and fuses or circuit breaker only.

Ⓣ Per IEC 60947-1 for contactor and fuses only.

Ⓣ To be determined - Test data not available at time of this printing.

Short Circuit Ratings

High Fault Short Circuit Ratings per UL508 and CSA 22.2 No.14

CEP7 Third Generation Cat. No.	Contactor Cat. No.	Max. starter FLC (A)	Fuse Ratings			UL Listed Circuit Breaker Ratings			
			Max. avail- able fault current (kA)	Max. voltage (V)	UL Class J/CC/ CSA HRCI-J fuse max. (A)	Short Circuit Rating (kA)	Max. voltage (V)	Max. CB Rating (A)	
CEP7	1EEAB, 1EFAB	CA7-9	0.5	100	600	3	5 ~	480 600	30 ~
	1EEBB, 1EFBB		1			6			
	1EECB, 1EFDB, 1EEDB, 1EFDB, 1EEEB, 1EFEB	CA7-9	09			20			
		CA7-12 CAN7-12	12			20			
		CA7-16 CAN7-16	16	30	5 ~	480 600	50 ~		
		CA7-23	23	30					
	1EEED, 1EFED, 1EEFD, 1EFFD	CA7-30	30	50	65 25	480 600	50		
		CA7-37 CAN7-37	37	50					
		CA7-43 CAN7-43	43	70	65 25	480 600	80		
		CA7-55	55	70					
	1EEGE, 1EFGE	CA7-60	60	80	65 25	480 600	125 125		
		CA7-72	72	100					
		CA7-85 CAN7-85	85	150	65 25	480 600	125 125		
		CA7-97	97	175					

## Short Circuit Ratings

### Standard Fault Short Circuit Ratings per UL508 and CSA 22.2 No.14

CEP7 Third Generation Cat. No.		Max. available fault current (kA)	Conditional S.C. current, I <sub>q</sub> (kA)	S.C.P.D.
CEP7	1EEAB, 1EFAB, 1EEBB, 1EFBB	1	600V Max. Voltage	Suitable for use with fuses only
	1EECB, 1EFCB, 1EEDB, 1EFDB, 1EEEB, 1EFEB 1EEED, 1EFED, 1EEFD, 1EFFD	5		Not restricted to fusing only
	1EEGE, 1EFGE	10		







### IEC Short Circuit Ratings per EN60947-4-1

CEP7 Third Generation Cat. No.		Prospective S.C. current, I <sub>r</sub> (kA)	Conditional S.C. current, I <sub>q</sub> (kA)	Max. voltage (V)	S.C.P.D.
CEP7	1EEAB, 1EFAB, 1EEBB, 1EFBB	1	100	690	Suitable for use with fuses only
	1EECB, 1EFCB, 1EEDB, 1EFDB, 1EEEB, 1EFEB	1			Not restricted to fusing only
	1EEED, 1EFED, 1EEFD, 1EFFD	3			
	1EEGE, 1EFGE	5			

### IEC Type I and Type II Fuse Coordination with CA7 Series contactors per EN60947-4-1

CEP7 Third Generation Cat. No.	Contactors Cat. No.	Max. starter FLC (A)	Prospective S.C. current/ I <sub>r</sub> (kA)	Conditional S.C. current/ I <sub>q</sub> (kA)	Max. voltage (V)	Type I with Class J fuse max. (A)	Type II with Class J fuse max. (A)	
CEP7	1EEAB, 1EFAB 1EEBB, 1EFBB	0.5	1	100	600	3	3	
		1				6	6	
	1EECB, 1EFCB, 1EEDB, 1EFDB	CA7-9	9			1	20	15
		CA7-12	12				20	20
		CA7-16	16				30	30
		CA7-23	23				30	30
	1EEEB, 1EFEB	CA7-9	9			3	20	15
		CA7-12	12				20	20
		CA7-16	16				30	30
		CA7-23	23				30	30
	1EEED, 1EFED, 1EEFD, 1EFFD	CA7-30	30			3	50	50
		CA7-37	37				50	50
		CA7-43	43				70	70
		CA7-55	55				70	70
	1EEGE, 1EFGE	CA7-60	60			3	80	80
		CA7-72	72				100	100
		CA7-85	85				150	150
		CA7-60	60			5	80	80
		CA7-72	72				100	100
		CA7-85	85				150	150
CA7-97	97		175	175				

#### Electro-Mechanical Data









			CA7-9	CA7-12	CA7-16	CA7-23	CA7-30	CA7-37	CA7-43	CA7-55	CA7-60	CA7-72	CA7-85	CA7-97
<b>Service Life</b>														
Mechanical	AC	[Mil.]	13	13	13	13	13	13	12	12	6	6	6	6
	DC	[Mil.]	13	13	13	13	13	13	13	13	6	6	6	6
Electrical AC-3 (400V)	AC	[Mil.]	1.3	1.3	1.3	1.3	1.3	1.3	1.0	0.8	1.0	1.0	1.0	1.0
<b>Shipping Weights</b>														
AC - CA7		[kg]	0.39	0.39	0.39	0.39	0.48	0.49	0.51	0.51	1.45	1.45	1.45	1.45
		[Lbs.]	0.86	0.86	0.86	0.86	1.06	1.08	1.12	1.12	3.20	3.20	3.20	3.20
AC -CAU7		[kg]	0.85	0.85	0.85	0.85	1.08	1.08	1.15	1.15	3.14	3.14	3.14	3.14
		[Lbs.]	1.89	1.89	1.89	1.89	2.39	2.39	2.54	2.54	6.92	6.92	6.92	6.92
DC - CA7		[kg]	0.41	0.41	0.41	0.41	0.45	0.45	0.60	0.60	1.47	1.47	1.47	1.47
		[Lbs.]	0.90	0.90	0.90	0.91	1.00	1.00	1.32	1.32	3.24	3.24	3.24	3.24
DC - CAU7		[kg]	0.89	0.89	0.89	0.90	0.98	0.98	1.33	1.33	3.22	3.22	3.22	3.22
		[Lbs.]	1.97	1.97	1.97	1.99	2.17	2.17	3.93	2.93	7.10	7.10	7.10	7.10
<b>Terminations - Power</b>														
Description			 One saddleclamp per pole: cross, slotted or Pozidrive No. 2/blade No. 3 screw				 Dual connection; one saddleclamp and one box lug per pole; cross, slotted or Pozidrive No. 2/blade No. 4 screw				 Dual connection; two box lugs per pole Allen Head: 4mm, 5/32			
	1 Wire	[mm <sup>2</sup> ]	1...4				2.5...16				2.5...35			
	2 Wires	[mm <sup>2</sup> ]	1...4				2.5...10				2.5...25			
	1 Wire	[mm <sup>2</sup> ]	1.5...6				2.5...25				2.5...50			
	2 Wires	[mm <sup>2</sup> ]	1.5...6				2.5...16				2.5...35			
	1 Wire	[AWG]	16...10				14...4				14...1			
	2 Wires	[AWG]	16...10				14...4				14...1			
Torque Requirement		[Nm]	1.5...2.0				2.5...3.5				4.5...6			
		[Lb-in]	13.3...17.7				22...31				40...53			
<b>Terminations - Control</b>														
Description			 Combination Screw Head: Cross, Slotted, Pozidrive											
Coils	1 or 2	[mm <sup>2</sup> ]					1...2.5							
Wires		[AWG]					16...12							
Control Modules	1 or 2	[mm <sup>2</sup> ]					1...4							
Wires		[AWG]					16...12							
Torque Requirement		[Nm]					1...1.5							
		[Lb-in]					8.9...13							
<b>Degree of Protection - contactor</b>			CA7-9...23: IP2X from all directions CA7-30...55: IP2X from front with front (upper) terminal wired CA7-60...97: IP2X from front with front (upper) terminal wired (min. wire size 16mm <sup>2</sup> or #6 AWG)											
<b>Protection Against Accidental Contact</b>			Safe from touch by fingers and back-of-hand per VDE 0106; Part 100											

#### Environmental and General Specifications

<b>Ambient Temperature</b> ①	
Storage	-55...+80° C (-67...176° F) - [CRI7E Electronic Interface -50...+80° C (-58...176° F)]
Operation	-25...+60° C (-13...140° F) (40° C per UL)
Conditioned 15% current reduction after AC-1 at >60° C	-25...+70° C (-13...158° F)
<b>Altitude at installed site</b>	2000 meters above sea level per IEC 60947-1
<b>Resistance to Corrosion/Humidity</b>	Damp-alternating climate: cyclic to IEC 68-2, 56 cycles Dry heat: IEC 68-2, +100° C (212° F), relative humidity <50%, 7 days. Damp tropical: IEC 68-2, +40° C (104° F), relative humidity <92%, 56 days.
<b>Shock Resistance</b>	IEC 60068-2-27: Half sinusoidal shock 11ms, 30g (in all three directions)
<b>Vibration Resistance</b>	IEC 60068-2-6: Static > 2g, in normal position no malfunction <5g
<b>Pollution Degree</b>	3
<b>Operating Position</b>	Refer to Dimension Pages
<b>Standards</b>	IEC/EN 60947-1/-4-1/-5-1; UL508; CSA 22.2 No. 14
<b>Approvals</b>	CE, cULus, CCC

① Ambient is the temperature outside the enclosure.

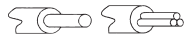
**Lug Kit and Paralleling Link Specifications**

			CA7-P-KN23 / KL23		CA7-P-K37	CA7-P-K43	CA7-P-K85	CA7-P-B23	CA7-P-B37
<b>Approvals</b>			UL Listed; CSA Certified; C						
<b>Conformity to Standards</b>			UL508; CSA 22.2 No. 14; IEC 60947-4						
<b>Protection Against Accidental Contact</b>			IP2LX Finger Protection						
<b>Terminations</b>									
<b>Description</b>			Cross, slotted or Pozidrive screw		Allen Head; 5mm, 3/16	Allen Head; 7 mm, 15/32			
<b>Wire Size</b>									
	1 Wire	[mm <sup>2</sup> ]	4...16	4..16	6...35	10...70	35...70	35...70	
	1 Wire	[mm <sup>2</sup> ]	4...25	4..25	6...50	10...95	35...95	35...95	
	1 Wire	[AWG]	10...4	10...4	8...2	8..2/0	0...2/0	0...2/0	
<b>Torque Requirement</b>			[Nm]	2...3	2...3	3..6	8...12	6...12	6...12
			[Lb-in]	18...27	18...27	27...54	72...108	54...108	54...108

**Coil Data - AC / Two Winding DC**

			CA7-9...12	CA7-16	CA7-23	CA7-30...37	CA7-43...55	CA7-60...85	CA7-97	
<b>Voltage Range</b>										
AC: 50Hz, 60Hz, 50/60 Hz	Pickup	[xU <sub>s</sub> ]							0.85...1.1	
	Dropout	[xU <sub>s</sub> ]							0.3...0.6	
DC: Two Winding (60D...97D)	Pickup	[xU <sub>s</sub> ]	0.8...1.1 (9V coils = 0.65...1.3; 24V coils = 0.7...1.25)							
	Dropout	[xU <sub>s</sub> ]	0.1...0.6							
<b>Coil Consumption</b>										
AC: 50Hz, 60Hz, 50/60 Hz	Pickup	[VA]	75	75	105	105	135	235	400VA/240W	
	Hold-in	[VA/W]	9.5/2.7	9.5/2.7	12.3/3.1	12.3/3.1	13.3/3.3	19/6.5	24/9	
DC: Two Winding (60D...97D)	Pickup	[W]	~						200	325
	Hold-in	[W]	~						4.5	5.5
<b>Operating Times</b>										
AC: 50Hz, 60Hz, 50/60 Hz	Pickup	[ms]	15...30	15...30	15...30	15...30	15...30	20...40	20...40	
	Dropout	[ms]	10...60	10...60	10...60	10...60	10...60	10...60	20...40	
with RC Suppressor	Dropout	[ms]	10...60	10...60	10...60	10...60	10...60	10...60	20...40	
DC: Two Winding (60D...97D)	Pickup	[ms]	~						20...40	15...25
	Dropout	[ms]	~						20...35 ①	15...25 ①

**Coil Data - Electronic DC**

<b>Voltage Range</b>			<b>Coil Consumption &amp; Operating Times ②</b>						
Voltage Code	Nominal Voltage US [VDC]	Ratings [xU <sub>s</sub> ]	Average/Peak Pickup [W]		Hold-in [W]		Dropout Voltage [xU <sub>s</sub> ]	Pickup [ms]	Dropout [ms]
			CA7-9E...37E	CA7-43E...55E	CA7-9E...37E	CA7-43E...55E			
12E	12	0.7...1.25	10/17	16/25	1.7	2.5	0.3...0.4	25...50	27...45
24E	24	0.7...1.25	10/17	16/25	1.7	2.5			
36E	36...48	0.7...1.25	10/17	16/25	1.7...1.9	2.5...2.7			
48E	48...72	0.8...1.25	10/17	16/25	1.7...1.9	2.5...2.7			
110E	110...125	0.7...1.12 ③	12/19	16/26	2.0...2.1	2.7...2.8	0.3...0.4	25...50	23...33
220E	220...250	0.8...1.1	14/22	18/29	2.7...3.0	3.5...4.0			

① ≤ 220V.

② The hold-in demand of the CA7-9E...55E is very low but the pick-up demand is approximately 1 ampere at 24 VDC. When sizing (dimensioning) a power supply for applications involving parallel switched contactors then multiply the peak demand by the number of contactors to be simultaneously switched and add to the hold-in demand of all other control circuit burdens, including other contactors, pilot devices, solenoids, etc.

③ At 110VDC, coil code 110E has an operating range of 0.7...1.25 xU<sub>s</sub>.

**Electrical Data**

	CA7-9-M40 (31; 22)	CA7-12-M40 (31; 22)	CA7-16-M40 (31; 22)	CA7-23-M40 (31; 22)	CA7-40-M22	CA7-40-M40	CA7-90-M22	CA7-90-M40
<b>Rated Insulation Voltage <math>U_i</math></b>								
IEC, AS, BS, SEV, VDE 0660	690V							
UL; CSA	600V							
<b>Rated Impulse Voltage <math>U_{imp}</math></b>	8 kV							
<b>Rated Voltage <math>U_e</math> - Main Contacts</b>								
AC 50/60Hz	115, 200, 208, 230, 240, 380, 400, 415, 460, 500, 575, 690V							
DC	24, 48, 110, 115, 220, 230, 300, 440V							
<b>Operating Frequency for AC Loads</b>	50...60Hz							

**Switching Motor Loads**

**Standard IEC Ratings**

AC-2, AC-3, AC-4	230V	[A]	12	15	20	26.5	38	38	85	85
DOL & Reversing	240V	[A]	12	15	20	26.5	38	38	85	85
50Hz/60°C	400V	[A]	9	12	16	23.	37	37	85	85
	415V	[A]	9	12	16	23	37	37	85	85
	500V	[A]	7	10	14	20	29	30	80	80
	690V	[A]	5	7	9	12	9	21	22	49
	230V	[kW]	3	4	5.5	7.5	11	11	25	25
	240V	[kW]	3	4	5.5	7.5	11	11	25	25
	400V	[kW]	4	5.5	7.5	11	18.5	18.5	45	45
	415V	[kW]	4	5.5	7.5	11	18.5	18.5	45	45
	500V	[kW]	4	5.5	7.5	13	18.5	20	55	55
	690V	[kW]	4	5.5	7.5	10	7.5	18.5	18.5	45

**UL/CSA**

DOL & Reversing	115V	[A]	7.2	9.8	16	24	34	34	80	80		
60Hz/60°C	1Ø	230V	[A]	18	12	17	17	28	28	68	68	
		115V	[HP]	1/2	1/2	1	2	3	3	7-1/2	7-1/2	
		230V	[HP]	1-1/2	2	3	3	5	5	15	15	
		200V	[A]	7.8	11	17.5	17.5	32.2	32.2	78.2	78.2	
		230V	[A]	6.8	9.6	15.2	22	28	28	80	80	
		460V	[A]	7.6	11	14	21	34	34	65	77	
		575V	[A]	9	11	17	17	17	32	22	52	
		200V	[HP]	2	3	5	5	10	10	25	25	
		230V	[HP]	2	3	5	7-1/2	10	10	30	30	
		460V	[HP]	5	7-1/2	10	15	25	25	50	60	
		575V	[HP]	7-1/2	10	15	15	15	30	20	50	
		Maximum Operating Rate (at max. amps)	AC2	[ops/hr]	450	450	450	400	400	400	200	200
			AC3	[ops/hr]	700	700	700	600	600	600	500	500
			AC4	[ops/hr]	200	150	120	80	70	70	50	50

**Electrical Data**

			CA7-9-M40 (31; 22)	CA7-12-M40 (31; 22)	CA7-16-M40 (31; 22)	CA7-23-M40 (31; 22)	CA7-40-M22	CA7-40-M40	CA7-90-M22	CA7-90-M40	
<b>AC-1 Load, 3Ø Switching</b>											
Ambient Temperature 40°C			$I_{th}$ [A]	32	32	32	32	75	75	130	130
	230V	[kW]	13	13	13	13	30	30	52	52	
	240V	[kW]	13	13	13	13	31	31	54	54	
	400V	[kW]	22	22	22	22	52	52	90	90	
	415V	[kW]	23	23	23	23	54	54	93	93	
	500V	[kW]	28	28	28	28	65	65	113	113	
	690V	[kW]	38	38	38	38	90	90	155	155	
Ambient Temperature 60°			$I_{th}$ [A]	32	32	32	32	60	60	110	110
	230V	[kW]	13	13	13	13	24	24	44	44	
	240V	[kW]	13	13	13	13	25	25	46	46	
	400V	[kW]	22	22	22	22	42	42	76	76	
	415V	[kW]	23	23	23	23	43	43	79	79	
	500V	[kW]	28	28	28	28	52	52	95	95	
	690V	[kW]	38	38	38	38	72	72	131	131	
Max Operating Rate			[ops/hour]	1,000	1,000	1,000	1,000	300	300	600	600
<b>Continuous Current (UL/CSA)</b>											
General Purpose Rating (40°)			Open [A]	25	25	30	30	60	60	125	130
			Enclosed [A]	25	25	30	30	60	60	125	130
Max. Operating Rate			[ops/hour]	1,400	1,400	1,200	1,200	1,000	1,000	600	600
<b>Lighting Loads ①</b>											
Elec. Dischrg.Lamps- AC-5a, single compensated			Open [A]	22.5	25	28	29	65	65	115	115
			Enclosed [A]	22.5	25	28	29	54	54	95	95
Incandescent Lamps AC-5b, Electrical endurance~100,000 operations				12	16	18	22	18	25	60	75
<b>DC-1 Switching - 60°C</b>											
1 Pole			24VDC [A]	25	25	32	32	45	45	80	80
			48VDC [A]	20	20	20	20	25	25	40	40
			60VDC [A]	20	20	20	20	25	30	40	40
			110VDC [A]	6	6	6	6	10	10	11	11
			220VDC [A]	1.5	1.5	1.5	1.5	1.5	1.5	1.8	1.8
			440VDC [A]	0.4	0.4	0.4	0.4	0.4	0.4	0.5	0.5
2 Pole in Series			24VDC [A]	25	25	32	32	45	45	80	80
			48VDC [A]	25	25	32	32	45	45	80	80
			60VDC [A]	25	25	32	32	45	45	80	80
			110VDC [A]	25	25	32	32	45	45	80	80
			220VDC [A]	8	8	8	8	10	10	15	15
			440VDC [A]	1	1	1	1	1	1	1.5	1.5
3 Poles in Series ②			24VDC [A]	25	25	32	32	~	48	~	100
			48VDC [A]	25	25	32	32	~	48	~	100
			60VDC [A]	25	25	32	32	~	48	~	100
			110VDC [A]	25	25	32	32	~	48	~	100
			220VDC [A]	25	25	32	32	~	48	~	80
			440VDC [A]	3	3	3	3	~	3.5	~	5
4 Poles in Series			24VDC [A]	25	25	32	32	~	60	~	110
			48VDC [A]	25	25	32	32	~	60	~	110
			60VDC [A]	25	25	32	32	~	60	~	110
			110VDC [A]	25	25	32	32	~	60	~	110
			220VDC [A]	25	25	32	32	~	60	~	100
			440VDC [A]	8	8	8	8	~	10	~	15

① CA7 ratings for lighting loads are provided for technical reference. For cUL rated and labeled devices, see CAL7 contactors listed in this section.

② See page A64 for Three poles wired in series for DC switching

#### Electrical Data

		CA7-9-M40 (31; 22)	CA7-12-M40 (31; 22)	CA7-16-M40 (31; 22)	CA7-23-M40 (31;22)	CA7-40-M22	CA7-40-M40	CA7-90-M22	CA7-90-M40	
<b>Resistance and Watt Loss I<sub>e</sub> AC-3/ 400V</b>										
Resistance per power pole	[mΩ]	2.7	2.7	2.7	2.0	2.0	1.5	0.8	0.7	
Watt Loss - 4 power poles	[W]	0.66	1.2	2.1	3.2	11.3	8.4	13.5	11.8	
Coil and 4 power poles	AC	[W]	3.4	3.9	4.8	6.3	8.8	9.5	36	56.3
	DC	[W]	2.4	2.9	3.8	4.9	8	8.7	32.5	52.8
<b>Short Circuit Coordination</b>										
<b>DIN Fuses -gG, gL</b>										
Available Fault Current	[A]	100 KA	100 KA	100 KA	100 KA	50 KA	50 KA	50 KA	50 KA	
Type "1" (690V) Ⓢ	[A]	50	50	50	80	160	160	250	250	
Type "2" (690V) Ⓢ	[A]	25	35	35	40	100	100	160	160	
<b>BS 88 Fuses</b>										
Available Fault Current	[A]	80 KA	80 KA	80 KA	80 KA	~	~	~	~	
Type "1" (690V) Ⓢ	[A]	25	32	35	50	~	~	~	~	
Type "2" (690V) Ⓢ	[A]	25	32	35	50	~	~	~	~	
<b>Class K1, RK1 Fuses</b>										
Available Fault Current	[A]	100 KA	100 KA	100 KA	100 KA	100 KA	100 KA	100 KA	100 KA	
Type "2" (600V) Ⓢ	[A]	15	20	20	30	70	70	100	100	
<b>cUL Short-Circuit Ratings</b>										
<b>Class K1, RK1, K5, and RK5 Fuses</b>										
Available Fault Current	[A]	5 KA	5 KA	5 KA	5 KA	5 KA	5 KA	10 KA	10 KA	
cUL Max. Rating (600V) Ⓢ Type 1	[A]	35	40	70	90	125	125	300	300	
<b>Class CC &amp; CSA HRCI Fuses</b>										
Available Fault Current	[A]	100 KA	100 KA	100 KA	100 KA	~	~	~	~	
cUL Max. Rating (600V) Ⓢ Type 2	[A]	15	20	30	30	~	~	~	~	
<b>Class J CSA &amp; HRCI-J Fuses</b>										
Available Fault Current	[A]	100 KA	100 KA	100 KA	100 KA	100 KA	100 KA	100 KA	100 KA	
cUL Max. Rating (600V) Ⓢ Type 2	[A]	15	20	30	30	70 Ⓢ	70 Ⓢ	150 Ⓢ	150 Ⓢ	
<b>Inverse-Time Circuit Breaker Ⓢ</b>										
Available Fault Current	[A]	5 KA	5 KA	5 KA	5 KA	5 KA	5 KA	10 KA	10 KA	
cUL Max. Rating 480V Ⓢ Type 1	[A]	30	30	50	50	125	125	250	250	
cUL Max. Rating 600V Ⓢ Type 1	[A]	~	~	~	~	125	125	250	250	
<b>Short Time Current Withstand Ratings</b>										
I <sub>cw</sub> 60° C	[A]	170	170	170	215	304	304	700	700	
Off Time Between Operations	[Min.]	20	20	20	20	5	5	5	5	

Ⓢ When used as a Branch Circuit Protection device, NEC 430-152 defines the maximum rating of an Inverse-time circuit breaker to be sized at 250% of the motor nameplate FLA for most applications.

Ⓢ UL Listed Combination. (UL File E41850) Per UL508A, NEC409 abd CSA 22.2 No.14 for contactor and fuses or circuit breaker only.

Ⓢ Per IEC 60947-1 for contactor and fuses only.

Ⓢ UL Testing not complete a the time of printing this catalog.



**Mechanical Data**

			CA7-9-M40 (31; 22)	CA7-12-M40 (31; 22)	CA7-16-M40 (31; 22)	CA7-23-M40 (31; 22) CAL7-20	CA7-40-M22	CA7-40-M40 CAL7-30	CA7-90-M22	CA7-90-M40 CAL7-60	
<b>Service Life</b>											
Mechanical	AC	[Mil.]	13	13	13	13	10	10	10	10	
	DC	[Mil.]	13	13	13	13	10	10	10	10	
<b>Shipping Weights</b>											
AC - CA7		[kg]	0.39	0.39	0.39	0.39	0.51	0.51	1.45	1.45	
		[Lbs.]	0.86	0.86	0.86	0.86	1.12	1.12	3.20	3.20	
DC - CA7		[kg]	0.41	0.41	0.41	0.41	0.59	0.59	1.47	1.47	
		[Lbs.]	0.90	0.90	0.90	0.91	1.30	1.30	3.24	3.24	
<b>Terminations - Power</b>											
Description											
			One saddleclamp per pole: cross, slotted or Pozidrive No. 2/blade No. 3 screw				Dual connection; one saddleclamp and one box lug per pole; cross, slotted or Pozidrive No. 2/ blade No. 4 screw		Dual connection; two box lugs per pole Allen Head: 4mm, 5/32		
	1 Wire	[mm <sup>2</sup> ]	1...4	1...4	1...4	1...4	2.5...10	2.5...10	2.5...16	2.5...35	
	2 Wires	[mm <sup>2</sup> ]	1...4	1...4	1...4	1...4	2.5...10	2.5...10	2.5...10	2.5...25	
	1 Wire	[mm <sup>2</sup> ]	1.5...6	1.5...6	1.5...6	1.5...6	2.5...16	2.5...16	2.5...25	2.5...50	
	2 Wires	[mm <sup>2</sup> ]	1.5...6	1.5...6	1.5...6	1.5...6	2.5...16	2.5...16	2.5...16	2.5...35	
	1 Wire	[AWG]	16...10	16...10	16...10	16...10	14...6	14...6	14...4	14...1	
	2 Wires	[AWG]	16...10	16...10	16...10	16...10	14...6	14...6	14...4	14...1	
Torque Requirement		[Nm]	1.5...2.0	1.5...2.0	1.5...2.0	1.5...2.0	2.5...3.5	2.5...3.5	3.5...6	3.5...6	
		[Lb-in]	13.3...17.7	13.3...17.7	13.3...17.7	13.3...17.7	22...31	22...31	31...52	31...52	
<b>Terminations - Control</b>											
Description											
			Combination Screw Head: Cross, Slotted, Pozidrive								
Coils	1 or 2	[mm <sup>2</sup> ]	1...2.5								
Wires		[AWG]	16...12								
Control Modules	1 or 2	[mm <sup>2</sup> ]	1...4								
Wires		[AWG]	16...12								
Torque Requirement		[Nm]	1...1.5								
		[Lb-in]	8.9...13								
<b>Degree of Protection - contactor</b>			CA7-9...23: IP2X from all directions CA7-30...55: IP2X from front with front (upper) terminal wired CA7-60...97: IP2X from front with front (upper) terminal wired (min. wire size 16mm <sup>2</sup> or #6 AWG)								
<b>Protection Against Accidental Contact</b>			Safe from touch by fingers and back-of-hand per VDE 0106; Part 100								

**Environmental and General Specifications**

<b>Ambient Temperature</b> ①	
Storage	-55...+80° C (-67...176° F) - [CRI7E Electronic Interface -50...+80° C (-58...176° F)]
Operation	-25...+60° C (-13...140° F) (40° C per UL)
Conditioned 15% current reduction after AC-1 at >60° C	-25...+70° C (-13...158° F)
<b>Altitude at installed site</b>	2000 meters above sea level per IEC 60947-1
<b>Resistance to Corrosion/Humidity</b>	Damp-alternating climate: cyclic to IEC 68-2, 56 cycles Dry heat: IEC 68-2, +100° C (212° F), relative humidity <50%, 7 days. Damp tropical: IEC 68-2, +40° C (104° F), relative humidity <92%, 56 days. IEC 60068-2-27: Half sinusoidal shock 11ms, 30g (in all three directions) IEC 60068-2-6: Static > 2g, in normal position no malfunction <5g
<b>Shock Resistance</b>	
<b>Vibration Resistance</b>	
<b>Pollution Degree</b>	3
<b>Operating Position</b>	Refer to Dimension Pages
<b>Standards</b>	IEC/EN 60947-1/-4-1/-5-1; UL508; CSA 22.2 No. 14
<b>Approvals</b>	CE, cULus, CCC

① Ambient is the temperature outside the enclosure.

#### Coil Data - AC / Two Winding DC

			CA7-9-M40 (31; 22)	CA7-12-M40 (31; 22)	CA7-16-M40 (31; 22)	CA7-23-M40 (31; 22)	CA7-40-M22 CAL7-20	CA7-40-M40 CAL7-30	CA7-90-M22	CA7-90-M40 CAL7-60
<b>Voltage Range</b>										
AC: 50Hz, 60Hz, 50/60 Hz	Pickup	[xU <sub>s</sub> ]							0.85...1.1	
	Dropout	[xU <sub>s</sub> ]							0.3...0.6	
DC, Two Winding (90D)	Pickup	[xU <sub>s</sub> ]	0.8...1.1 (9V coils = 0.65...1.3; 24V coils = 0.7...1.25)							
	Dropout	[xU <sub>s</sub> ]	0.1...0.6							
<b>Coil Consumption</b>										
AC: 50Hz, 60Hz, 50/60 Hz	Pickup	[VA]	75	75	75	105	135	135	400VA/240W	400VA/240W
	Hold-in	[VA/W]	9.5/2.7	9.5/2.7	9.5/2.7	12.3/3.1	13.3/3.3	13.3/3.3	24/9	24/9
DC: Two Winding (90D)	Pickup	[W]	~	~	~	~	~	~	325	325
	Hold-in	[W]	~	~	~	~	~	~	5.5	5.5
<b>Operating Times</b>										
AC: 50Hz, 60Hz, 50/60 Hz	Pickup	[ms]	15...30	15...30	15...30	15...30	15...30	15...30	20...30	20...40
	Dropout	[ms]	10...60	10...60	10...60	10...60	10...60	10...60	20...40	20...40
with RC Suppressor	Dropout	[ms]	10...60	10...60	10...60	10...60	10...60	10...60	20...40	20...40
DC: Two Winding (90D)	Pickup	[ms]	~	~	~	~	~	~	15...20	15...25
	Dropout	[ms]	~	~	~	~	~	~	20...25	15...25

#### Coil Data - Electronic DC

Voltage Range			Coil Consumption & Operating Times ①						
Voltage Code	Nominal Voltage US [VDC]	Ratings [xU <sub>s</sub> ]	Average/Peak Pickup [W]		Hold-in [W]		Dropout Voltage [xU <sub>s</sub> ]	Pickup [ms]	Dropout [ms]
			CA7-9E...37E	CA7-40E	CA7-9E...37E	CA7-40E			
12E	12	0.7...1.25	10/17	16/25	1.7	2.5	0.3...0.4	25...50	27...45
24E	24	0.7...1.25	10/17	16/25	1.7	2.5			
36E	36...48	0.7...1.25	10/17	16/25	1.7...1.9	2.5...2.7			
48E	48...72	0.8...1.25	10/17	16/25	1.7...1.9	2.5...2.7			
110E	110...125	0.7...1.12 ②	12/19	16/26	2.0...2.1	2.7...2.8	0.3...0.4	25...50	23...33
220E	220...250	0.7...1.1	14/22	18/29	2.7...3.0	3.5...4.0			

① The hold-in demand of the CA7-9E...55E is very low but the pick-up demand is approximately 1 ampere at 24 VDC. When sizing (dimensioning) a power supply for applications involving parallel switched contactors then multiply the peak demand by the number of contactors to be simultaneously switched and add to the hold-in demand of all other control circuit burdens, including other contactors, pilot devices, solenoids, etc.

② At 110VDC, coil code 110E has an operating range of 0.7...1.25 xU<sub>s</sub>.

**Technical Information – Auxiliary Contact Data**

			Built-in Auxiliary Contacts in Contactor CA7-9...CA7-23	Front Mounted Auxiliary Contacts CA7-PV, CS7-PV, CZE/A7, CV7	Front Mounted Bifurcated Auxiliary Contacts	Side Mounted Auxiliary Contacts CA-PA, CM7
Electrical Contact Ratings - NEMA			A600, P600	A600, Q600		A600, Q600
Min. Contact Rating			17V, 10 mA	17V, 5 mA	5V, 3 mA	17V, 10 mA
Contact Ratings - IEC AC-15 (solenoids, contactors) rated voltage IEC 60947-5-1		24V	10 A	6 A	3 A	6 A
		48V	10 A	6 A	3 A	6 A
		120V	10 A	6 A	3 A	6 A
		240V	10 A	5 A	3 A	5 A
		400V	6 A	3 A	2 A	3 A
		480V/500V	2.5 A	1.6 A	1.2 A	1.6 A
		600V	1 A	1 A	0.7 A	1 A
AC-12 (Control of resistive loads) IEC 60947-5-1	40 °C	$I_{th}$	20 A	10 A	10 A	10 A
		230V	8 kW			
		400V	14 kW			
		690V	24 kW			
	60 °C	$I_{th}$	20 A	6 A	6 A	6 A
		230V	8 kW			
		400V	14 kW			
DC-12 Switching DC Loads $t_{cr} < 1$ ms, Resistive Loads IEC 60947-5-1		24V	12 A	12 A	6 A	6 A
		48V	9 A	9 A	3.2 A	3.2 A
		110V	3.5 A	3.5 A	0.45 A	0.45 A
		220V	0.55 A	0.55 A	0.18 A	0.18 A
		440V	0.2 A	0.2 A	0.1 A	0.1 A
DC-13 IEC 60947-5-1, Solenoids and contactors		24V	5 A	5 A	2.5 A	5 A
		48V	3 A	3 A	1.5 A	3 A
		110V	1.2 A	1.2 A	0.6 A	1.2 A
		220V	0.6 A	0.6 A	0.3 A	0.6 A
		440V	0.3 A	0.15 A	0.15 A	0.15 A

**Terminal Marking Information for Built In Auxiliary Contacts**

CA7-9...23-10 Typical

CA7-9...23-01 Typical



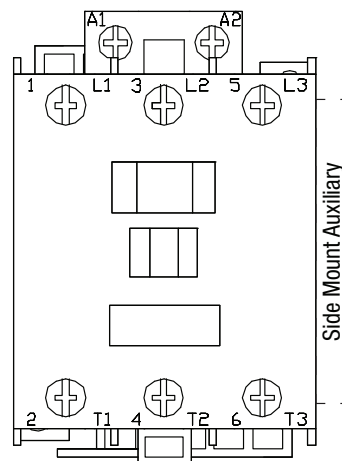
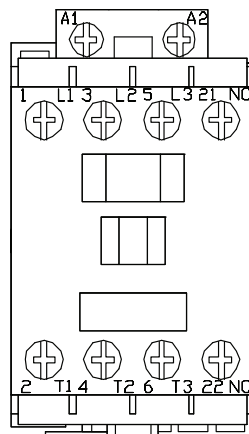
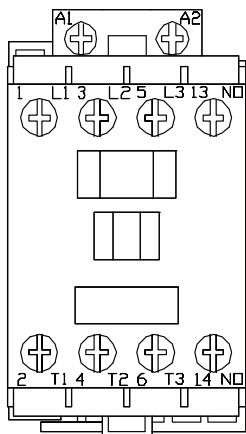



CA7-30...97 Typical



## Auxiliary Contacts

			Built-in Auxiliary Contacts in Contactor CA7-9...CA7-23	Front Mounted Auxiliary Contacts CA7-PV, CS7-PV, CZE/A7, CV7	Side Mounted Auxiliary Contacts CA-PA, CM7
<b>Continuous Current Rating per UL/CSA</b>					
Rated Voltage	AC	[V]	600 max.	600 max.	600 max.
Continuous Rating	40°C	[A]	10 A general purpose Heavy pilot duty (A600)	10 A general purpose Heavy pilot duty (A600)	10 A general purpose Heavy pilot duty (A600)
Continuous Rating	DC	[A]	5A, 600 max. Standard pilot duty (P600)	2.5A, 600 max. Standard pilot duty (Q600)	2.5A, 600 max. Standard pilot duty (Q600)
<b>Short-Circuit Protection -gGFuse</b>					
Type 2 Coordination		[A]	20	10	10
<b>Rated Impulse Voltage <math>U_{imp}</math></b>					
		[kV]	8	8	6
Insulation Voltage (between control and load circuit) per DIN < VDE 0103, Part 101 (NAMUR recommendation)					
		[V]	380	440	440
<b>Mechanically Linked Contacts</b> (per IEC60947-5-1 ● Annex L (SUVA Third-party certified))					
			Mutually unrestricted between all NO and NC contacts	Mutually unrestricted between all NO & NC contacts. CZE & CV7 not mechanically linked with contactor main contacts	Mutually unrestricted between all NO and NC contacts

## Terminals

Terminal Type				
Maximum Wire Size per IEC 947-1		2xA4	2xA4	2xA4
 Flexible with Wire-End	1 conductor [mm <sup>2</sup> ]	1...4	0.5...2.5	0.5...2.5
 Fernule	2 conductor [mm <sup>2</sup> ]	1...4	0.75...2.6	0.75...2.6
 Solid/Stranded-Conductor	1 conductor [mm <sup>2</sup> ]	1.5...6	0.5...2.5	0.5...2.5
	2 conductor [mm <sup>2</sup> ]	1.5...6	0.75...2.6	0.75...2.6
Recommended Tightening Torque	[Nm]	1.5...2.5	1...1.5	1...1.5
Max. Wire Size per UL/CSA	[AWG]	16...10	16...12	16...12
Recommended Tightening Torque	[lb-in]	13...22	8.9...13	8.9...13

## Accessories

<b>Latch Attachment Release, CV7-11</b>		
Coil Consumption	[VA/W]	AC 45/40
	[W]	DC 25W
<b>Contact Signal Duration</b>	[min/max]	0.03...15s
<b>Time Attachment, CRZE7, CRZA7</b>		
Reset Time		
at min. time setting	[ms]	10
at max. time setting	[ms]	70
Repeat Accuracy		±10%

## Contact Ratings (Per NEMA/UL A600 & Q600)

Standard	Circuit Voltage	Make (Amps/VA)	Break (Amps/VA)	Continuous Amps
A600	120AC	60A/7200VA	6A/720VA	10
	240AC	30A/7200VA	3A/720VA	
	480AC	15A/7200VA	1.5A/720VA	
	600AC	12A/7200VA	1.2A/720VA	
Q600	125DC	0.55A/69VA	0.55A/69VA	2.5
	250DC	0.27A/69VA	0.27A/69VA	
	301-600DC	0.1A/69VA	0.1A/69VA	

### Positively-Guided Contacts (Mechanically-linked)

SUVA Certified

- Restricted guidance guarantees without restrictions from contactor to auxiliary contact and auxiliary contact to contactor.●

● See Section G for additional details.

**Life-Load Curves**

- Locate the Rated Operational Current ( $I_g$ ) along the bottom of the chart and follow the graph lines up to the intersection of the appropriate contactor's life-load curve.
- Read the estimated contact life along the vertical axis.

Instructions on *How to* read Life Curves can be found on page A8

**AC-1**  
(to 690V)

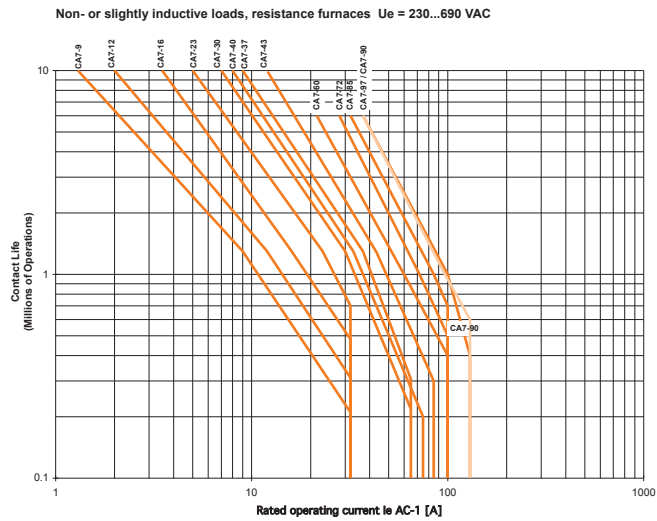

**AC-2**  
(to 460V)

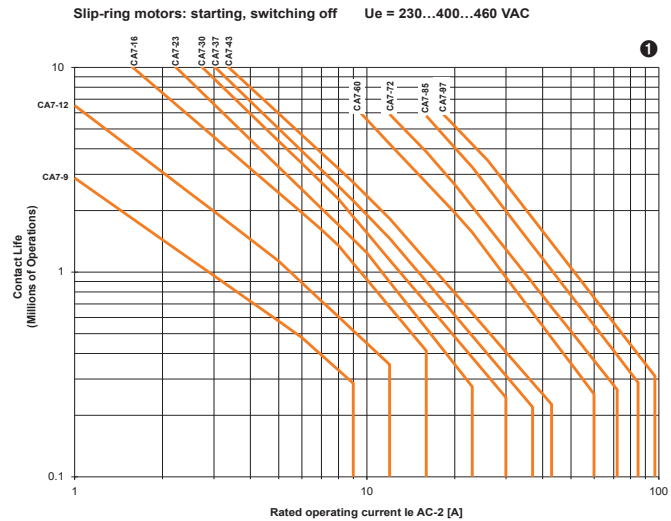

**AC-3**  
(to 460V)

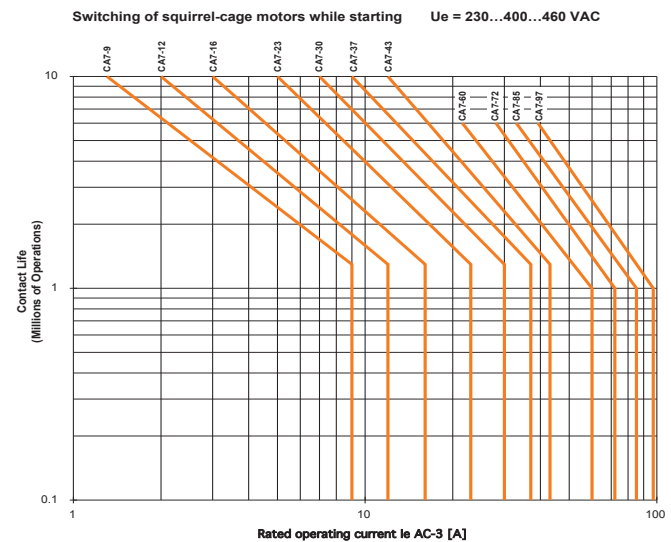

**NOTE:** The life-load curves shown here are based on Sprecher+Schuh tests according to the requirements defined in IEC 60947-4-1. Since contact life in any given application is dependent on environmental conditions and duty cycle, actual application contact life may vary from that indicated by the curves shown here.

① 575V applications use 90% of curve value.

**Life-Load Curves**

- Locate the Rated Operational Current ( $I_B$ ) along the bottom of the chart and follow the graph lines up to the intersection of the appropriate contactor's life-load curve.
- Read the estimated contact life along the vertical axis.

**AC-3**  
(to 575V)

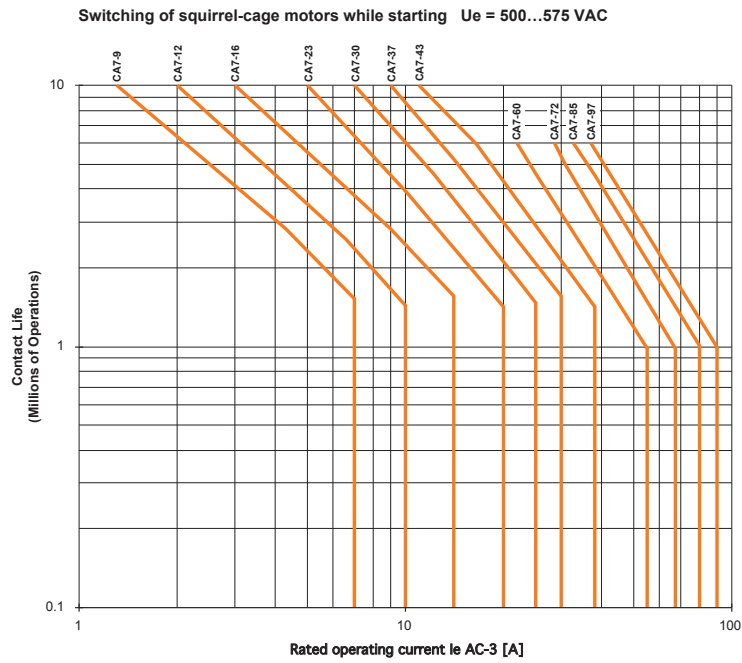

**AC-3**  
(to 690V)

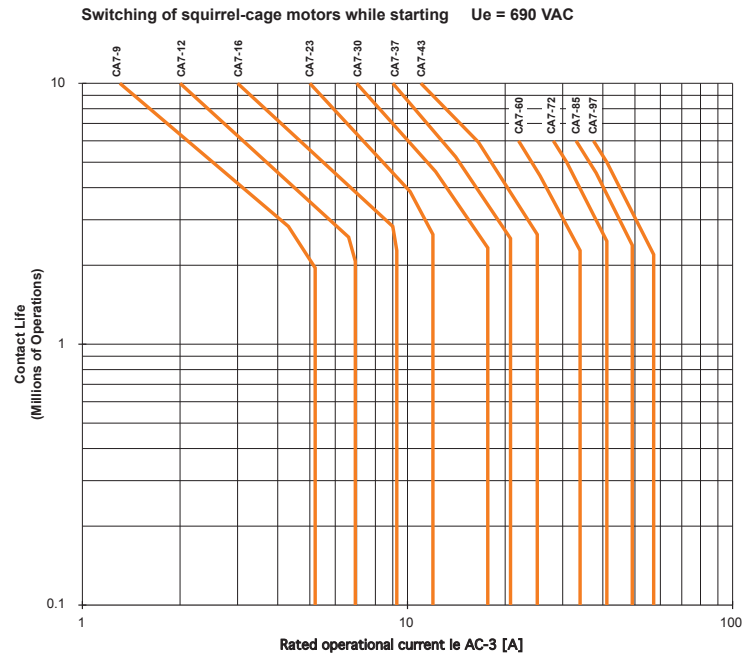

**NOTE:** The life-load curves shown here are based on Sprecher+Schuh tests according to the requirements defined in IEC 60947-4-1. Since contact life in any given application is dependent on environmental conditions and duty cycle, actual application contact life may vary from that indicated by the curves shown here.

**Life-Load Curves**

- Locate the Rated Operational Current ( $I_g$ ) along the bottom of the chart and follow the graph lines up to the intersection of the appropriate contactor's life-load curve.
- Read the estimated contact life along the vertical axis.

**AC-4**  
(to 460V)

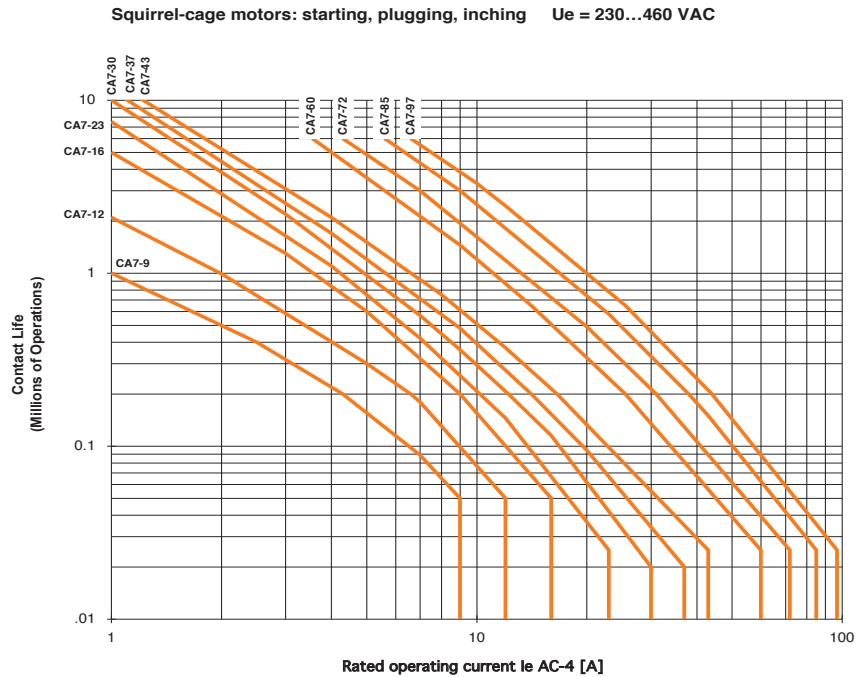

**AC-4**  
(to 690V)

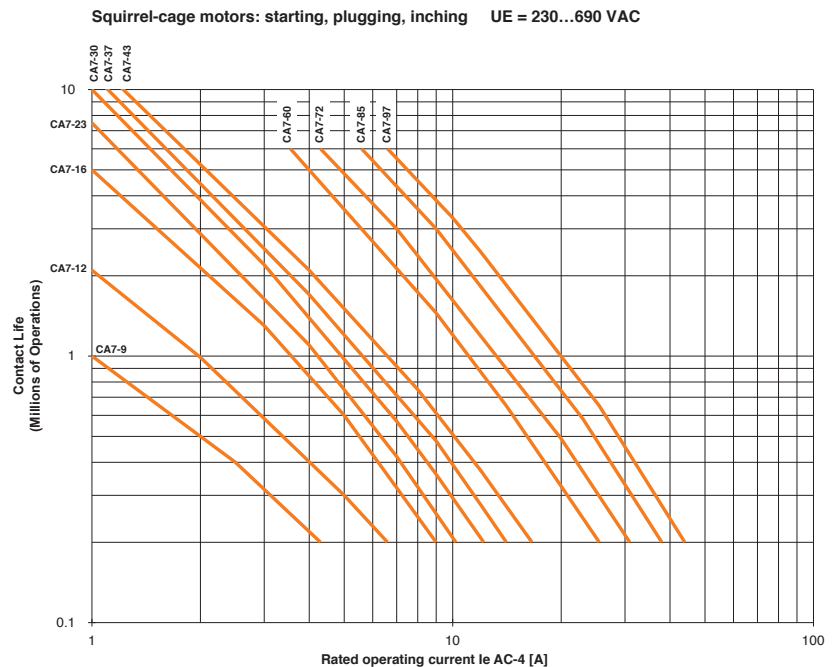

**NOTE:** The life-load curves shown here are based on Sprecher+Schuh tests according to the requirements defined in IEC 60947-4-1. Since contact life in any given application is dependent on environmental conditions and duty cycle, actual application contact life may vary from that indicated by the curves shown here.

**Contact Life for Mixed Utilization Categories AC-3 and AC-4**

In many applications, the utilization category cannot be defined as either purely AC-3 or AC-4. In those applications, the electrical life of the contactor can be estimated with the following equation:

$$L_{mixed} = L_{ac3} / [1 + P_{ac4} \times (L_{ac3} / L_{ac4} - 1)], \text{ where:}$$

$L_{mixed}$  Approximate contact life in operations for a mixed AC-3/AC-4 utilization category application.

$L_{ac3}$  Approximate contact life in operations for a pure AC-3 utilization category (from the AC-3 life-load curve).

$L_{ac4}$  Approximate contact life in operations for a pure AC-4 utilization category (from the AC-4 life-load curve).

$P_{ac4}$  Percentage of AC-4 operations

**AC-3 (90%),  
AC-4 (10%)**

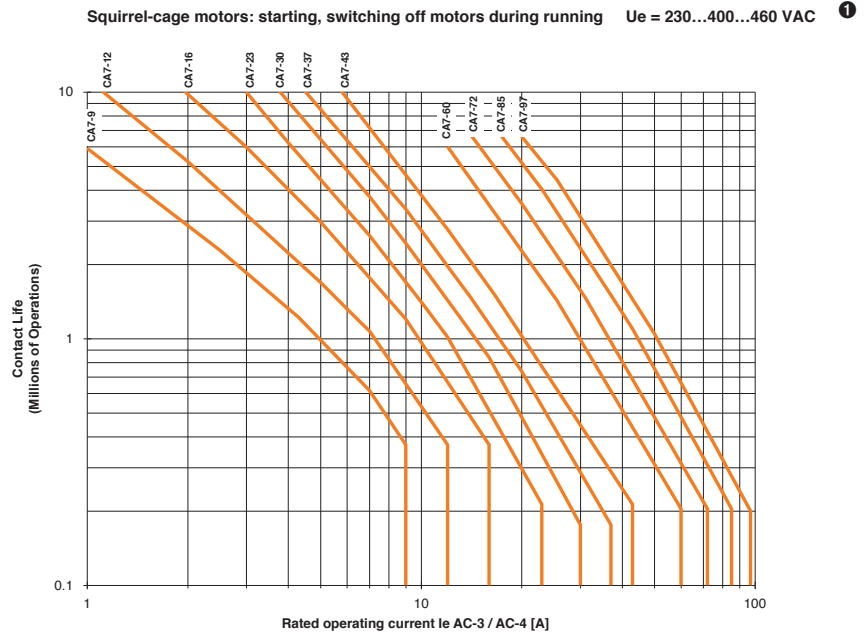

**AC-3 (75%),  
AC-4 (25%)**

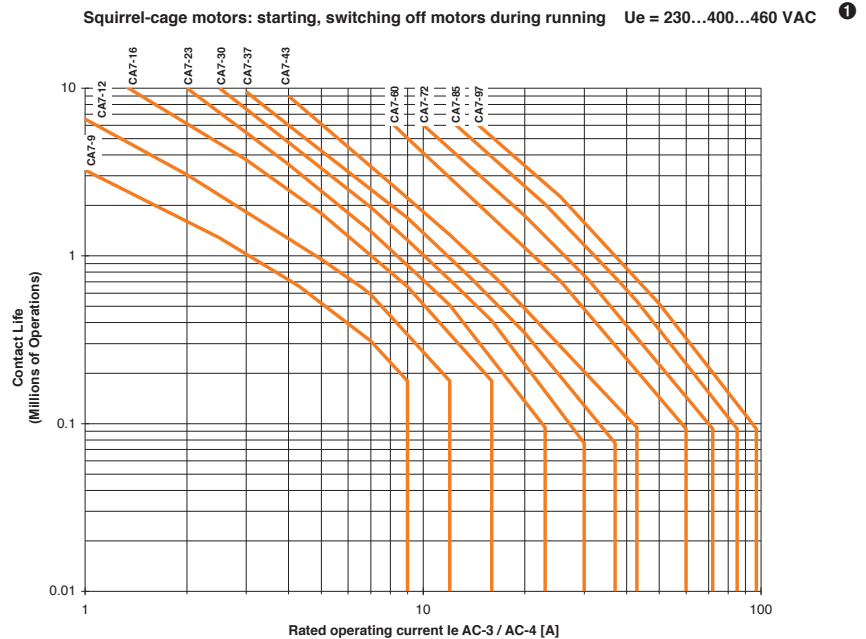

ⓘ 575V applications use 85% of curve value.



Contact Life for Special Applications

Heavy duty Starting and Regular Short-time Operation

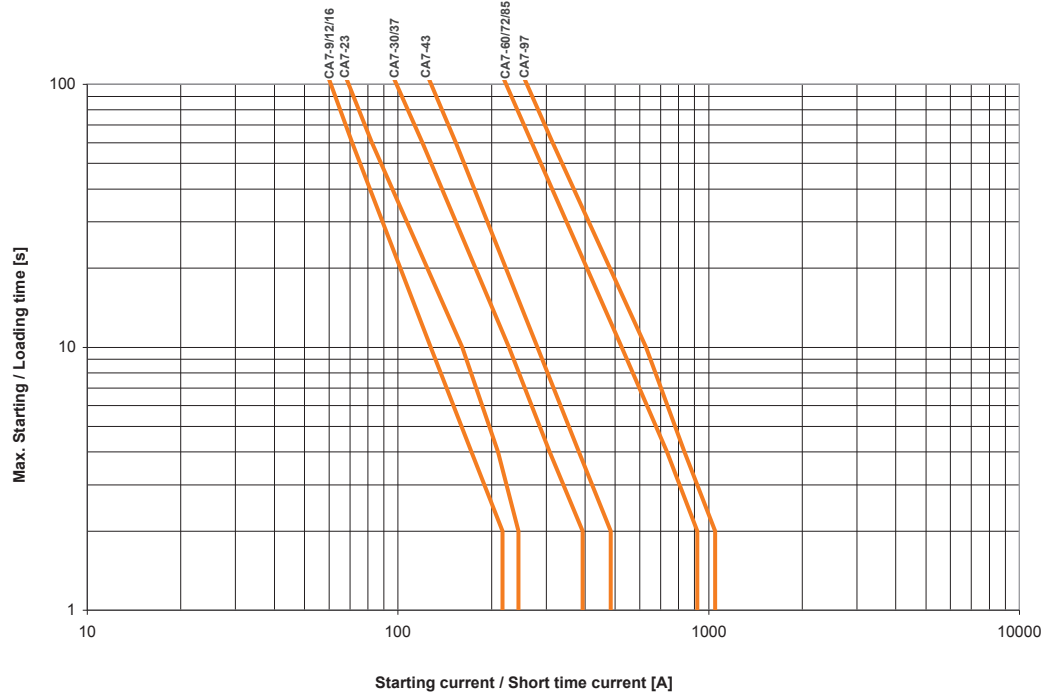

Short-time withstand current  $I_{cw}$  at 60°

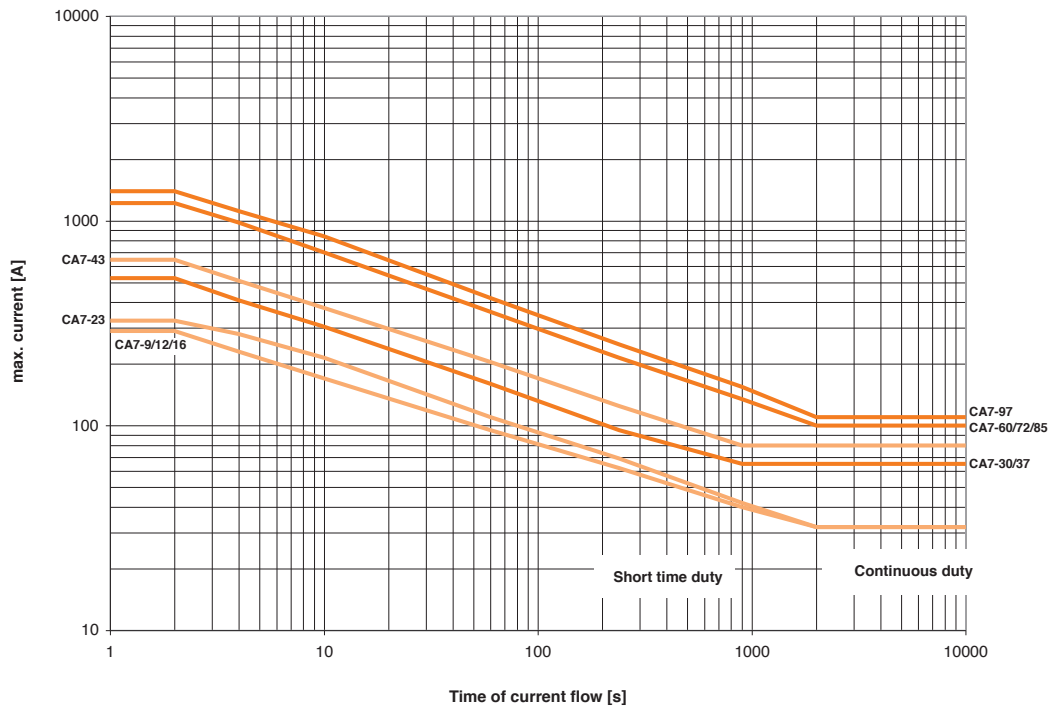

**A** **Operating Rates**

The estimated contact life shown in the life-load curves is based on the standard operating rates shown in Table B below. For applications requiring a higher operating frequency, the maximum operating power (Pn in kW or HP) for a given contactor must be reduced to maintain the same contact life.

To find a contactor’s maximum operating power, for an operating rate greater than shown in Table B, follow these guidelines:

1. Identify the appropriate curve for the contactor and utilization category from Table B.
  2. Locate the appropriate Maximum Operating Rate curve on the following pages.
  3. Locate the intersection of the curve with the application’s operating rate (ops/hr.) found on the vertical axis.
  4. Read the percent of maximum operating power (Pn) of the contactor from the horizontal axis.
  5. Multiply the % maximum power by the standard power rating.
- Example: The contactor selected for an AC-4 utilization category application is a CA7-16 (10HP at 460V), however, the application requires an operating rate of 200 ops/hr., compared to the standard operating rate of 120 ops/hr. as shown in Table B.
1. Locate the AC-4 Maximum Operating Rate curve on the following pages.
  2. Locate the intersection of 200 ops/hr on the CA7-16 curve. The data shows that the maximum operating power of the CA7-16 contactor in this application is 60%.
  3. Therefore, the maximum horsepower that can be switched by the CA7-16 contactor in this application is 6 HP (0.60 x 10HP).

**Table B – Standard Operating Rates by Contactor and Utilization Category**

Contactor	AC-1	AC-2	AC-3	AC-4	AC-4 @ I <sub>e</sub> for
	Max. ops/hr.	Max. ops/hr.	Max. ops/hr.	Max. ops/hr.	200K ops.
	Max. ops/hr.				
Operating Parameters and Start Time					
			40% Duty Cycle 250ms ❶	250ms	250ms
CA7-9	1000	500	700	200	400
CA7-12	1000	500	700	150	300
CA7-16	1000	500	700	120	240
CA7-23	1000	400	600	80	160
CA7-30	400	400	600	80	160
CA7-37	400	400	600	70	140
CA7-43	300	400	600	70	140
CA7-55	300	400	600	70	140
CA7-60	600	300	500	70	140
CA7-72	600	300	500	60	120
CA7-85	600	200	500	50	140
CA7-97	250	200	500	50	140

❶ Duty Cycle or Load Factor – Defined as the “on” time for a given operating cycle per hour including the “start time.” A 40% Duty Cycle is calculated in the following manner:

Contactor switches six (6) times per minute (tpm), 250ms start time; 40% duty cycle.

To determine the “on” time and “off” time:

- Operations per hour = 360; [60 min x 6 tpm = 360]
- One operating cycle = 10 sec; [60 min ÷ 6 tpm = 10 sec]
- “On” time at 40% duty cycle = 4 sec; [10 sec x 0.4 (40%) = 4 sec]
- 4 sec “on” time includes the start time of 250ms
- “Off” time at 40% duty cycle = 6 sec; [10 sec – 4 sec = 6 sec]

Operating Rate Curves

AC-1

Non- or slightly inductive loads, resistance furnaces U<sub>e</sub> = 230...690 VAC

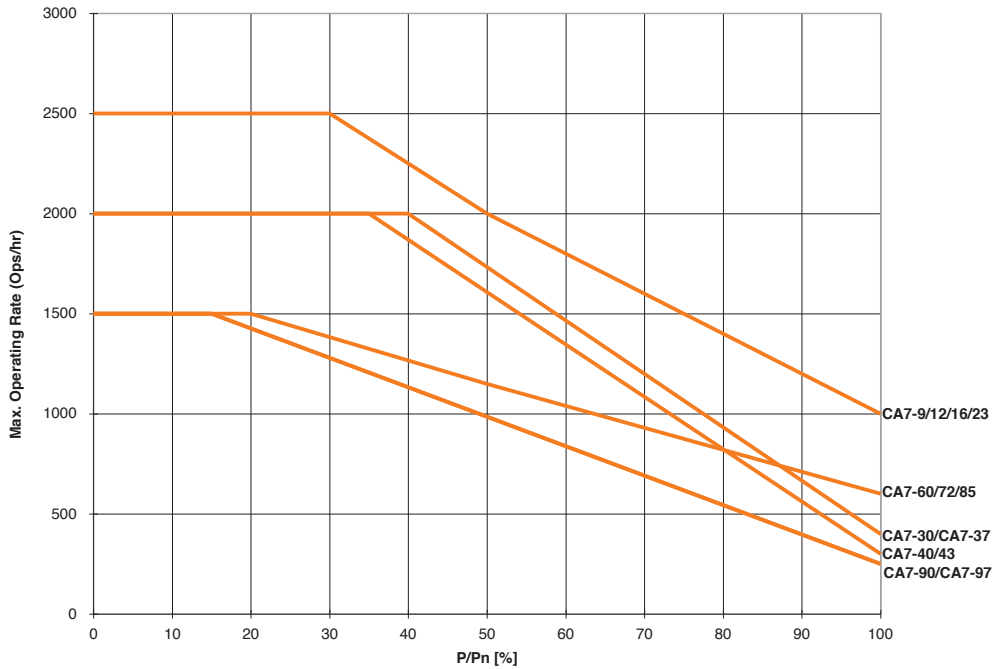

AC-2

Slip-ring motors: starting, switching off U<sub>e</sub> = 230...460 VAC

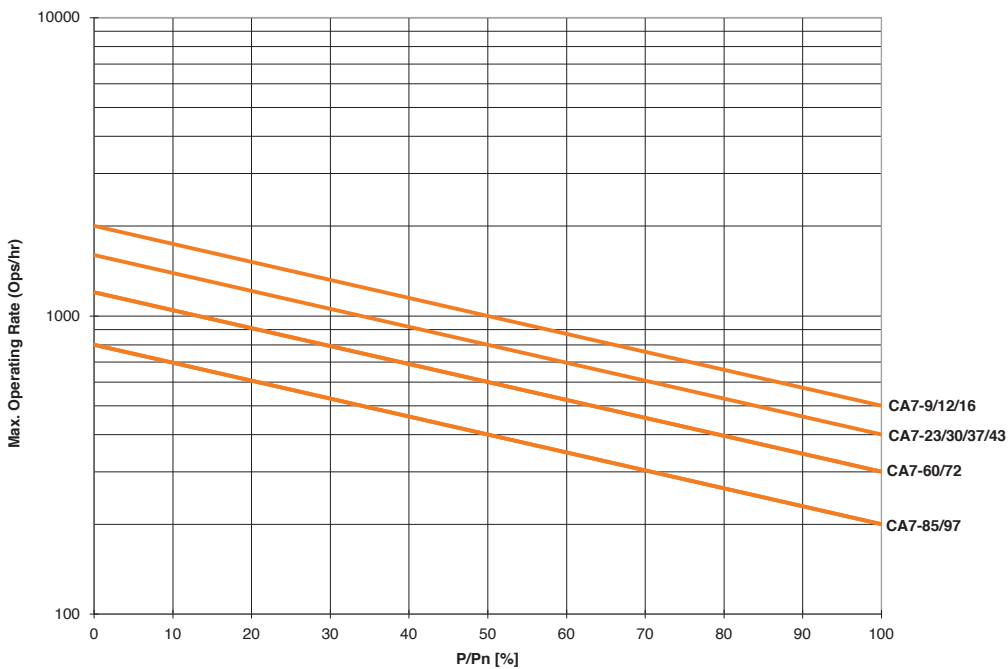

**A**

Operating Rate Curves

CA7 Contactors

AC-3

Squirrel-cage motors: starting, switching off motors during running  
250ms Start-up, 40% Duty Cycle  
Ue = 230...460VAC

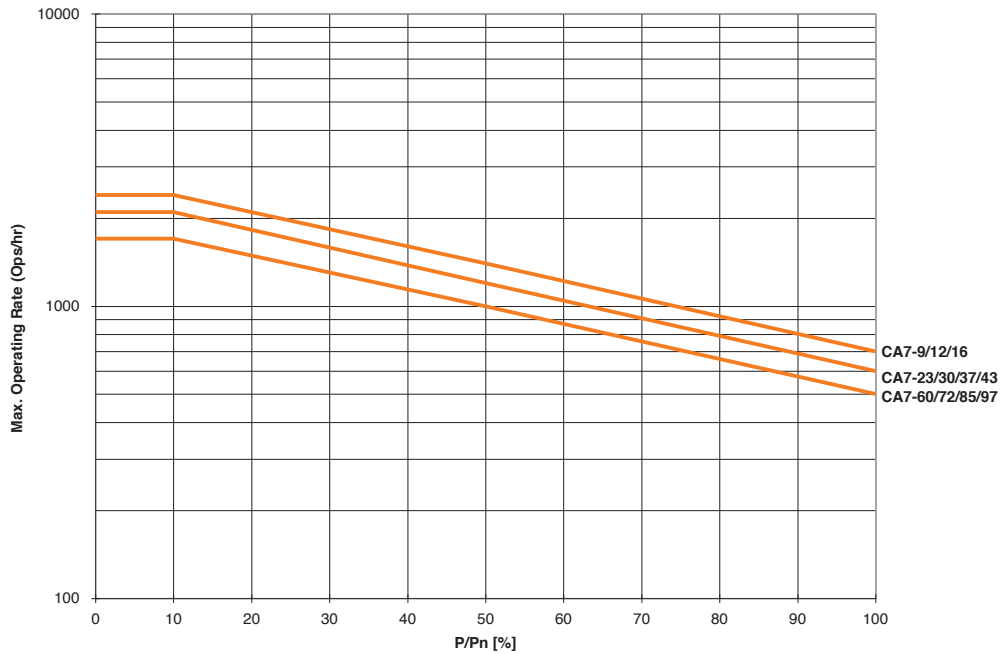

AC-4

Squirrel-cage motors: starting, plugging, inching  
250ms Start-up  
Ue=230...460VAC

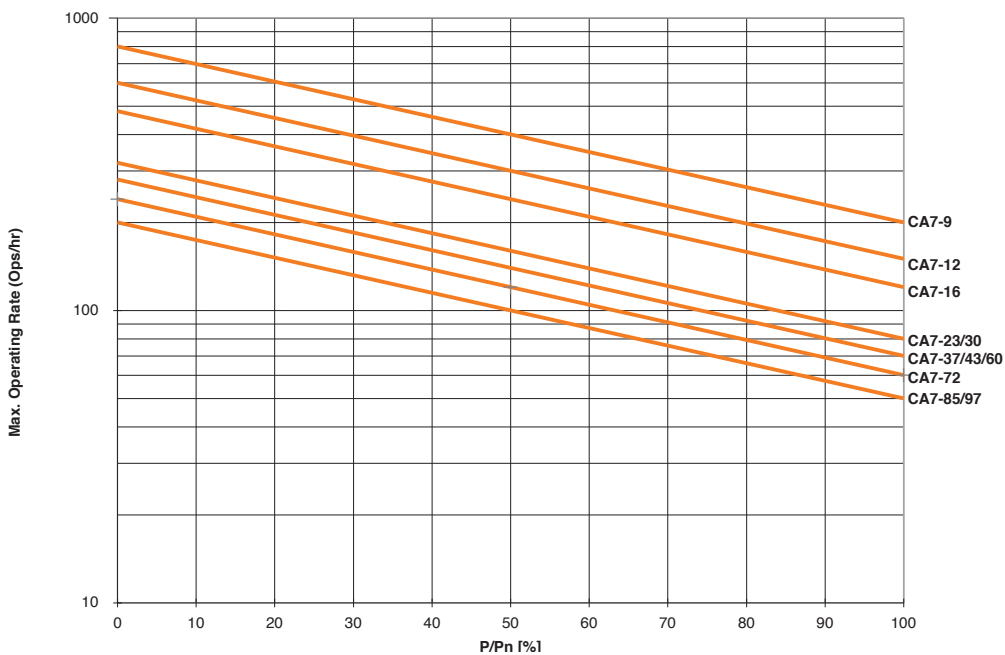

**Series CA7, CAU7, CNX, CAN7 and CAL7 (Contactors, Reversing Contactors & Special Use Contactors)**

Dimensions are in millimeters (inches). Dimensions not intended for manufacturing purposes.

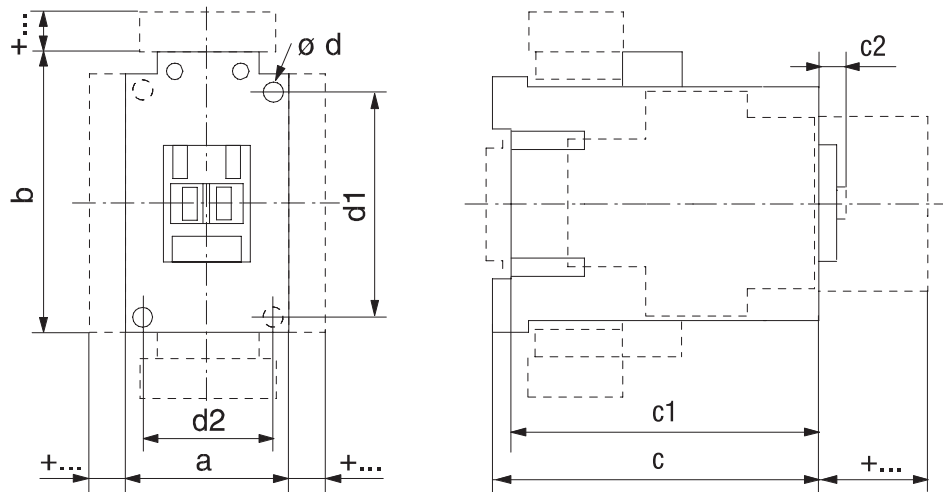

	Catalog Number	a	b	c	c1	c2	ød	d1	d2
AC Contactors	CA7-9...CA7-23; CAN7-12, CAN7-16, CNX-205...208; CA(V)L7-20	45 (1-25/32)	81 (3-3/16)	80.5 (3-11/64)	75.5 (3-3/32)	6 (1/4)	① 4.5 (3/16)	60 (2-23/64)	35 (1-25/64)
	CA7-30...CA7-37; CNX-209; CAN7-37	45 (1-25/32)	81 (3-3/16)	97.5 (4)	92.6 (3-49/64)	6.5 (17/64)	① 4.5 (3/16)	60 (2-23/64)	35 (1-25/64)
	CA7-40-M... CAL7-30-M40	59 (2-21/64)	81 (3-3/16)	100.5 (4-7/64)	95.5 (3-49/64)	6.5 (17/64)	① 4.5 (3/16)	60 (2-23/64)	45 (1-25/32)
	CA7-43...CA7-55, CAN7-43, CNX-212	54 (2-1/8)	81 (3-3/16)	100.5 (4-7/64)	95.5 (3-49/64)	6.5 (17/64)	① 4.5 (3/16)	60 (2-23/64)	45 (1-25/32)
	CA7-60...CA7-97, CAN7-85 CNX-218	72 (2-53/64)	122 (4-51/64)	117 (4-49/64)	111.5 (4-35/64)	8.5 (21/64)	② 5.4 (7/32)	100 (3-15/16)	55 (2-11/64)
	CA7-90-M... CAL7-60-M40	95 (3-3/4)	122 (4-51/64)	117 (4-49/64)	111.5 (4-35/64)	8.5 (21/64)	② 5.4 (7/32)	100 (3-15/16)	55 (2-11/64)

**Reversing Contactors, Capacitor Contactors & Accessories (+ ...)**

Contactors with...		Dim. [mm]	Dim. [inches]
auxiliary contact block-front mounting	2-, or 4-pole	c/c1 + 39	c/c1 + 1-37/64
auxiliary contact block-side mounting	1-, or 2-pole	a + 9	a + 23/64
pneumatic timing module		c/c1 + 58	c/c1 + 2-23/64
electronic timing module	on coil terminal side	b + 24	b + 15/16
reversing contactor w-mech.interlock	on side of contactor	a+9+a	a + 23/64+a
mechanical latch		c/c1 + 61	c/c1 + 2-31/64
interface module	on coil terminal side	b + 9	b + 23/64
surge suppressor	on coil terminal side	b + 3	b + 1/8
Labeling with...	label sheet	+0	+0
	marking tag sheet with clear cover	+0	+0
	marking tag adapter for V7 Terminals	+5.5	+7/32

**Mounting Position**

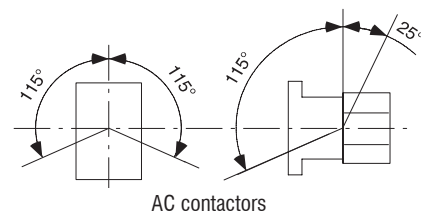

① 2 mounting holes.  
② 4 mounting holes.

### Series CA7 with Electronic DC Coil

Dimensions are in millimeters (inches). Dimensions not intended for manufacturing purposes.

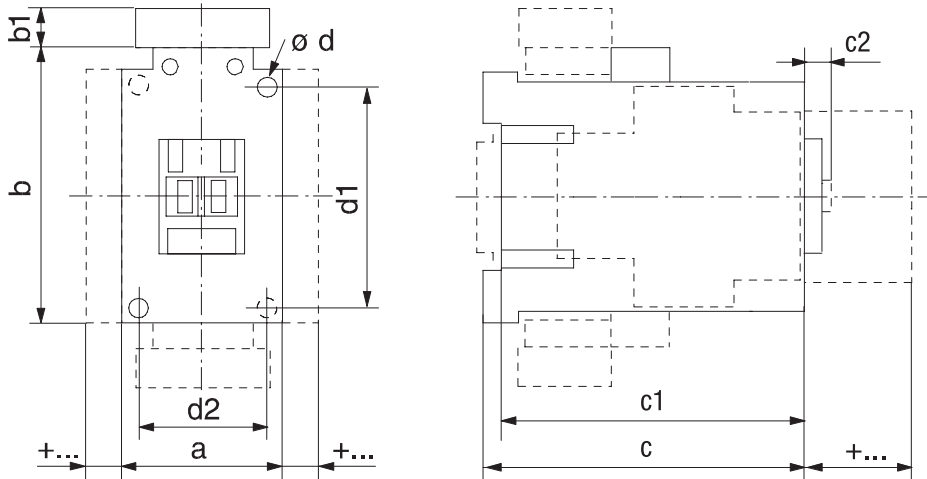

Catalog Number	Coil Code	a	b	b1	c	c1	c2	Ød	d1	d2
CA7-9E...CA7-23E, CAN7-12E...CAN7-16E	12E...24E	45 (1-25/32)	81 (3-3/16)	~	80.5 (3-11/64)	75.5 (2-31/32)	6 (15/64)	① 4.5 (3/16)	60 (2-23/64)	35 (1-3/8)
	36E...220E	45 (1-25/32)	81 (3-3/16)	24 (15/16)	80.5 (3-11/64)	75.5 (2-31/32)	6 (15/64)	① 4.5 (3/16)	60 (2-23/64)	35 (1-3/8)
CA7-30E...CA7-37E, CAN7-37E	12E...24E	45 (1-25/32)	81 (3-3/16)	~	97.5 (4)	92.5 (3-41/64)	6.5 (1/4)	① 4.5 (3/16)	60 (2-23/64)	35 (1-3/8)
	36E...220E	45 (1-25/32)	81 (3-3/16)	24 (15/16)	97.5 (4)	92.5 (3-41/64)	6.5 (1/4)	① 4.5 (3/16)	60 (2-23/64)	35 (1-3/8)
CA7-40E	12E...24E	59 (2-21/64)	81 (3-3/16)	~	100.5 (3-61/64)	95.5 (3-49/64)	6.5 (1/4)	① 4.5 (3/16)	60 (2-23/64)	45 (1-25/32)
	36E...220E	59 (2-21/64)	81 (3-3/16)	24 (15/16)	100.5 (3-61/64)	95.5 (3-49/64)	6.5 (1/4)	① 4.5 (3/16)	60 (2-23/64)	45 (1-25/32)
CA7-43E...55E, CAN7-43E	12E...24E	54 (2-1/8)	81 (3-3/16)	~	100.5 (3-61/64)	95.5 (3-49/64)	6.5 (1/4)	① 4.5 (3/16)	60 (2-23/64)	45 (1-25/32)
	36E...220E	54 (2-1/8)	81 (3-3/16)	24 (15/16)	100.5 (3-61/64)	95.5 (3-49/64)	6.5 (1/4)	① 4.5 (3/16)	60 (2-23/64)	45 (1-25/32)

### Reversing Contactors, Capacitor Contactors & Accessories (+...)

	Contactors with...	Dim. [mm]	Dim. [inches]
auxiliary contact block- front mounting	2-, or 4-pole	c/c1 + 39	c/c1 + 1-37/64
auxiliary contact block- left side mounting	1-, or 2 pole	a + 9	a + 23/64
pneumatic timing module		c/c1 + 58	c/c1 + 2-23/64
electronic timing module	on coil terminal side	b + 24	b + 15/16
mechanical latch		c/c1 + 61	c/c1 + 61
interface module	on coil terminal side	b + 9	c/c1 + 2-31/64
Labeling with...	label sheet	+0	+0
	marking tag sheet with clear cover	+0	+0
	marking tag adapter for V7 Terminals	+5.5	+7/32

### Mounting Position

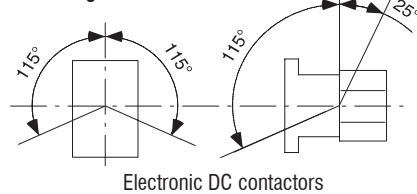

Electronic DC contactors

① 2 mounting holes.

**Series CA7 with Two Winding DC Coils**

Dimensions are in millimeters (inches). Dimensions not intended for manufacturing purposes.

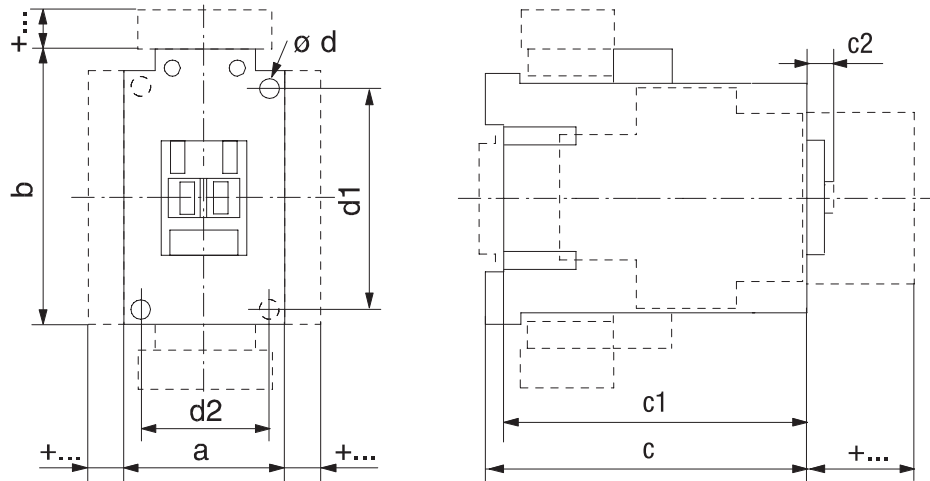

	Catalog Number	a	b	c	c1	c2	ød	d1	d2
Two Winding DC Contactors	CA7-60D...CA7-97D	72	122	117	111.5	8.5	① 5.4 (7/32)	100	55
	CAN7-85D	(2-53/64)	(4-51/64)	(4-49/64)	(4-35/64)	(21/64)		(3-15/16)	(2-11/64)
	CA7-90D	95	122	117	111.5	8.5	① 5.4 (7/32)	100	55
		(3-3/4)	(4-51/64)	(4-49/64)	(4-35/64)	(21/64)		(3-15/16)	(2-11/64)

**Reversing Contactors, Capacitor Contactors & Accessories (+...)**

	Contactors with...	Dim. [mm]	Dim. [inches]
	auxiliary contact block-front mounting	2-, or 4-pole	c/c1 + 39 c/c1 + 1-37/64
	auxiliary contact block- left side mounting	1-, or 2 pole	a + 9 a + 23/64
	pneumatic timing module		c/c1 + 58 c/c1 + 2-23/64
	electronic timing module	on coil terminal side	b + 24 b + 15/16
	mechanical latch		c/c1 + 61 c/c1 + 61
	interface module	on coil terminal side	b + 9 c/c1 + 2-31/64
Labeling with...	label sheet	+0	+0
	marking tag sheet with clear cover	+0	+0
	marking tag adapter for V7 Terminals	+5.5	+7/32

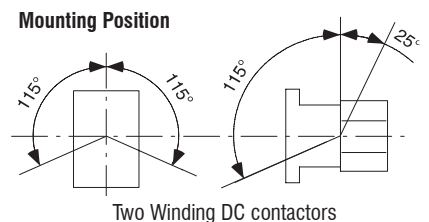

① 4 mounting holes.

**CA7 Contactors with Terminal Lugs**

Dimensions are in millimeters (inches). Dimensions not intended for manufacturing purposes.

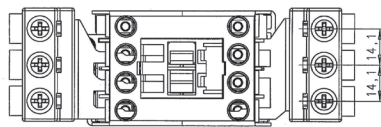
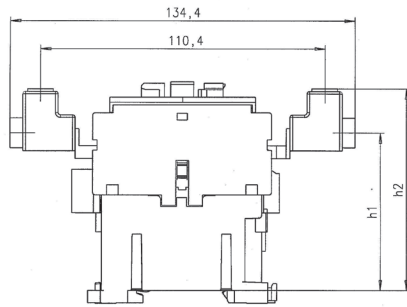

CA7-P-KN23 / KL23

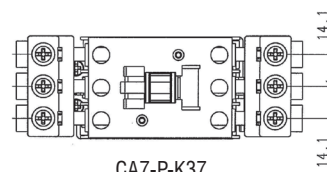
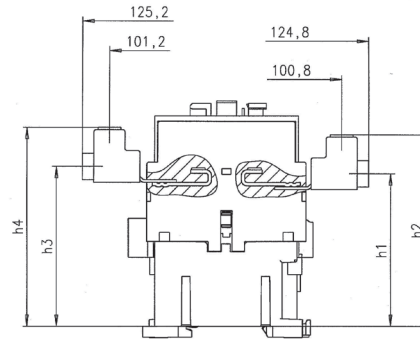

CA7-P-K37

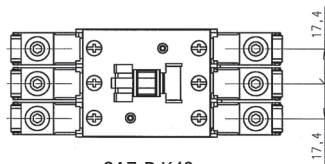
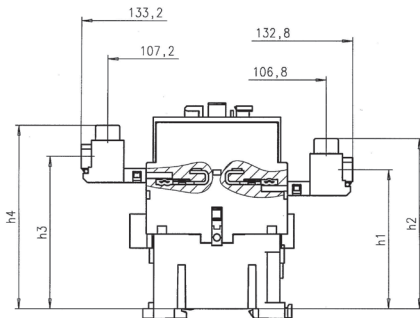

CA7-P-K43

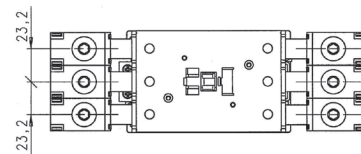
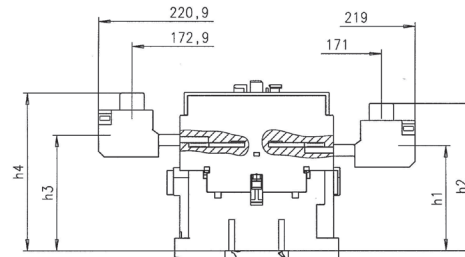

CA7-P-K85

Catalog Number	With Contactor	AC Operated Contactor				DC Operated Contactor			
		h1	h2	h3	h4	h1	h2	h3	h4
CA7-P-KN23 / KL23	CA7-9...16	61.6 (2-27/64)	78.6 (3-3/32)	~	~	87.2 (3-7/16)	104.2 (4-3/32)	~	~
	CA7-23	61.6 (2-27/64)	78.6 (3-3/32)	~	~	105.2 (4-9/64)	122.2 (4-13/16)	~	~
CA7-P-K37	CA7-30...37	67.6 (2-21/32)	84.6 (3-21/64)	71.5 (2-13/16)	88.5 (3-31/64)	111.2 (4-3/8)	128.2 (5-3/64)	115.1 (4-17/32)	132.1 (5-13/64)
CA7-P-K43	CA7-43...55	69.0 (2-23/32)	85.0 (3-11/32)	74.5 (2-15/16)	90.5 (3-9/16)	112.6 (4-7/16)	128.6 (5-1/16)	118.1 (4-21/32)	134.1 (5-9/32)
CA7-P-K85	CA7-60...97	79.7 (3-1/8)	104.7 (4-1/8)	86.7 (3-13/64)	111.7 (4-3/8)	79.7 (3-1/8)	104.7 (4-1/8)	86.7 (3-13/64)	111.7 (4-3/8)



**CA7 Contactors with Paralleling Links**

Dimensions are in millimeters (inches). Dimensions not intended for manufacturing purposes.

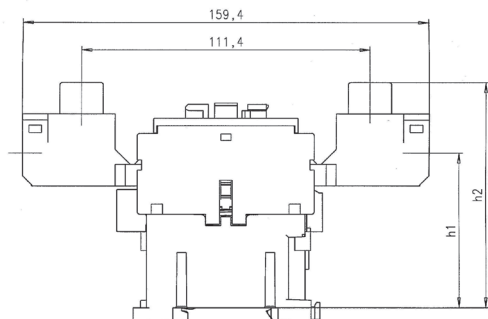

CA7-P-B23

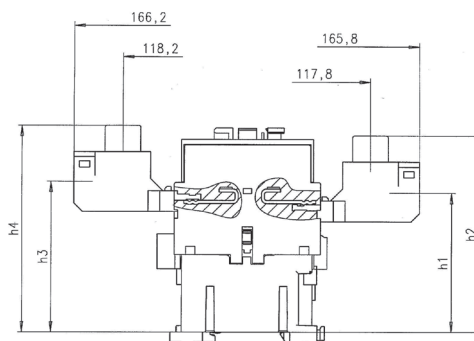

CA7-P-B37

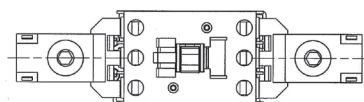
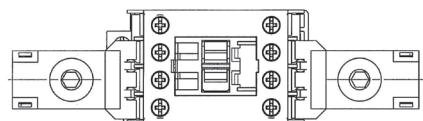

Catalog Number	With Contactor	AC Operated Contactor				DC Operated Contactor			
		h1	h2	h3	h4	h1	h2	h3	h4
<b>CA7-P-B23</b>	CA7-9...16	65.1 (2-9/16)	90.1 (3-9/16)	~	~	90.7 (1/4)	104.2 (2-3/16)	~	~
	CA7-23	65.1 (2-9/16)	90.1 (3-9/16)	~	~	108.7 (4-9/32)	133.7 (5-17/64)	~	~
<b>CA7-P-K37</b>	CA7-30...37	69.0 (2-23/32)	94.0 (3-45/64)	74.5 (2-15/16)	99.5 (3-29/32)	112.6 (4-7/16)	137.6 (5-13/32)	118.1 (4-21/32)	143.1 (5-5/8)

# Series CA9 Contactors

**NEW**

CA9 Contactors

The modern contactor for demanding applications up to 900HP (@460V) - up to 1150HP (@ 575V)

Sprecher + Schuh's CA9 contactor line combines the simple function of our popular CA7 series with the rugged performance demanded in this wide horsepower range. CA9 contactors offer a smaller footprint than traditional contactors in this size class.

## A broad selection for middle horsepower applications

The CA9 range consists of sixteen contactors in six frame sizes covering motors from 75 to 900HP at 460V and from 100 to 1150HP at 575V. This line is ideally suited for demanding applications such as steel mills, rock quarries, mines or for any middle horsepower application where a sturdy, durable contactor is needed.



## Rugged and reliable

CA9 contactors conform to UL508, IEC 60947 and can be operated at rated voltages up to 600V (UL) and 1000V (IEC). High thermal and switching capacities guarantee reliable operation and long life.

## Arc quenching extends contact life

All CA9 contactors are designed with sophisticated arc quenching techniques that extinguish damaging breaking arcs quickly. This is accomplished by guiding the arc away from the contacts and into "arc chambers", which are built-in to every CA9 cover.

## Safety first

CA9 arc chambers are completely enclosed (without arc exhaust vents), offering the best protection against hot arcing gases. A large safety distance in front of the contactor is unnecessary. CA9 contactors are also de-

signed so that operation is impossible if the arc chambers are removed. Conversely, once the contactor is energized, the arc chambers cannot be removed.

## Electronic coils offer many advantages

Behind the attractive outward appearance of the CA9 contactor are advanced engineering solutions that offer convenience and savings. The entire line is equipped with an electronically controlled coil that reduces pick-up currents by 80% on average. Holding current is also reduced.

Other advantages of the CA9 electronic coil include:

- Direct connection to a PLC. This is a standard feature in larger amp units and optional below 400A.
- Overvoltage protection and suppression circuits are standard, eliminating interference from the coil
- Smooth, even operation over the entire voltage range minimizes the possibility of contact bounce
- No safeguards are necessary to bridge brief supply interruptions
- Precisely defined pick-up and drop-out voltages, eliminate the possibility of chattering
- Universal Electronic coils operate over a much broader AC/DC voltage range, providing flexibility in applications and lower costs due to reduced inventory. Four coils cover six contactor frame sizes from 24-500V AC and 24-500V DC.

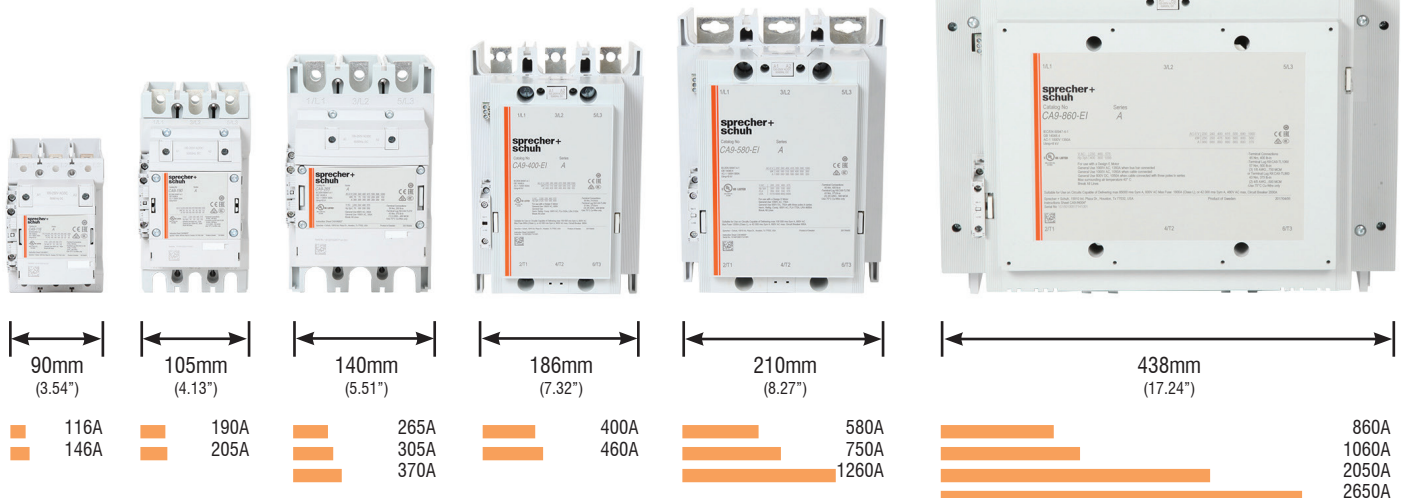

**Non-Reversing, Three Pole Contactors With AC/DC Coil, Series CA9 (Open type only) ①③**

I <sub>e</sub> [A]		Ratings for Switching AC Motors (AC2 / AC3)												Auxiliary Contacts per Contactor		Open Type
		kW (50 Hz)								UL/CSA HP (60 Hz)						
		220-240V	380-400V	415V	440V	500V	690V	1000V	3 Ø							
AC-3 (400V)	AC-1 (690V)							200V	230V	460V	575V	NO	NC	Catalog Number		
116	160	37	55	55	75	75	63	55	30	40	75	100	1	1	CA9-116-11-* <b>-L</b> ② CA9-116-EI-11-* <b>-L</b> ②	
146	225	45	75	75	90	90	90	75	40	50	100	125	1	1	CA9-146-11-* <b>-L</b> ② CA9-146-EI-11-* <b>-L</b> ②	
190	275	55	90	90	110	110	132	110	50	60	125	150	1	1	CA9-190-11-* CA9-190-EI-11-*	
205	350	55	110	110	132	132	160	132	60	75	150	200	1	1	CA9-205-11-* CA9-205-EI-11-*	
265	400	75	132	132	160	160	200	160	75	100	200	250	1	1	CA9-265-11-* CA9-265-EI-11-*	
305	500	90	160	160	160	200	250	185	100	125	250	300	1	1	CA9-305-11-* CA9-305-EI-11-*	
370	600	110	200	200	200	250	315	200	125	150	300	350	1	1	CA9-370-11-* CA9-370-EI-11-*	
400	600	110	200	220	220	250	315	220	125	150	350	400	1	1	CA9-400-EI-11-*	
460	700	132	250	250	250	315	355	280	150	200	400	500	1	1	CA9-460-EI-11-*	
580	800	160	315	355	355	400	500	355	200	250	500	600	1	1	CA9-580-EI-11-*	
750	1050	220	400	425	450	530	600	400	250	300	600	700	1	1	CA9-750-EI-11-*	
860	1350	250	475	500	560	630	800	555	~	400	800	1000	1	1	CA9-860-EI-11-*	
1060	1650	315	560	630	710	710	1000	600	~	450	900	1150	1	1	CA9-1060-EI-11-*	
~	1260	~	~	~	~	~	~	~	~	~	~	~	1	1	CA9-1260-EI-11-*	
~	2050	~	~	~	~	~	~	~	~	~	~	~	1	1	CA9-2050-EI-11-*	
~	2650	~	~	~	~	~	~	~	~	~	~	~	1	1	CA9-2650-EI-11-*	

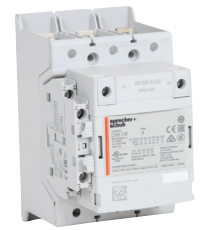

CA9-116 contactor



CA9-400-EI contactor



CA9-860-EI contactor

- CA9\_-EI coils are electronically controlled coils with the following characteristics:
- Ability to connect directly to a low level signal source such as a PLC ~15VDC (6mA) to 33VDC (20mA)
  - Very low pull-in and holding current for contactors in this size class
  - Threshold voltages for pull-in and drop-out are very precisely defined, eliminating "chattering"
  - Supply voltage dips are bridged without extra equipment

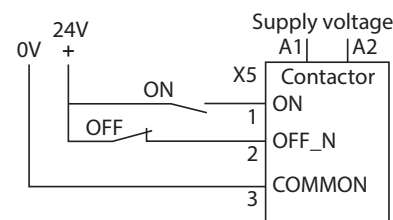

PLC Interface "EI" connection

**Coil Codes**

Electronic Coils	V	24-60V	48-130V	100-250V	250-500V
CA9-116...370	AC/DC	24W	48W	120W	480W
CA9-116-EI...370-EI	AC/DC with PLC Input	~	~	120W	480W
CA9-400-EI...750-EI		24W ④	48W	120W	480W
CA9-860-EI...1060-EI		~	~	120W	~
CA9-1260-EI		24W ④	48W	120W	480W
CA9-2050-EI...2650-EI		~	~	120W	~

**Note:** CA9-190...2650 open-type contactors include terminal bolts. If lugs are required, see page A94 for ordering information.

**Ordering Instructions**

Specify Catalog Number	
Replace (*) with Coil Code	See Coil Codes on this page

- ① "-EI" designates contactor coil with PLC input. Selections CA9-116...370 with "EI" requires use of control logic on terminals 1, 2, 3. CA9-400 contactors and larger include an integral switch to select use of "EI".
- ② CA9-116(-EI)...146(-EI) include terminal lugs. To order with terminal bolts remove the letter "-L" at the end of the catalog number. For example CA9-116(-EI)-11-\***-L** becomes CA9-116(-EI)-11-\*. List Price reduction applies.
- ③ For UL/CSA Elevator duty rating, consult Technical Information on page A103.
- ④ Coil is rated 24V...60V DC only.

CA9 Contactors

### Reversing, Three Pole Contactors With AC/DC Coil, Series CA9 (Open type only) ①②

I <sub>e</sub> [A]		Ratings for Switching AC Motors (AC2 / AC3)											Auxiliary Contacts per Contactor		Open Type
		kW (50 Hz)							UL/CSA HP (60 Hz)						
AC-3 (400V)	AC-1 (690V)	220-240V	380-400V	415V	440V	500V	690V	1000V	3 Ø				NO	NC	Catalog Number
									200V	230V	460V	575V			
116	160	37	55	55	75	75	63	55	30	40	75	100	1	1	CAU9-116-22-* <b>-L</b> ⑤ CAU9-116-EI-22-* <b>-L</b> ⑥
146	225	45	75	75	90	90	90	75	40	50	100	125	1	1	CAU9-146-22-* <b>-L</b> ⑤ CAU9-146-EI-22-* <b>-L</b> ⑥
190	275	55	90	90	110	110	132	110	50	60	125	150	1	1	CAU9-190-22-* CAU9-190-EI-22-*
205	350	55	110	110	132	132	160	132	60	75	150	200	1	1	CAU9-205-22-* CAU9-205-EI-22-*
265	400	75	132	132	160	160	200	160	75	100	200	250	1	1	CAU9-265-22-* CAU9-265-EI-22-*
305	500	90	160	160	160	200	250	185	100	125	250	300	1	1	CAU9-305-22-* CAU9-305-EI-22-*
370	600	110	200	200	200	250	315	200	125	150	300	350	1	1	CAU9-370-22-* CAU9-370-EI-22-*
400	600	110	200	220	220	250	315	220	125	150	350	400	1	1	CAU9-400-EI-22-*
460	700	132	250	250	250	315	355	280	150	200	400	500	1	1	CAU9-460-EI-22-*
580	800	160	315	355	355	400	500	355	200	250	500	600	1	1	CAU9-580-EI-22-*
750	1050	220	400	425	450	530	600	400	250	300	600	700	1	1	CAU9-750-EI-22-*



CAU9-190 Reversing Contactor

#### Includes:

- Mechanical and electrical Interlock
- Reversing power wiring (using Power Wiring Kit Cat.# CA9-PW...) ③
- Mounting plate (when required)
- Control wiring available; see footnote ④

Larger sizes are possible. Contact your Sprecher + Schuh representative.

CA9-...EI coils are electronically controlled coils with the following characteristics:

- Ability to connect directly to a low level signal source such as a PLC ~15VDC (6mA) to 33VDC (20mA)
- Very low pull-in and holding current for contactors in this size class
- Threshold voltages for pull-in and drop-out are very precisely defined, eliminating "chattering"
- Supply voltage dips are bridged without extra equipment

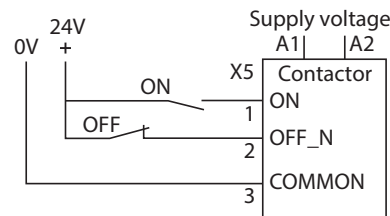

PLC Interface "EI" connection

### Coil Codes

Electronic Coils	V	24-60V	48-130V	100-250V	250-500V
CA9-116...370	AC/DC	24W	48W	120W	480W
CA9-116-EI...370-EI	AC/DC with PLC Input	~	~	120W	480W
CA9-400-EI...750-EI		24W ⑤	48W	120W	480W
CA9-860-EI...1060-EI		~	~	120W	~
CA9-1260-EI		24W ⑤	48W	120W	480W
CA9-2050-EI...2650-EI		~	~	120W	~

**Note:** CA9-190...2650 open-type contactors include terminal bolts. If lugs are required, see page A94 for ordering information.

### Ordering Instructions

Specify Catalog Number	
Replace (*) with Coil Code	See Coil Codes on this page

- ① "-EI" designates contactor coil with PLC input. Selections CA9-116...370 with "EI" requires use of control logic on terminals 1, 2, 3. CA9-400 contactors and larger include an integral switch to select use of "EI".
- ② For UL/CSA Elevator duty rating, consult Technical Information on page A103.
- ③ For Reversing Contactors *without* power wiring add suffix "**-LW**" to catalog number. For example: CAU9-116-22-\* becomes CAU9-116-22-\***-LW**. Control wiring is not included. List Price reduction applies.
- ④ For control wiring, add suffix **-CW** to catalog number. For example: CAU9-116-22-\* becomes CAU9-116-22-\***-CW**. List price adder applies.
- ⑤ Coil is rated 24V...60V DC only.
- ⑥ CAU9-116(-EI)...146(-EI) include terminal lugs. To order with terminal bolts remove the letter "L" at the end of the catalog number. For example CAU9-116(-EI)-22-\***-L** becomes CAU9-116(-EI)-22-\*. List price reduction applies

**Hydraulic Elevator Wye Delta, with AC Coils (Two Contactor Type ①)**

UL/CSA ELEVATOR DUTY				Auxiliary Contacts per Contactor		Open Type
200V	230V	460V	575V	NO	NC ②	Catalog No.
54 15	54 20	54 40	54 50	1	1	CA9Y2-116-22-* <b>LW</b> ⑤ CA9Y2-116-EI-22-* <b>LW</b> ⑤
54 15	54 20	54 40	54 50	1	1	CA9Y2-146-22-* <b>LW</b> ⑤ CA9Y2-146-EI-22-* <b>LW</b> ⑤
77 20	77 25	77 60	77 75	1	1	CA9Y2-190-22-* <b>LW</b> CA9Y2-190-EI-22-* <b>LW</b>
99 30	99 30	99 75	99 100	1	1	CA9Y2-205-22-* <b>LW</b> CA9Y2-205-EI-22-* <b>LW</b>
125 40	125 40	125 100	125 125	1	1	CA9Y2-265-22-* <b>LW</b> CA9Y2-265-EI-22-* <b>LW</b>
149 40	149 50	149 100	149 150	1	1	CA9Y2-305-22-* <b>LW</b> CA9Y2-305-EI-22-* <b>LW</b>
156 50	156 60	156 125	156 150	1	1	CA9Y2-370-22-* <b>LW</b> CA9Y2-370-EI-22-* <b>LW</b>

**Selection**

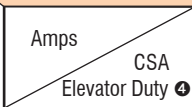

CA9Y2-116 Wye-Delta contactor

**Includes:**

- Mechanical and electrical Interlocks ②
- Mounting plate

CA9 “EI” coils are electronically controlled coils with the following characteristics:

- Ability to connect directly to a low level signal source such as a PLC ~15VDC (6mA) to 33 VDC (20mA)
- Very low pull-in and holding current for contactors in this size class
- Threshold voltages for pull-in and drop-out are very precisely defined, eliminating “chattering”
- Supply voltage dips are bridged without extra equipment

**Coil Codes**



Electronic Coils	V	24-60V	48-130V	100-250V	250-500V
CA9-116...370	AC/DC	24W	48W	120W	480W
CA9-116-EI...370-EI	AC/DC with PLC Input	~	~	120W	480W

**Ordering Instructions**

Specify Catalog Number	
Replace (*) with Coil Code	<b>See Coil Codes on this page.</b>

- ① “-EI” designates contactor coil with PLC input. Selections CA9-116...370 with “EI” requires use of control logic on terminals 1, 2, 3. CA9-400 contactors and larger include an integral switch to select use of “EI”.
- ② One NC auxiliary contact on each contactor is used for electrical interlocking.
- ③ Other voltages available, see page A96.
- ④ HP selection based on CSA Elevator Duty Ratings.
- ⑤ CA9Y2-116(-EI)...146(-EI) include terminal lugs.

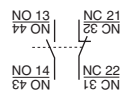
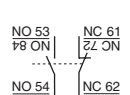
**Auxiliary Contact Blocks**

Auxiliary Contact Blocks	Description	NO	NC	Contact Arrangement	For use with...	Catalog Number
	<b>Auxiliary Contact Block for Side Mounting</b> <ul style="list-style-type: none"> <li>• 2-Pole</li> <li>• Two-way numbering for right or left mounting</li> <li>• Easy mounting without tools</li> <li>• Mirror contact performance to main contactor poles</li> <li>• Low power switching down to 24V 50mA</li> </ul>	1	1		CA9-116...370 Inside left or right	<b>CA9-S1-11</b>
		1	1		CA9-400...2650 Inside left or right	<b>CA9-S3-11</b>
	<b>Low Power Auxiliary Contact Block for Side Mounting</b> <ul style="list-style-type: none"> <li>• 1-Pole</li> <li>• Two-way numbering for right or left mounting</li> <li>• Easy mounting without tools</li> <li>• Mirror contact performance to main contactor poles</li> <li>• Electronic compatible, 3V 1mA</li> </ul>	1	0		CA9-116...370 Inside left or right	<b>CA9-S1-B10</b> ①
		0	1		CA9-400...2650 Inside left or right	<b>CA9-S3-B01</b> ①

**NOTE:** Up to four auxiliary contact blocks (8 poles) may be mounted on the side of the CA9 contactor. One auxiliary contact block (1 NO + 1 NC) is mounted at the factory (inside left position).

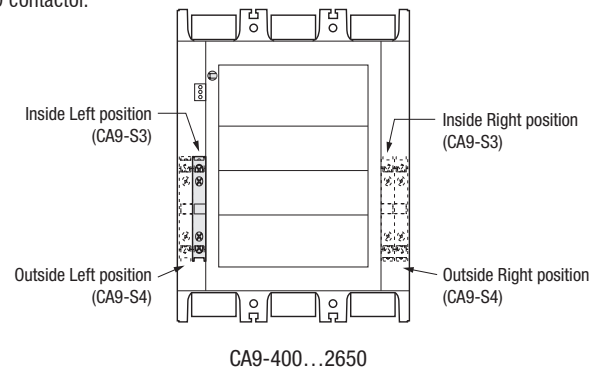
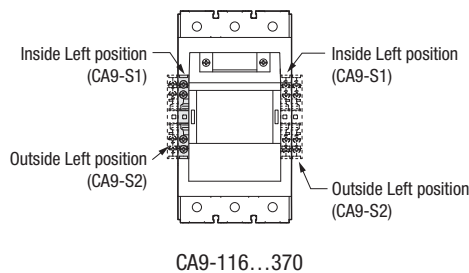

**Mechanical Interlocks**

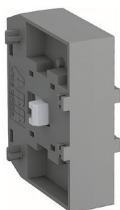
Accessory	Description	For use with...	Catalog Number
	<ul style="list-style-type: none"> <li>• Mechanical only, without auxiliary contacts</li> <li>• Interlocking of two same size contactors</li> </ul>	CA9-116...CA9-370	<b>CA9-M1-00</b>
		CA9-400...750, CA9-1260 ②	<b>CA9-M2-00</b>
		CA9-860...1060, CA9-2050...2650 ③	<b>CA9-M3-00</b>
	<ul style="list-style-type: none"> <li>• Mechanical only, without auxiliary contacts</li> </ul>	CA9-116...146 to CA9-190...205	<b>CA9-M4-00</b>
		CA9-190...205 to CA9-265...370	<b>CA9-M5-00</b>
<ul style="list-style-type: none"> <li>• Rod for vertical mounting reversing contactors</li> </ul>	CA9-400...750	<b>CA9-VR750</b>	

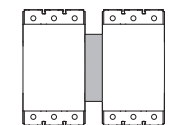

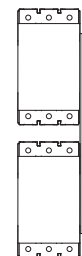

Horizontal mechanical interlock CA9-M\_00



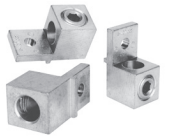
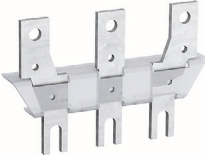

Vertical mechanical interlock CA9-VR750

- ① Contact blocks cannot be mounted on the outside of CA9-S1-B\* or CA9-S3-B\*.
- ② Mounting plate ordered separately.
- ③ Mounting plate included.

### Terminal Lugs and Accessories

Lug or Accessory	Connection	Wire Sizes	For use with...	Catalog Number
 <p>Order 1 Pkg for 2 kits</p>	<b>Terminal Lug Kit -</b> <ul style="list-style-type: none"> <li>Standard for CA9-116-_-L...146-_-L</li> <li>Includes 2 sets, one for Line side and one for Load Side</li> </ul>	2 x 6 AWG...3/0 AWG	CA9-116(-EI)...146(-EI)	<b>CA9-CL146</b>
 <p>Order 1 Pkg for 3 lugs</p>	<b>Terminal Lugs ①</b> <ul style="list-style-type: none"> <li>Includes 1 set of 3 lugs for use on either Line or Load Side.</li> <li>Order qty of 2 for both.</li> </ul>	6 AWG...300 MCM	CA9-190(-EI)...205(-EI)	<b>CA9-TL205</b>
		4 AWG...400 MCM	CA9-265(-EI)...370(-EI)	<b>CA9-TL370</b>
		2 x 4 AWG...500 MCM	CA9-265(-EI)...370(-EI)	<b>CA9-TL370B</b>
		3 x 2/0 AWG...500 MCM	CA9-400-EI...460-EI	<b>CA9-TL580</b>
		2 x 2/0 AWG...500 MCM	CA9-580-EI...750-EI	<b>CA9-TL750</b>
		4 x 4/0 AWG...500 MCM	CA9-860-EI	<b>CA9-TL860</b>
		4 x 1/0 AWG...750 MCM	CA9-1060-EI	<b>CA9-TL1060</b>
	<b>Terminal Enlargements ②</b> <ul style="list-style-type: none"> <li>Enlargement pieces designed to increase the width of the contactor terminal pads in order to allow larger connections to be mounted</li> </ul>		CA9-116(-EI)...146(-EI)	<b>CA9-TE146</b>
			CA9-190(-EI)...205(-EI)	<b>CA9-TE205</b>
			CA9-265(-EI)...370(-EI)	<b>CA9-TE370</b>
			CA9-400-EI...460-EI	<b>CA9-TE460</b>
			CA9-580-EI...750-EI	<b>CA9-TE750</b>
			CA9-1260-EI	<b>CA9-TE1260</b>
	<b>Terminal Extensions</b> <ul style="list-style-type: none"> <li>Extension pieces designed to extend the main terminals of contactors for combined mounting of contactors and connection sets</li> </ul>		CA9-116(-EI)...146(-EI)	<b>CA9-TX146</b>
			CA9-190(-EI)...205(-EI)	<b>CA9-TX205</b>
			CA9-265(-EI)...370(-EI)	<b>CA9-TX370</b>
			CA9-400-EI...460-EI	<b>CA9-TX460</b>
		CA9-580-EI...750-EI	<b>CA9-TX750</b>	

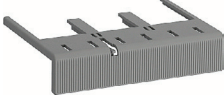
### Terminal Shrouds

Accessory	Description	For use with...	Catalog Number
	For contactors with Compression Lugs <ul style="list-style-type: none"> <li>Package contains 2 shrouds, one for Line and one for Load side</li> <li>Not applicable when using CA9-PW-power wiring kits.</li> </ul>	CA9-116(-EI)...146(-EI)	<b>CA9-TS146L</b>
		CA9-190(-EI)...205(-EI)	<b>CA9-TS205C</b>
		CA9-265(-EI)...370(-EI)	<b>CA9-TS370C</b>
		CA9-400-EI...460-EI	<b>CA9-TS460C</b>
		CA9-580-EI...750-EI, 1260-EI	<b>CA9-TS750C</b>
	For contactors with Terminal Lugs <ul style="list-style-type: none"> <li>Package contains 2 shrouds, one for Line and one for Load side</li> <li>Not applicable when using CA9-PW-power wiring kits.</li> </ul>	CA9-190(-EI)...205(-EI)	<b>CA9-TS205L</b>
		CA9-265(-EI)...370(-EI)	<b>CA9-TS370L ③</b>
		CA9-400-EI...460-EI	<b>CA9-TS460L</b>
		CA9-580-EI...750-EI	<b>CA9-TS750L</b>
	For IP20 protection between contactor and overload relay on a non-reversing starter	CAT9-116(-EI)...146(-EI)	<b>CA9-TC146</b>
		CAT9-190(-EI)...205(-EI)	<b>CA9-TC205</b>
	For IP20 protection between contactor and overload relay on a reversing starter	CAUT9-116(-EI)...146(-EI)	<b>CA9-TCR146</b>
		CAUT9-190(-EI)...205(-EI)	<b>CA9-TCR205</b>

- ① Contactors CA9-1260...2650 are intended for busbar connection only. Lugs should be sourced separately and are not available from Sprecher + Schuh
- ② Not applicable with CA9-TL370B dual lugs.
- ③ Not applicable with CA9-TL\_\_\_ lugs. The intention for landing a wire is using compression (ring) lugs.

See page A109 for terminal wire ranges.

**Power Wiring Connection Kits**

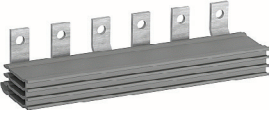
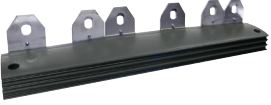
Connection Kits	Application	For use with...		Catalog Number
 <p>CA9-PW146</p>  <p>CA9-PWD460</p>	Reversing Power Wiring Kits	CA9-116(-EI)...146(-EI)		CA9-PW146
		CA9-190(-EI)...205(-EI)		CA9-PW205 ①
		CA9-265(-EI)...370(-EI)		CA9-PW370 ①
		CA9-400-EI...460-EI		CA9-PW460 ②
		CA9-580-EI...750-EI		CA9-PW750 ②
	Wye-Delta Power Wiring Kits	Delta Contactor	Wye Contactor	
		CA9-116(-EI)...146(-EI)	CA9-116(-EI)...146(-EI)	CA9-PWD146
		CA9-190(-EI)...205(-EI)	CA9-116(-EI)...146(-EI)	CA9-PWD190
		CA9-190(-EI)...205(-EI)	CA9-190(-EI)...205(-EI)	CA9-PWD205
		CA9-265(-EI)...370(-EI)	CA9-190(-EI)...205(-EI)	CA9-PWD265
		CA9-265(-EI)...370(-EI)	CA9-265(-EI)...370(-EI)	CA9-PWD370
		CA9-400-EI...460-EI	CA9-400-EI...460-EI	CA9-PWD460
		CA9-580-EI...750-EI	CA9-400-EI...460-EI	CA9-PWD580
	CA9-580-EI...750-EI	CA9-580-EI...750-EI	CA9-PWD750	
	Shorting Bar	CA9-116(-EI)...146(-EI)		CA9-PWY146
CA9-190(-EI)...205(-EI)		CA9-PWY205		
CA9-265(-EI)...370(-EI)		CA9-PWY370		
CA9-400-EI...460-EI		CA9-PWY460		
CA9-580-EI...750-EI		CA9-PWY750		

**Mounting Plates (For CA9-116...750 Contactors)**

Application	Description	For use with...	Catalog Number
	Non-Reversing Starters	CA9-116(-EI)...146(-EI)	CA9-MS146
		CA9-190(-EI)...205(-EI)	CA9-MS205
	Reversing Contactors	CA9-116(-EI)...146(-EI)	CA9-MR146
		CA9-190(-EI)...205(-EI)	CA9-MR205
		CA9-265(-EI)...370(-EI)	CA9-MR370
		CA9-400-EI...460-EI	CA9-MR460
		CA9-580-EI...750-EI	CA9-MR750
	Reversing Starters	CA9-116(-EI)...146(-EI)	CA9-MRS146
		CA9-190(-EI)...205(-EI)	CA9-MRS205

- ① Power wiring kit includes one set of terminal extensions CA9-TX\_ . If terminal lugs CA9-TL\_ are to be used on line and load side of reversing contactor, a second set of CA9-TX\_ terminal extensions is required.
- ② If terminal lugs CA9-TL\_ are to be used on the line and load side of reversing contactor, two sets of terminal extensions CA9-TX\_ are also required (none included).



### Renewal Coils - AC/DC, Electronic Coil

Electronic Coil <i>(typical)</i>	For use with...	Voltage	Coil Code	Catalog Number
 <p>Replacement Coil without EI Interface includes coil and cover</p>	CA9-116	24-60V AC/DC	24W	CA9-TG913
		48-130V AC/DC	48W	CA9-TG914
		100-250V AC/DC	120W	CA9-TG915
		250-500V AC/DC	480W	CA9-TG916
	CA9-116-EI	100-250V AC/DC w/ PLC Interface	120W	CA9-TGE913
		250-500V AC/DC w/ PLC Interface	480W	CA9-TGE914
	CA9-146	24-60V AC/DC	24W	CA9-TG901
		48-130V AC/DC	48W	CA9-TG902
		100-250V AC/DC	120W	CA9-TG903
		250-500V AC/DC	480W	CA9-TG904
	CA9-146-EI	100-250V AC/DC w/ PLC Interface	120W	CA9-TGE903
		250-500V AC/DC w/ PLC Interface	480W	CA9-TGE904
	CA9-190 CA9-205	24-60V AC/DC	24W	CA9-TG905
		48-130V AC/DC	48W	CA9-TG906
		100-250V AC/DC	120W	CA9-TG907
		250-500V AC/DC	480W	CA9-TG908
CA9-190-EI	100-250V AC/DC w/ PLC Interface	120W	CA9-TGE915	
	250-500V AC/DC w/ PLC Interface	480W	CA9-TGE916	
CA9-205-EI	100-250V AC/DC w/ PLC Interface	120W	CA9-TGE907	
	250-500V AC/DC w/ PLC Interface	480W	CA9-TGE908	
CA9-265...370	24-60V AC/DC	24W	CA9-TG909	
	48-130V AC/DC	48W	CA9-TG910	
	100-250V AC/DC	120W	CA9-TG911	
	250-500V AC/DC	480W	CA9-TG912	
CA9-265-EI	100-250V AC/DC w/ PLC Interface	120W	CA9-TGE917	
	250-500V AC/DC w/ PLC Interface	480W	CA9-TGE918	
CA9-305-EI	100-250V AC/DC w/ PLC Interface	120W	CA9-TGE919	
	250-500V AC/DC w/ PLC Interface	480W	CA9-TGE920	
CA9-370-EI	100-250V AC/DC w/ PLC Interface	120W	CA9-TGE911	
	250-500V AC/DC w/ PLC Interface	480W	CA9-TGE912	
CA9-400-EI, CA9-460-EI	24-60V DC	24W	CA9-THE901	
	48-130V AC/DC	48W	CA9-THE902	
	100-250V AC/DC	120W	CA9-THE903	
	250-500V AC/DC	480W	CA9-THE904	
CA9-580...750-EI, CA9-1260-EI	24-60V DC	24W	CA9-TJE901	
	48-130V AC/DC	48W	CA9-TJE902	
	100-250V AC/DC	120W	CA9-TJE903	
	250-500V AC/DC	480W	CA9-TJE904	
CA9-860-EI...1060-EI, CA9-2050-EI	100-250V AC/DC	120W	CA9-TKE903 ❶	
			CA9-TKE904 ❷	
CA9-2650-EI	100-250V AC/DC	120W	CA9-TLE903 ❶	
			CA9-TLE904 ❷	

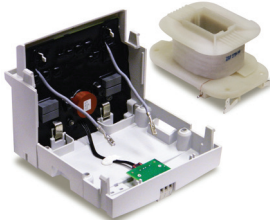

❶ One set of two (2) coils.  
❷ Printed circuit board.

**Renewal Contact Kits and Arc Chutes**

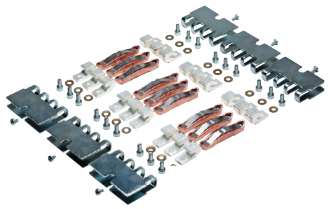
	Description	For use with...	Catalog Number
	Contact Kits	CA9-116(-EI)	CA9-A116
		CA9-146(-EI)	CA9-A146
		CA9-190(-EI)	CA9-A190
		CA9-205(-EI)	CA9-A205
		CA9-265(-EI)	CA9-A265
		CA9-305(-EI)	CA9-A305
		CA9-370(-EI)	CA9-A370
		CA9-400-EI	CA9-A400
		CA9-460-EI	CA9-A460
		CA9-580-EI	CA9-A580
		CA9-750-EI	CA9-A750
		CA9-860-EI	CA9-A860
		CA9-1060-EI	CA9-A1060
		CA9-1260-EI	CA9-A1260
		CA9-2050-EI	CA9-A2050
	CA9-2650-EI	CA9-A2650 ❶	
	Arc Chutes	CA9-400-EI...460-EI	CA9-C460
		CA9-580-EI...750-EI, CA9-1260-EI	CA9-C750
		CA9-860-EI...1060-EI, CA9-2050-EI	CA9-C1060
		CA9-2650-EI	CA9-C2650

**Replacement Terminal Hardware**

	Description	For use with...	Catalog Number
	Standard Screws and Washers	CA9-116...146(-EI)...-L	CA9-HS146 ❷
		CA9-116...146(-EI)	CA9-HF146
		CA9-190...205(-EI)	CA9-HF205
		CA9-265...370(-EI)	CA9-HF370
		CA9-400...460-EI	CA9-HF460
		CA9-580, 750, 1060-EI	CA9-HF750
		CA9-2050-EI	CA9-HF2050
		CA9-2650-EI	CA9-HF2650

❶ Movable contacts only.  
❷ Mounting hardware only.

CA9 Contactors

#### Contactors Cross Reference, Series CA1 & CA6 to Series CA9 (Open Type Only) ①

I <sub>e</sub> [A]		Ratings for Switching AC Motors (AC2 / AC3 / AC4)										Series CA1 Obsolete Catalog Number	Series CA6 Obsolete Catalog Number	Series CA9 Equivalent Catalog Number
		kW (50 Hz)				UL/CSA HP (60 Hz)								
		AC-3	AC-1	230V	400V / 415V	500V	690V	1 Ø		3 Ø				
115V	230V							200V	230V	460V	575V			
115	250	37	64/66	80	111	10	25	40	40	75	100		CA6-115	
116	160	30	55	75	55			30	40	75	100			CA9-116
						10	25	40	40	75	100	CA1-60		
140	250	45	78/82	80	111	15	30	40	50	100	125		CA6-140	
146	225	45	75	90	90			40	50	100	125			CA9-146
						15	30	50	50	100	125	CA1-100		
180	250	57	101/105	98	135	~	40	50	60	150	150		CA6-180	
190	275	55	90	90	132			50	60	125	150			CA9-190
						~	~	60	60	150	150	CA1-150		
205	350	55	110	110	160			60	75	150	200			CA9-205
210	350	67	118/122	147	205	~	50	60	75	150	200		CA6-210	
						~	~	75	100	200	250	CA1-250		
250	350	80	140/145	177	250	~	~	75	100	200	250		CA6-250	
265	400	75	132	160	200			75	100	200	250			CA9-265
300	450	97	170/176	213	293	~	~	100	125	250	300		CA6-300	
305	500	90	160	200	250			100	125	250	300			CA9-305
						~	~	150	150	350	400	CA1-480		
400	600	110	200/220	250	315			125	150	350	400			CA9-400
420	500	135	238/250	298	424	~	~	150	175	350	400		CA6-420	
460	700	132	250	315	355			150	200	400	500			CA9-460
580	800	160	315/355	400	500			200	250	500	600			CA9-580
630	800	200	355	450	500	~	~	200	250	500	600		CA6-630	
750	1050	220	400/425	520	600			250	300	600	700			CA9-750
860	1000	250	500	560	~	~	~	250	300	600	700		CA6-860	
860	1350	257	475/500	560	800			~	400	800	1000			CA9-860



CA1-10  
Contactor



CA6-140-EI contactor

① Available auxiliary contacts may vary. See selection pages for more information.

## General Data

CA9-116...2650		
<b>Rated Isolation Voltage <math>U_i</math></b>		
IEC	[V]	1000V
UL; CSA	[V]	600V
<b>Rated Voltage <math>U_{mp}</math></b>	(kV)	8
<b>Rated Voltage <math>U_c</math> - Main Contacts</b>		
AC 50/60Hz	[V]	115,200,230,240,400,415,460,500,575,690,1000
DC	[V]	24, 48, 110, 220, 440
<b>Operating Frequency for AC Loads</b>	[Hz]	50/60Hz
<b>Electromagnetic compatibility</b>	IEC 60947-1 - Environment A	
<b>Insulation Class of the Coil</b>	Class F per IEC 60947-4-1	
<b>Rated Coil Frequency</b>	AC 50/60 Hz, DC	
<b>Ambient Temperature</b>		
Storage	[°C]	-40...+70
Operation at rated voltage	[°C]	-40...+70
<b>Max. Altitude of Installation Site</b>	[m]	3000
<b>Climatic Withstand</b>		
CA9-116...370:	IEC 60068-2-30 Test Db & IEC 60068-2-2 test Bd & IEC 60068-2-1 test Ab (report 1314369)	
CA9-400...2650:	IEC 60068-2-2 test Ba & Bb & IEC 60068-2-1 test Aa & Ab, IEC 60068-2-30	
<b>Resistance to Shock</b>	IEC 60068-2-27	
<b>Resistance to Vibration</b>	IEC 60068-2-6	
<b>Protection Class</b>		
Contactor main contacts	IP00	
Contactor coil terminals	P2X (in connected state)	
Auxiliary contacts	P2X (in connected state)	

<b>Standards</b>	IEC/EN 60947-1, Low-voltage switch gear and control gear; IEC/EN 60947-4-1, Low-voltage switch gear and control gear, Contactors and motor starters; IEC/EN 60947-5-1, Low-voltage switch gear and control gear, Control circuit devices and switching elements; UL 60947-4-1, Industrial Control Equipment (USA); CSA C22.2 No. 14, Industrial Control Equipment (Canada) Mechanically Linked Contacts: IEC 60947-5-1, Annex L
	Mirror Contacts: IEC 60947-4-1, Annex F CA9-116...750 with all CA9-S* side mounted NC auxiliary contacts
<b>Approvals</b>	cULus, File No. E41850/E196120 (contactors, reversing contactors) CCC, EAC, RINA, ABS, RCM
<b>Certifications</b>	CE, SUVA

**Electrical Data, Main Circuits**

Coil Type:	Electronic	CA9-116	CA9-146	CA9-190	CA9-205	CA9-265	CA9-305	CA9-370	CA9-400	CA9-460	CA9-580	CA9-750	CA9-860	CA9-1060	CA9-1260	CA9-2050	CA9-2650		
<b>Switching of 3-phase Motors; (50Hz)</b>																			
Ambient temperature 60°C, AC-2, AC-3	220-240V	[A]	116	146	190	205	265	305	370	400	460	580	750	860	1060	~	~	~	
	380-400V	[A]	116	146	190	205	265	305	370	400	460	580	750	860	1060	~	~	~	
	415V	[A]	116	146	190	205	265	305	370	400	460	580	750	860	1060	~	~	~	
	440V	[A]	116	146	190	205	265	305	370	400	460	580	750	860	1060	~	~	~	
	500V	[A]	110	130	156	185	250	290	350	400	460	580	750	800	970	~	~	~	
	690V	[A]	66	93	135	165	250	290	315	350	400	500	650	800	970	~	~	~	
	1000V	[A]	46	60	85	100	113	131	141	155	200	250	300	375	400	~	~	~	
	220-240V	[kW]	37	45	55	55	75	90	110	110	132	160	220	250	315	~	~	~	
	380-400V	[kW]	55	75	90	110	132	160	200	200	250	315	400	475	560	~	~	~	
	415V	[kW]	55	75	90	110	132	160	200	220	250	355	425	500	630	~	~	~	
	440V	[kW]	75	90	110	132	160	160	200	220	250	355	450	560	710	~	~	~	
	500V	[kW]	75	90	110	132	160	200	250	250	315	400	530	630	710	~	~	~	
	690V	[kW]	63	90	132	160	200	250	315	315	355	500	600	800	1000	~	~	~	
	1000V	[kW]	55	75	110	132	160	185	200	220	280	355	400	555	600	~	~	~	
	<b>Load Carrying Capacity per cULus</b>																		
	General Purpose Current (enclosed)		[A]	160	200	250	300	350	400	520	550	650	750	900	1350	1650	1210	2100	2700
	Rated Operational Current and Power (enclosed), 3-Phase	200V	[A]	92	120	150	177	221	285	359	359	414	552	692	954	1030	~	~	~
230V		[A]	104	130	154	192	248	312	360	360	480	604	722	954	1030	~	~	~	
460V		[A]	96	124	156	180	240	302	361	414	477	590	722	954	1030	~	~	~	
575V		[A]	99	125	144	192	242	289	336	382	472	578	672	944	1050	~	~	~	
200V		[HP]	30	40	50	60	75	100	125	125	150	200	250	~	~	~	~	~	
230V		[HP]	40	50	60	75	100	125	150	150	200	250	300	400	450	~	~	~	
460V		[HP]	75	100	125	150	200	250	300	350	400	500	600	800	900	~	~	~	
575V		[HP]	100	125	150	200	250	300	350	400	500	600	700	1000	1150	~	~	~	
260V DC		[A]	160	200	~	~	~	~	~	~	~	~	~	~	~	~	~	~	
Rated Current (enclosed), with 3 poles in series		300V DC	[A]	~	~	230	250	~	~	~	~	~	~	~	~	~	~	~	
	340V DC	[A]	~	~	~	~	350	400	520	~	~	~	~	~	~	~	~		
	600V DC	[A]	~	~	~	~	~	~	~	500	650	750	900	1050	1350	1210	1900		

**Electrical Data, Main Circuits**

Coil Type:	Electronic	CA9-116	CA9-146	CA9-190	CA9-205	CA9-265	CA9-305	CA9-370	CA9-400	CA9-460	CA9-580	CA9-750	CA9-860	CA9-1060	CA9-1260	CA9-2050	CA9-2650	
<b>Switching of 3-phase Motors; (50Hz)</b>																		
Ambient temperature	220-240V	[A]	116	146	190	205	265	305	370	400	460	580	750	860	1060	~	~	~
60°C, AC-2, AC-3	380-400V	[A]	116	146	190	205	265	305	370	400	460	580	750	860	1060	~	~	~
	415V	[A]	116	146	190	205	265	305	370	400	460	580	750	860	1060	~	~	~
	440V	[A]	116	146	190	205	265	305	370	400	460	580	750	860	1060	~	~	~
	500V	[A]	110	130	156	185	250	290	350	400	460	580	750	800	970	~	~	~
	690V	[A]	66	93	135	165	250	290	315	350	400	500	650	800	970	~	~	~
	1000V	[A]	46	60	85	100	113	131	141	155	200	250	300	375	400	~	~	~
	220-240V	[kW]	37	45	55	55	75	90	110	110	132	160	220	250	315	~	~	~
	380-400V	[kW]	55	75	90	110	132	160	200	200	250	315	400	475	560	~	~	~
	415V	[kW]	55	75	90	110	132	160	200	220	250	355	425	500	630	~	~	~
	440V	[kW]	75	90	110	132	160	160	200	220	250	355	450	560	710	~	~	~
500V	[kW]	75	90	110	132	160	200	250	250	315	400	530	630	710	~	~	~	
690V	[kW]	63	90	132	160	200	250	315	315	355	500	600	800	1000	~	~	~	
1000V	[kW]	55	75	110	132	160	185	200	220	280	355	400	555	600	~	~	~	
<b>Load Carrying Capacity per cULus</b>																		
General Purpose Current (enclosed)	[A]	160	200	250	300	350	400	520	550	650	750	900	1350	1650	1210	2100	2700	
	200V	[A]	92	120	150	177	221	285	359	359	414	552	692	954	1030	~	~	~
	230V	[A]	104	130	154	192	248	312	360	360	480	604	722	954	1030	~	~	~
	460V	[A]	96	124	156	180	240	302	361	414	477	590	722	954	1030	~	~	~
Rated Power (enclosed),	575V	[A]	99	125	144	192	242	289	336	382	472	578	672	944	1050	~	~	~
3-Phase	200V	[HP]	30	40	50	60	75	100	125	125	150	200	250	~	~	~	~	~
	230V	[HP]	40	50	60	75	100	125	150	150	200	250	300	400	450	~	~	~
	460V	[HP]	75	100	125	150	200	250	300	350	400	500	600	800	900	~	~	~
	575V	[HP]	100	125	150	200	250	300	350	400	500	600	700	1000	1150	~	~	~
with 3 poles in series	260V DC	[A]	160	200	~	~	~	~	~	~	~	~	~	~	~	~	~	
	300V DC	[A]	~	~	230	250	~	~	~	~	~	~	~	~	~	~	~	
	340V DC	[A]	~	~	~	~	350	400	520	~	~	~	~	~	~	~	~	
	600V DC	[A]	~	~	~	~	~	~	~	500	650	750	900	1050	1350	1210	1900	

#### Electrical Data, Main Circuits

Coil Type:	Electronic	CA9-116	CA9-146	CA9-190	CA9-205	CA9-265	CA9-305	CA9-370	CA9-400	CA9-460	CA9-580	CA9-750	CA9-860	CA9-1060	CA9-1260	CA9-2050	CA9-2650
<b>Switching of 3-phase Motors, (50Hz)</b>																	
Ambient temperature	230V	[A]	84	103	128	156	195	230	280	307	377	~	~	~	~	~	~
60°C, AC-4	240V	[A]	84	103	125	156	195	230	280	307	377	~	~	~	~	~	~
	400V	[A]	84	103	128	156	195	230	280	307	377	~	~	~	~	~	~
	415V	[A]	84	103	128	156	195	230	280	307	377	~	~	~	~	~	~
	500V	[A]	84	103	128	156	195	230	280	307	377	~	~	~	~	~	~
	690V	[A]	66	80	93	104	153	162	188	313	350	~	~	~	~	~	~
	1000V	[A]	40	48	72	85	90	100	141	155	~	~	~	~	~	~	~
	230V	[kW]	25	32	40	50	55	75	90	90	110	~	~	~	~	~	~
	240V	[kW]	25	32	40	50	63	75	90	100	125	~	~	~	~	~	~
	400V	[kW]	45	55	63	80	110	132	160	160	200	~	~	~	~	~	~
	415V	[kW]	45	55	63	90	110	132	160	160	220	~	~	~	~	~	~
	500V	[kW]	55	63	90	110	132	160	200	220	250	~	~	~	~	~	~
	690V	[kW]	63	75	90	100	150	160	185	315	335	~	~	~	~	~	~
	1000V	[kW]	55	63	100	110	125	132	130	200	220	~	~	~	~	~	~
<b>AC-4 at approximately 200,000 operations</b>																	
	230V	[A]	38	38	49	55	73	89	100	118	135	~	~	~	~	~	~
	240V	[A]	38	38	49	55	73	89	100	118	135	~	~	~	~	~	~
	400/415V	[A]	38	38	49	55	73	89	100	118	135	~	~	~	~	~	~
	500V	[A]	33	33	37	44	53	59	68	78	89	~	~	~	~	~	~
	690V	[A]	33	33	37	44	53	59	68	78	89	~	~	~	~	~	~
	1000V	[A]	~	~	~	~	~	~	~	~	~	~	~	~	~	~	~
	230V	[kW]	11	11	13	15	22	25	30	37	40	~	~	~	~	~	~
	240V	[kW]	11	11	15	15	22	25	32	37	45	~	~	~	~	~	~
	400V	[kW]	20	20	25	30	40	50	55	63	75	~	~	~	~	~	~
	415V	[kW]	20	20	25	30	40	50	55	63	75	~	~	~	~	~	~
	500V	[kW]	22	22	25	30	37	40	45	55	63	~	~	~	~	~	~
	690V	[kW]	30	30	32	40	50	55	63	75	80	~	~	~	~	~	~
	1000V	[kW]	~	~	~	~	~	~	~	~	~	~	~	~	~	~	~
Max. switching frequency	[ops/hr]	150	150	150	150	150	150	150	150	60	60	~	~	~	~	~	~
<b>Wye-Delta (60Hz)</b>																	
	200V	[HP]	50	60	75	100	125	150	200	200	250	~	~	~	~	~	~
	230V	[HP]	60	75	100	125	150	200	250	250	350	450	500	~	~	~	~
	460V	[HP]	125	150	200	250	350	450	500	500	600	800	~	~	~	~	~
	575V	[HP]	150	200	250	300	450	500	600	600	700	1000	~	~	~	~	~

**Electrical Data, Main Circuits**

Coil Type:	Electronic	CA9-116	CA9-146	CA9-190	CA9-205	CA9-265	CA9-305	CA9-370	CA9-400	CA9-460	CA9-580	CA9-750	CA9-860	CA9-1060	CA9-1260	CA9-2050	CA9-2650
<b>cULus Elevator Duty</b>																	
	200V [A]	54	54	77	99	125	149	156	~	~	~	~	~	~	~	~	~
	230V [A]	54	54	77	99	125	149	156	~	~	~	~	~	~	~	~	~
	460V [A]	54	54	77	99	125	149	156	~	~	~	~	~	~	~	~	~
	575V [A]	54	54	77	99	125	149	156	~	~	~	~	~	~	~	~	~
	200V [HP]	15	15	20	30	40	40	50	~	~	~	~	~	~	~	~	~
	230V [HP]	20	20	25	30	40	50	60	~	~	~	~	~	~	~	~	~
	460V [HP]	40	40	60	75	100	100	125	~	~	~	~	~	~	~	~	~
	575V [HP]	50	50	75	100	125	150	150	~	~	~	~	~	~	~	~	~
<b>cULus HVAC Applications</b>																	
Definite purpose rating (3-Phase)																	
	FLA [A]	116	160	200	250	300	350	520	~	~	~	~	~	~	~	~	~
	230V [A]	700	960	1200	1500	1800	2100	3120	~	~	~	~	~	~	~	~	~
	LRA 460V [A]	580	800	1000	1250	1500	1750	2600	~	~	~	~	~	~	~	~	~
	575V [A]	470	640	800	1000	1200	1400	2080	~	~	~	~	~	~	~	~	~
	AC resistance heating 600V [A]	160	200	250	300	400	450	520	~	~	~	~	~	~	~	~	~
<b>Star-Delta Starting (50Hz)</b>																	
	≥230V [A]	200	252	329	355	458	528	640	692	796	1004	1299	1489	1835	~	~	~
	≥240V [A]	200	252	329	355	458	528	640	692	796	1004	1299	1489	1835	~	~	~
	400V [A]	200	252	329	355	458	528	640	692	796	1004	1299	1489	1835	~	~	~
	415V [A]	200	252	329	355	458	528	640	692	796	1004	1299	1489	1835	~	~	~
	500V [A]	190	225	233	285	433	502	545	692	796	1004	1299	1385	1680	~	~	~
	690V [A]	112	161	233	285	433	502	545	692	796	1004	1299	1385	1680	~	~	~
	1000V [A]	~	103	147	173	173	173	173	268	346	433	519	~	~	~	~	~
	230V [kW]	55	75	90	110	132	160	200	200	250	315	400	500	560	~	~	~
	240V [kW]	55	75	110	110	132	160	200	200	250	315	400	500	630	~	~	~
	400V [kW]	110	132	160	200	250	250	355	400	400	560	710	800	1000	~	~	~
	415V [kW]	110	132	160	200	250	315	355	400	400	560	800	900	1100	~	~	~
	500V [kW]	132	160	160	200	315	355	355	500	500	713	800	1000	1300	~	~	~
	690V [kW]	90	132	200	250	400	500	500	560	710	800	1100	1400	1700	~	~	~
	1000V [kW]	~	132	200	250	250	250	250	355	500	630	710	~	~	~	~	~

① Power rating at 50Hz. Preferred values according to IEC 60947-4-1.



**Electrical Data, Main Circuits**

Coil Type:	Electronic	CA9-116	CA9-146	CA9-190	CA9-205	CA9-265	CA9-305	CA9-370	CA9-400	CA9-460	CA9-580	CA9-750	CA9-860	CA9-1060	CA9-1260	CA9-2050	CA9-2650
------------	------------	---------	---------	---------	---------	---------	---------	---------	---------	---------	---------	---------	---------	----------	----------	----------	----------

**Switching of Power Transformers, AC-6a (50Hz)**

		Inrush Current Rated transformer current = n															
n = 30	≥230V [A]	70	79	111	115	143	165	200	252	263	286	430	254	362	~	~	~
	≥240V [A]	70	79	111	115	143	165	200	252	263	286	430	254	362	~	~	~
	≥400V [A]	70	79	111	115	143	165	200	252	263	286	430	254	362	~	~	~
	≥415V [A]	70	79	111	115	143	165	200	252	263	286	430	254	362	~	~	~
	≥500V [A]	70	79	111	115	143	165	200	252	263	286	~	~	362	~	~	~
	≥690V [A]	70	79	111	115	143	165	200	252	263	286	~	~	362	~	~	~
	≥1000V [A]	~	~	~	~	~	~	~	~	~	~	~	~	~	~	~	~
Apparent Power	230V [kW]	28	31	44	46	57	66	80	100	105	114	171	209	144	~	~	~
	240V [kW]	29	33	46	48	59	69	83	105	109	119	179	218	150	~	~	~
	400V [kW]	48	55	77	80	99	114	139	175	182	198	298	363	251	~	~	~
	415V [kW]	50	56	79	82	102	117	142	179	187	203	305	372	257	~	~	~
	500V [kW]	61	68	96	100	124	143	173	218	228	248	~	~	314	~	~	~
	690V [kW]	84	94	133	137	171	197	239	301	314	342	~	~	433	~	~	~
	1000V [kW]	~	~	~	~	~	~	~	~	~	~	~	~	~	~	~	~
n = 20	≥690V [A]	105	119	167	173	215	248	300	378	395	429	~	~	543	~	~	~
n = 15	≥690V [A]	140	158	222	230	286	330	400	504	526	572	~	~	724	~	~	~

**60 Hz Peak Inrush/peak rated transformer current**

n = 30	≥660V [A]	70	79	111	115	143	165	200	252	263	286	430	524	362	~	~	~
	200V [kVA]	24	27	38	40	50	57	69	87	91	99	149	182	125	~	~	~
	208V [kVA]	25	28	40	41	52	59	72	91	95	103	155	189	130	~	~	~
	240V [kVA]	29	33	46	48	59	69	83	105	109	119	179	218	150	~	~	~
	480V [kVA]	58	66	92	96	119	137	166	210	219	238	357	436	301	~	~	~
	600V [kVA]	73	82	115	120	149	171	208	262	273	297	447	545	376	~	~	~
	660V [kVA]	80	90	127	131	163	189	229	288	301	327	492	599	414	~	~	~
n = 20	≥660V [A]	105	119	167	173	215	248	300	378	395	429	645	786	543	~	~	~
Apparent Power	200V [kVA]	36	41	58	60	74	86	104	131	137	149	223	272	188	~	~	~
	208V [kVA]	38	43	60	62	77	89	108	136	142	155	232	283	196	~	~	~
	240V [kVA]	44	49	69	72	89	103	125	157	164	178	268	327	226	~	~	~
	480V [kVA]	87	99	139	144	179	206	249	314	328	357	536	653	451	~	~	~
	600V [kVA]	109	124	174	180	223	258	312	393	410	446	670	817	564	~	~	~
	660V [kVA]	120	136	191	198	246	284	343	432	452	490	737	899	621	~	~	~
n = 15	≥660V [A]	140	158	222	230	286	330	400	504	526	572	860	1048	724	~	~	~
Apparent Power	200V [kVA]	48	55	77	80	99	114	139	175	182	198	298	363	251	~	~	~
	208V [kVA]	50	57	80	83	103	119	144	182	190	206	310	378	261	~	~	~
	240V [kVA]	58	66	92	96	119	137	166	210	219	238	357	436	301	~	~	~
	480V [kVA]	116	131	185	191	238	274	333	419	437	476	715	871	602	~	~	~
	600V [kVA]	145	164	231	239	297	343	416	524	547	594	894	1089	752	~	~	~
	660V [kVA]	160	181	254	263	327	377	457	576	601	654	983	1198	828	~	~	~

**Electrical Data, Main Circuits**

Coil Type:	Electronic	CA9-116	CA9-146	CA9-190	CA9-205	CA9-265	CA9-305	CA9-370	CA9-400	CA9-460	CA9-580	CA9-750	CA9-860	CA9-1060	CA9-1260	CA9-2050	CA9-2650
<b>Switching of 3-Phase Capacitors, AC-6b (50Hz)</b>																	
Single capacitor 40°C	230V [kVar]	40	50	60	75	85	100	110	120	140	170	220	250	300	~	~	~
	240V [kVar]	40	50	60	75	85	100	110	120	140	170	220	250	300	~	~	~
	400V [kVar]	75	90	110	130	145	165	200	210	240	285	400	450	500	~	~	~
	415V [kVar]	75	90	110	130	145	165	200	210	240	285	400	450	500	~	~	~
	500V [kVar]	83	110	140	160	180	210	240	260	325	350	490	550	600	~	~	~
	690V [kVar]	80	110	135	170	200	240	280	300	325	440	600	650	800	~	~	~
	1000V [kVar]	~	100	140	150	155	160	170	250	300	350	450	~	~	~	~	~
Single capacitor 55°C	230V [kVar]	40	50	60	75	85	100	110	120	140	170	220	250	300	~	~	~
	240V [kVar]	40	50	60	75	85	100	110	120	140	170	220	250	300	~	~	~
	400V [kVar]	75	90	110	130	145	165	200	210	240	285	400	450	500	~	~	~
	415V [kVar]	75	90	110	130	145	165	200	210	240	285	400	450	500	~	~	~
	500V [kVar]	83	110	140	160	180	210	240	260	325	350	490	550	600	~	~	~
	690V [kVar]	80	110	135	170	200	240	280	300	325	440	600	650	800	~	~	~
	1000V [kVar]	~	100	140	150	155	160	170	250	300	350	450	~	~	~	~	~
Single capacitor 70°C	230V [kVar]	35	42	45	57	70	85	100	105	120	160	190	230	280	~	~	~
	240V [kVar]	35	42	45	57	70	85	100	105	120	160	190	230	280	~	~	~
	400V [kVar]	65	74	83	105	135	155	180	195	225	275	370	430	480	~	~	~
	415V [kVar]	65	74	83	105	135	155	180	195	225	275	370	430	480	~	~	~
	500V [kVar]	78	96	102	130	165	196	220	241	300	340	435	530	570	~	~	~
	690V [kVar]	75	110	135	160	200	240	260	300	325	440	600	630	750	~	~	~
	1000V [kVar]	~	95	120	130	140	150	160	220	270	300	400	~	~	~	~	~
60Hz Single Capacitor - 40°C	200V [kVar]	33	41	50	67	83	100	125	114	137	171	205	~	346	~	~	~
	230V [kVar]	38	48	57	77	95	115	144	131	157	196	236	~	398	~	~	~
	460V [kVar]	75	100	125	150	200	250	300	274	329	411	494	~	832	~	~	~
	600V [kVar]	100	125	150	200	250	300	350	343	410	514	618	~	1040	~	~	~
<b>Switching of Lamps</b>																	
Gas discharge lamps AC-5a (Open)	[A]	116	146	190	205	265	305	370	400	460	580	750	877	1072	812	1332	1722
UL Ballast Ratings	[A]	160	200	250	300	400	450	520	~	~	~	~	~	~	~	~	~
Filament AC-5b	230/240V [A]	116	146	190	205	265	305	370	400	460	580	750	877	1072	812	1332	1722

**Electrical Data, Main Circuits**

Coil Type:	Electronic	CA9-116	CA9-146	CA9-190	CA9-205	CA9-265	CA9-305	CA9-370	CA9-400	CA9-460	CA9-580	CA9-750	CA9-860	CA9-1060	CA9-1260	CA9-2050	CA9-2650
<b>Switching of DC Loads</b>																	
Non-inductive or slightly inductive loads or resistance furnaces DC-1 at 60°C																	
1-Pole	≤72V [A]	160	200	250	350	400	500	520	600	700	800	1050	1350	1650	1250	2050	~
	90V [A]	160	200	250	350	400	500	520	~	~	~	~	~	~	~	~	~
	100V [A]	~	~	250	350	400	500	520	~	~	~	~	~	~	~	~	~
	110V [A]	~	~	~	~	400	500	520	600	700	800	1050	1350	1650	1250	2050	~
2 Poles in series	≤72V [A]	160	200	250	350	400	500	520	600	700	800	1050	1350	1650	1250	2050	~
	110V [A]	160	200	250	350	400	500	520	600	700	800	1050	1350	1650	1250	2050	~
	175V [A]	160	200	250	350	400	500	520	600	700	800	1050	~	~	~	~	~
	200V [A]	~	~	250	350	400	500	520	600	700	800	1050	~	~	~	~	~
	220V [A]	~	~	~	~	400	500	520	600	700	800	1050	~	~	~	~	~
3-Poles in series	≤72V [A]	160	200	250	350	400	500	520	600	700	800	1050	1350	1650	1250	2050	~
	110V [A]	160	200	250	350	400	500	520	600	700	800	1050	1350	1650	1250	2050	~
	175V [A]	160	200	250	350	400	500	520	600	700	800	1050	1350	1650	1250	2050	~
	220V [A]	160	200	250	350	400	500	520	600	700	800	1050	1350	1650	1250	2050	~
	260V [A]	160	200	250	350	400	500	520	600	700	800	1050	1350	1650	1250	2050	~
	300V [A]	~	~	250	350	400	500	520	600	700	800	1050	1350	1650	1250	2050	~
	340V [A]	~	~	~	~	400	500	520	600	700	800	1050	1350	1650	1250	2050	~
	600V [A]	~	~	~	~	~	~	~	600	700	800	1050	1350	1650	1250	2050	~
850V [A]	~	~	~	~	~	~	~	~	~	800	1050	1350	1650	1250	2050	~	
<b>Shunt-wound motors</b>																	
Starting, reverse current breaking, reversing, stepping DC-3, 60°C																	
3-Poles in series	24V [A]	145	160	250	275	350	400	450	600	700	800	1050	~	~	~	~	~
	48/60V [A]	145	160	250	275	350	400	450	600	700	800	1050	~	~	~	~	~
	110V [A]	145	160	250	275	350	400	450	600	700	800	1050	~	~	~	~	~
	220V [A]	145	160	250	275	350	400	450	600	700	800	1050	~	~	~	~	~
	440V [A]	~	~	~	~	~	~	~	600	700	800	1050	~	~	~	~	~
<b>Series-wound motors</b>																	
Starting, reverse current breaking, reversing, stepping DC-5, 60°C																	
3-Poles in series	24V [A]	145	160	250	275	350	400	450	600	700	800	1050	~	~	~	~	~
	48/60V [A]	145	160	250	275	350	400	450	600	700	800	1050	~	~	~	~	~
	110V [A]	145	160	250	275	350	400	450	600	700	800	1050	~	~	~	~	~
	220V [A]	145	160	250	275	350	400	450	600	700	800	1050	~	~	~	~	~
	440V [A]	~	~	~	~	~	~	~	600	700	800	1050	~	~	~	~	~
<b>Short Time Withstand /<sub>cw</sub> 60° C</b>																	
1 s [A]	1300	1460	1900	2050	2650	3050	3700	4600	4600	7000	7000	10000	12000	8000	12000	12000	
10 s [A]	928	1168	1520	1640	2120	2446	2960	4400	4400	6400	6400	8000	10000	7200	10000	10000	
30 s [A]	536	674	878	947	1224	1409	1709	3100	3100	4500	4500	6000	7500	5200	7500	7500	
1 min [A]	379	477	621	670	865	996	1208	2500	2500	3500	3500	4500	5500	4000	5500	5500	
15 min [A]	160	225	275	350	400	500	600	840	840	1300	1300	1600	2200	1500	2200	2800	
<b>Resistance and Power Dissipation</b>																	
Main current circuit resistance [mΩ]	0.469	0.454	0.198	0.204	0.200	0.200	0.200	0.200	0.083	0.086	0.050	0.045	0.044	0.029	0.050	0.030	0.028
Power dissipation per pole at I <sub>e</sub> AC-1, 400V [W]	12	23	15	25	32	50	72	30	42	32	50	80	80	80	125	200	
Power dissipation per pole at I <sub>e</sub> AC-3, 400V [W]	6	10	7	8	14	19	27	16	21	17	28	50	50	~	~	~	
Total power dissipation at:																	
I <sub>e</sub> AC3, 400V; AC/DC control 120-250V [W]	21	33	23.5	26.5	46.5	61.5	85.5	53	68	56	89	171	171	~	~	~	
<b>Maximum Switching Frequency</b>																	
AC-1 ops/hr	300	300	300	300	300	300	300	300	300	300	300	300	60	60	300	60	15
AC-3 ops/hr	300	300	300	300	300	300	300	300	300	300	300	300	60	60	~	~	~
AC-2, AC-4 ops/hr	150	150	150	150	150	150	150	60	60	60	60	60	60	60	~	~	~
<b>Weight</b>																	
AC/DC (Electronic) kg	1.5	1.5	3	3	4.64	4.64	4.64	12	12	15	15	34	35	16	35	45	
with bar connections (lbs)	(3.3)	(3.3)	(6.6)	(6.6)	(10.2)	(10.2)	(10.2)	(26.4)	(26.4)	(33)	(33)	(74.8)	(77)	(35.2)	(77)	(99)	
with built-in cable clamps kg	1.75	1.75	~	~	~	~	~	~	~	~	~	~	~	~	~	~	
(lbs)	(3.85)	(3.85)	~	~	~	~	~	~	~	~	~	~	~	~	~	~	

**Short Circuit Ratings**

		CA9-116	CA9-146	CA9-190	CA9-205	CA9-265	CA9-305	CA9-370	CA9-400	CA9-460	CA9-580	CA9-750	CA9-860	CA9-1060	CA9-1260	CA9-2050	CA9-2650	
<b>Short Circuit Coordination (Max. Fuse or Circuit Breaker Rating)</b>																		
per IEC 60947-4-1																		
<b>DIN Fuses -gG</b> 100 kA Available Fault Current																		
Type "2" (400V)	[A]	250	250	315	315	400	500	630	630	630	800	800	1000	1250	~	~	~	
<b>DIN Fuses -gG</b> 80 kA Available Fault Current																		
Type "2" (690V)	[A]	160	200	315	315	400	425	500	500	630	800	800	1000	1600	~	~	~	
<b>MCCB</b> 70 kA Available Fault Current																		
Type "2" (400V)	[A]	160	160	320	320	400	630	630	630	630	800	1000	1600	1600	~	~	~	
<b>Short Circuit Coordination (Max. Fuse or Circuit Breaker Rating)</b>																		
per UL 60947 and CSA 22.2 No. 14 (contactor and fuses or circuit breaker only)																		
<b>UL Class RK5 Fuses</b> 10 kA Available Fault Current																		
Type 1 Combination (600V)	[A]	250	250	400	400	~	~	~	~	~	~	~	~	~	~	~	~	~
<b>UL Class L Fuses</b> 18 kA Available Fault Current																		
Type 1 Combination (600V)	[A]	~	~	~	~	800	800	800	1000	~	~	~	~	~	~	~	~	~
<b>UL Class L Fuses</b> 30 kA Available Fault Current																		
Type 1 Combination (600V)	[A]	~	~	~	~	~	~	~	~	1000	~	~	~	~	~	~	~	~
<b>UL Class L Fuses</b> 85 kA Available Fault Current																		
Type 1 Combination (600V)	[A]	~	~	~	~	~	~	~	~	~	~	~	1600	1600	~	~	~	~
<b>UL Class J and CSA HRCI-J Fuses</b> 100 kA Available Fault Current																		
Type 1 Combination (600V)	[A]	250	250	400	400	600	600	800	600	600	~	~	~	~	~	~	~	~
Type 2 Combination (600V)	[A]	200	200	400	400	600	600	600	600	600	~	~	~	~	~	~	~	~
<b>UL Class L Fuses</b> 100 kA Available Fault Current																		
Type 1 Combination (600V)	[A]	~	~	~	~	~	~	~	800	800	1200	1200	~	~	1600	~	~	~
Type 2 Combination (600V)	[A]	~	~	~	~	~	~	~	~	~	1200	1200	~	~	~	~	~	~
<b>UL Inverse-Time Circuit</b> 42 kA Available Fault Current																		
Type 1 Combination (480V)	[A]	~	~	~	~	~	~	~	~	~	1200	1200	2000	2000	~	~	~	~
<b>UL Inverse-Time Circuit</b> 65 kA Available Fault Current																		
Type 1 Combination (480V)	[A]	250	250	400	400	800	800	800	800	800	800	800	~	~	~	~	~	~
<b>UL Inverse-Time Circuit</b> 84 kA Available Fault Current																		
Type 1 Combination (480V)	[A]	~	~	~	~	~	~	~	800	800	~	~	~	~	~	~	~	~
<b>UL Inverse-Time Circuit</b> 89 kA Available Fault Current																		
Type 1 Combination (480V)	[A]	~	~	~	~	~	~	~	~	~	800	800	~	~	~	~	~	~
<b>UL Inverse-Time Circuit</b> 100 kA Available Fault Current																		
Type 1 Combination (480V)	[A]	250	250	400	400	800	800	800	~	~	~	~	~	~	~	~	~	~
<b>UL Inverse-Time Circuit</b> 25 kA Available Fault Current																		
Type 2 Combination (600V)	[A]	250	250	~	~	~	~	~	~	~	~	~	~	~	~	~	~	~
<b>UL Inverse-Time Circuit</b> 35 kA Available Fault Current																		
Type 2 Combination (600V)	[A]	~	~	400	400	800	800	800	600	800	800	800	~	~	~	~	~	~
<b>UL Inverse-Time Circuit</b> 42 kA Available Fault Current																		
Type 1 Combination (600V)	[A]	~	~	~	~	800	800	800	600	800	800	800	~	~	~	~	~	~
<b>UL Inverse-Time Circuit</b> 50 kA Available Fault Current																		
Type 1 Combination (600V)	[A]	250	250	~	~	~	~	~	~	~	~	~	~	~	~	~	~	~
<b>UL Inverse-Time Circuit</b> 65 kA Available Fault Current																		
Type 1 Combination (600V)	[A]	~	~	400	400	400	400	400	~	~	~	~	~	~	~	~	~	~

**Coil Data**

Coil type: Electronic			CA9- 116...146	CA9- 190...205	CA9- 265...370	CA9- 400...460	CA9- 580...750	CA9- 860...1060	CA9- 1260	CA9- 2050...2650
<b>Operating Limits</b>										
50/60 Hz	pick-up	[xUs]	0.85...1.1							
	dropout	[xUs]	0.55							
DC control	pick-up	[xUs]	0.80...1.1							
	dropout	[xUs]	0.55							
24...60V AC	pick-up	[VA]	225	165	475	~	~	~	~	~
	hold-in	[VA]	5.5	6	8.5	~	~	~	~	~
48...130V AC	pick-up	[VA]	170	175	340	1215	1100	~	1100	~
	hold-in	[VA]	4	4	17	12	12	~	12	~
100...250V AC	pick-up	[VA]	130	220	385	955	880	2450	880	2450
	hold-in	[VA]	6	7	17.5	12	12	48	12	48
250...500V AC	pick-up	[VA]	205	185	420	950	985	~	985	~
	hold-in	[VA]	16	16	21	12	12	~	12	~
24...60V DC	pick-up	[W]	210	205	400	900	785	~	785	~
	hold-in	[W]	2.5	2.5	3.5	5	5.5	~	5.5	~
48...130V DC	pick-up	[W]	130	130	360	1150	1020	~	120	~
	hold-in	[W]	2.5	2.5	2.5	5	5	~	5	~
100...250V DC	pick-up	[W]	135	190	410	895	880	2290	880	2290
	hold-in	[W]	3	2.5	4.5	5	5	20.5	5	20.5
250...500V DC	pick-up	[W]	205	190	600	885	910	~	910	~
	hold-in	[W]	4	4	4.7	7.5	7.5	~	7.5	~
<b>Operating Times</b>										
AC or DC	closing delay	[ms]	20...55	25...60	30...60	50...120	50...120	50...80	50...120	50...80
	opening delay	[ms]	40...70	45...80	45...80	33...70	33...70	35...55	33...70	35...55
With PLC Interface	closing delay	[ms]	20...31	25...45	25...45	40...60	40...90	40...65	40...90	40...65
	opening delay	[ms]	24...34	25...45	25...45	10...30	10...30	10...30	10...30	10...30

**Mechanical Data**

		CA9-116	CA9-146	CA9-190	CA9-205	CA9-265	CA9-305	CA9-370	CA9-400	CA9-460	CA9-580	CA9-750	CA9-860	CA9-1060	CA9-1260	CA9-2050	CA9-2650	
<b>Main Terminals</b>																		
Conductor Cross Sections - Main Contacts Terminal Type																		
	(1) conductor Clamp Type	[mm <sup>2</sup> ] 10...95 CA9-CL146	[mm <sup>2</sup> ] 6...150 CA9-TL205	[mm <sup>2</sup> ] 16...300 CA9-TL370	~	~	~	~	~	~	~	~	~	~	~	~	~	
Recommended torque		[Nm]	8	34	42	~	~	~	~	~	~	~	~	~	~	~	~	
	(2) conductors Clamp Type	[mm <sup>2</sup> ] 10...95 CA9-CL146	~	~	~	16...500 CA9-TL370B	~	~	70...500 CA9-TL580	70...500 CA9-TL750	70...500 CA9-TL750	120...500 CA9-TL860	70...750 CA9-TL1060	~	~	~	~	
Recommended torque		[Nm]	8	~	~	42	~	~	31	43	43	43	57	~	~	~	~	
	(3) conductors Clamp Type	[mm <sup>2</sup> ] ~	~	~	~	~	~	~	~	70...500 CA9-TL750	70...500 CA9-TL750	120...500 CA9-TL860	70...750 CA9-TL1060	70...500 CA9-TL750	~	~	~	
Recommended torque		[Nm]	~	~	~	~	~	~	~	43	43	43	57	43	~	~	~	
	(4) conductors Clamp Type	[mm <sup>2</sup> ] ~	~	~	~	~	~	~	~	~	~	120...500 CA9-TL860	70...750 CA9-TL1060	~	~	~	~	
Recommended torque		[Nm]	~	~	~	~	~	~	~	~	~	43	57	~	~	~	~	
	(6) conductors Clamp Type	[mm <sup>2</sup> ] ~	~	~	~	~	~	~	~	~	~	~	70...750 CA9-TL1060B	~	~	~	~	
Recommended torque		[Nm]	~	~	~	~	~	~	~	~	~	~	57	~	~	~	~	
	L max.	[mm]	22	24	32	47	50	100	50	100	50	100	50	100	50	100	100	
	ø min.	[mm]	6	8	10	10	10	12	12	12	12	12	12	12	12	12	12	
Recommended torque		[Nm]	9	18	28	35	45	45	45	45	45	45	45	45	45	45	45	



**Cross Section per cULus**

	(1) conductor Clamp Type	[AWG] 6...3/0 CA9-CL146	[MCM] 6...300 CA9-TL205	[MCM] 4...400 CA9-TL370	~	~	~	~	~	~	~	~	~	~	~	~	~
Recommended torque		[lb-in]	80	300	375	~	~	~	~	~	~	~	~	~	~	~	~
	(2) conductors Clamp Type	[AWG] 6...3/0 CA9-CL146	~	~	~	4...500 CA9-TL370B	2/0...500 CA9-TL580	2/0...500 CA9-TL750	2/0...500 CA9-TL750	4/0...500 CA9-TL860	4/0...500 CA9-TL860	1/0...750 CA9-TL1060	1/0...750 CA9-TL1060	2/0...500 CA9-TL750	~	~	~
Recommended torque		[lb-in]	80	~	~	375	275	375	375	375	375	500	375	375	~	~	~
	(3) conductors Clamp Type	[AWG] ~	~	~	~	~	~	~	~	2/0...500 CA9-TL750	4/0...500 CA9-TL860	1/0...750 CA9-TL1060	1/0...750 CA9-TL1060	2/0...500 CA9-TL750	~	~	~
Recommended torque		[lb-in]	~	~	~	~	~	~	~	375	375	500	375	375	~	~	~
	(4) conductors Clamp Type	[AWG] ~	~	~	~	~	~	~	~	~	~	4/0...500 CA9-TL860	1/0...750 CA9-TL1060	~	~	~	~
Recommended torque		[lb-in]	~	~	~	~	~	~	~	~	~	375	500	~	~	~	~
	(6) conductors Clamp Type	[AWG] ~	~	~	~	~	~	~	~	~	~	~	1/0...750 CA9-TL1060B	~	~	~	~
Recommended torque		[lb-in]	~	~	~	~	~	~	~	~	~	~	500	~	~	~	~
	L max.	[in]	0.866	0.945	1.26	1.85	1.97	3.94	1.97	3.94	3.94	3.94	1.97	3.94	1.97	3.94	3.94
	ø min.	[in]	0.236	0.315	0.394	0.394	0.394	0.472	0.394	0.472	0.472	0.472	0.472	0.472	0.472	0.472	0.472
Recommended torque		[lb-in]	80	160	248	310	398	398	398	398	398	398	398	398	398	398	398

**Conductor Cross Sections**

Coil Terminals Terminal Type																	
	(1) conductor	[mm <sup>2</sup> ]	0.75...2.5														
	(2) conductors	[mm <sup>2</sup> ]	0.75...2.5														
	(1) conductor	[mm <sup>2</sup> ]	1...4														
	(2) conductors	[mm <sup>2</sup> ]	1...4														
Recommended torque		[Nm]	1...1.2														
Cross section per cULus		[AWG]	18...14														
Recommended torque		[lb-in]	8.9...10.6														

## Electrical Data, Auxiliary Contacts

For Reversing and Non-Reversing			CA9-S1/2*	CA9-S3/4*	CA9-S*-B*	
<b>Switching of AC Loads</b>						
Rated Insulation voltage $U_i$			690V	690V	250V	
Rated Operational voltage $U_e$			690V	690V	125V	
Rated Impulse Withstand voltage $U_{imp}$			6kV	6kV	1.5kV	
AC-12 $I_{th}$	at 40°C	[A]	16	16	0.1	
	at 60°C	[A]	~	~	~	
AC-14 at rated voltage of	24V	[A]	~	~	0.1	
	42/48V	[A]	~	~	0.1	
	120V	[A]	~	~	0.1	
AC-15 at rated voltage of	24V	[A]	6	6	~	
	42/48V	[A]	6	6	~	
	120V	[A]	6	6	~	
	230V	[A]	4	4	~	
	240V	[A]	4	4	~	
	400V	[A]	3	3	~	
AC-15 at rated voltage of	415V	[A]	3	3	~	
	500V	[A]	2	2	~	
	690V	[A]	2	2	~	
	690V	[A]	2	2	~	
<b>Switching of DC Loads</b>						
DC-12 L/R < 1 ms resistive loads at	24V DC	[A]	~	~	0.1	
	48V DC	[A]	~	~	0.1	
	110V DC	[A]	~	~	0.1	
	220V DC	[A]	~	~	~	
	440V DC	[A]	~	~	~	
DC-12 L/R < 15 ms inductive loads with economy resistor in series at	24V DC	[A]	~	~	~	
	48V DC	[A]	~	~	~	
	110V DC	[A]	~	~	~	
	220V DC	[A]	~	~	~	
	440V DC	[A]	~	~	~	
DC-13 switching electromagnetics at	24V DC	[A]	3	6	~	
	48V DC	[A]	1.5	2.8	~	
	110V DC	[A]	0.55	0.55	~	
	220V DC	[A]	0.3	0.3	~	
	440V DC	[A]	~	~	~	
<b>Fuse gG</b>						
Short-circuit protection with no welding of contacts per IEC 60947-5-2		[A]	10	10	0.1	
		[A]	10	10	0.1	
<b>Protective Separation per IEC 60947-1, Annex N</b>						
Min. Switching capacity at 24V IEC 60947-5-4			[mA]	50	50	~
Min. Switching capacity at 3V IEC 60947-5-4			[kVA]	~	~	1
<b>Load Carrying Capacity per cULus</b>						
Rated voltage	AC	[V]	600	600	125	
Continuous rating	40°C	[A]	10	10	0.1	
Switching capacity	AC		A 600	A 600	~	
Rated voltage	DC	[V]	250	250	125	
Continuous rating	40°C	[A]	2.5	2.5	0.1	
Switching capacity	DC		P 600	Q 300	~	
	660V	[kVA]	160	181	254	

**Life-Load Curves**

3-Pole Contactors  
Electrical Durability

Electrical durability for AC-1 utilization category -  $U_e \leq 690V$  **①**  
Switching non-inductive or slightly inductive loads.  
The breaking current  $I_c$  for AC-1 is equal to the rated operational current of the load.

**A**  
CA9 Contactors

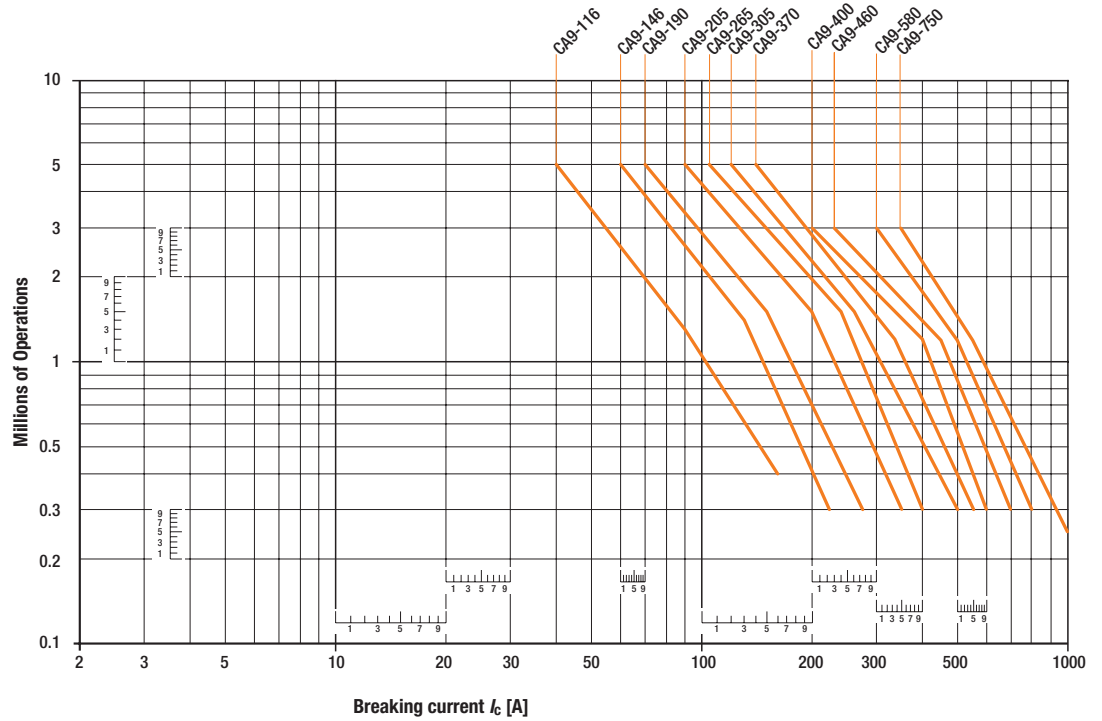

Instructions on  
**How to** read  
Life Curves  
can be found on page A8

① CA9-860 and CA9-1060 electrical durability at the rated current is 50,000 operating cycles.



**Life-Load Curves**

3-Pole Contactors  
Electrical Durability

**Electrical durability for AC-3 utilization category -  $U_e \leq 440V$  ❶**

Switching cage motors: starting and switching off running motors.

The breaking current  $I_c$  for AC-3 is equal to the rated operational current  $I_e$  ( $I_e$  = motor full load current).

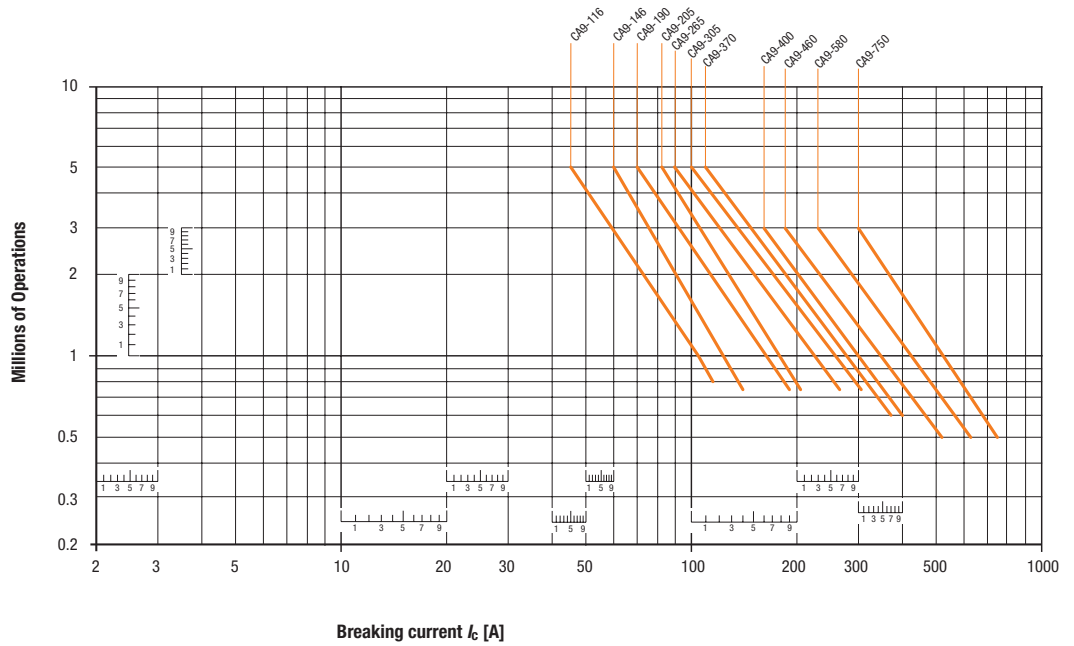

**Electrical durability for AC-3 utilization category -  $440V < U_e \leq 690V$  ❷**

Switching cage motors: starting and switching off running motors.

The breaking current  $I_c$  for AC-3 is equal to the rated operational current  $I_e$  ( $I_e$  = motor full load current).

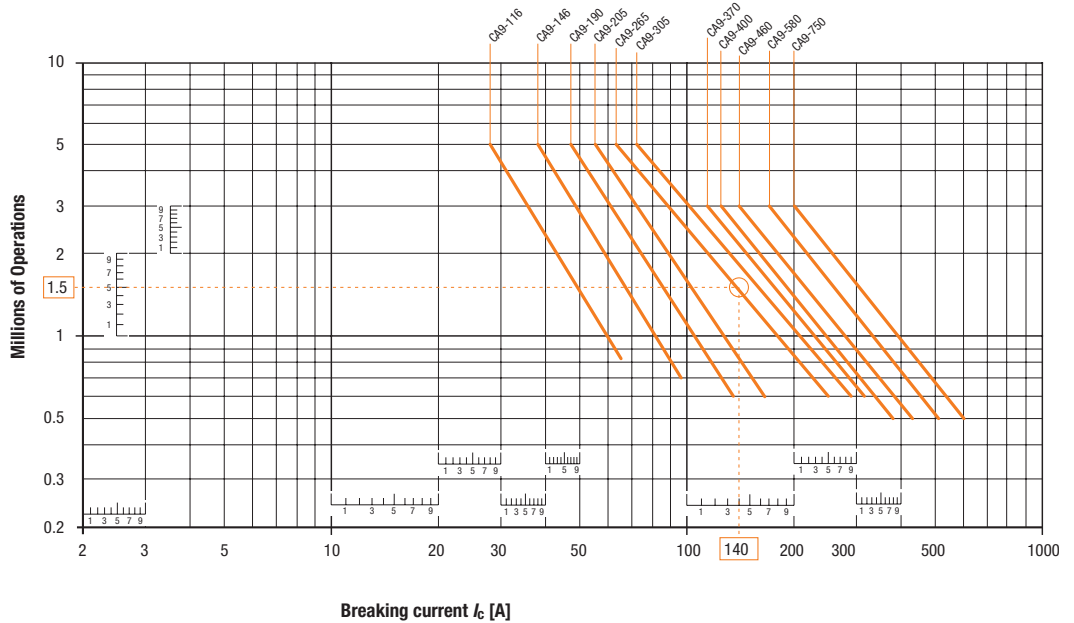

❶ CA9-860 and CA9-1060 electrical durability at the rated current is 50,000 operating cycles.

**Life-Load Curves**

3-Pole Contactors  
Electrical Durability

**Electrical durability for AC-2 or AC-4 utilization category -  $U_e \leq 440V$**

Switching cage motors: starting/reversing, and step-by-step operation.

The breaking current  $I_c$  is equal to  $2.5 \times I_e$  for AC-2 and  $6 \times I_e$  for AC-4, keeping in mind that  $I_e$  is the motor rated operational current ( $I_e =$  motor full load current).

**A**

CA9 Contactors

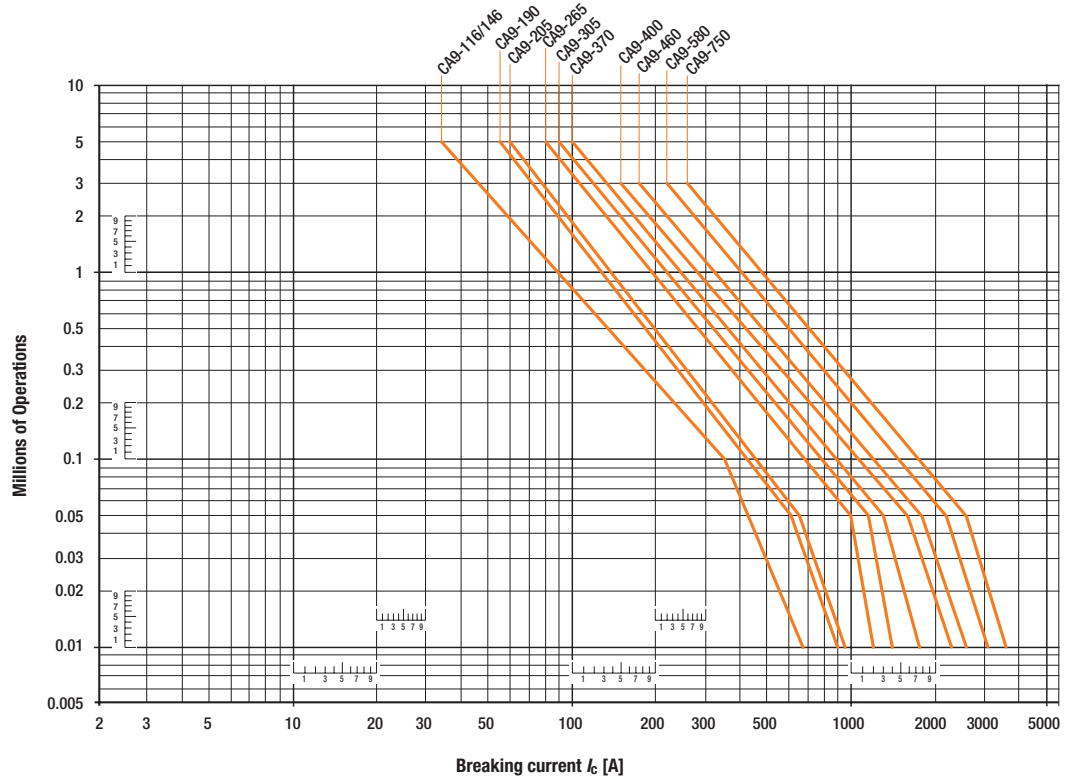

**Life-Load Curves**

3-Pole Contactors  
Electrical Durability

**Electrical durability for AC-2 or AC-4 utilization category -  $440V < U_e \leq 690V$**   
 Switching cage motors: starting/reversing, and step-by-step operation.  
 The breaking current  $I_c$  is equal to  $2.5 \times I_e$  for AC-2 and  $6 \times I_e$  for AC-4,  
 keeping in mind that  $I_e$  is the motor rated operational current ( $I_e =$  motor full load current).

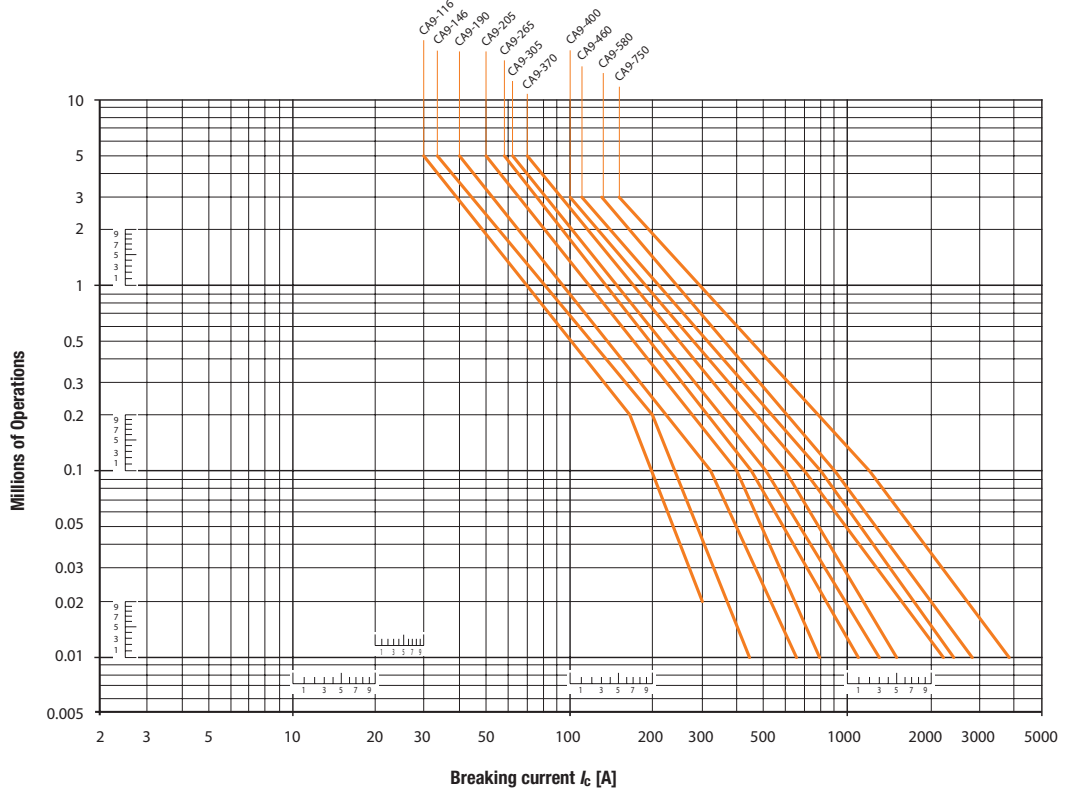

**Series CA9-116...146--L (Contactors/Reversing Contactors)**

Dimensions are in millimeters (inches). Dimensions not intended for manufacturing purposes.

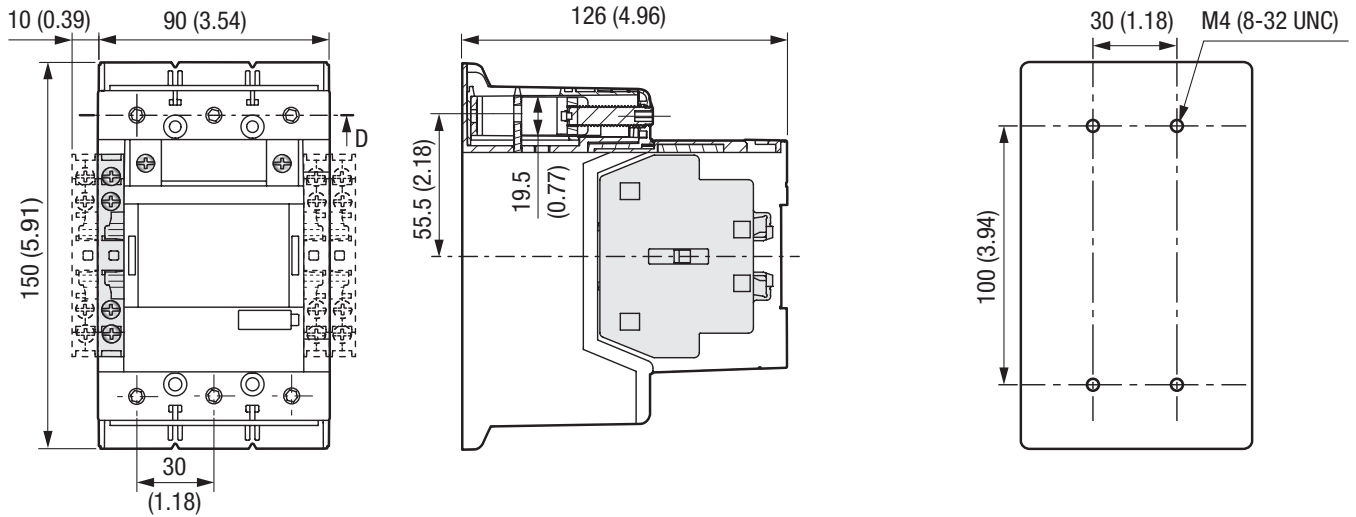

**Series CA9-116-El...146-El--L (Contactors/Reversing Contactors with PLC Interface)**

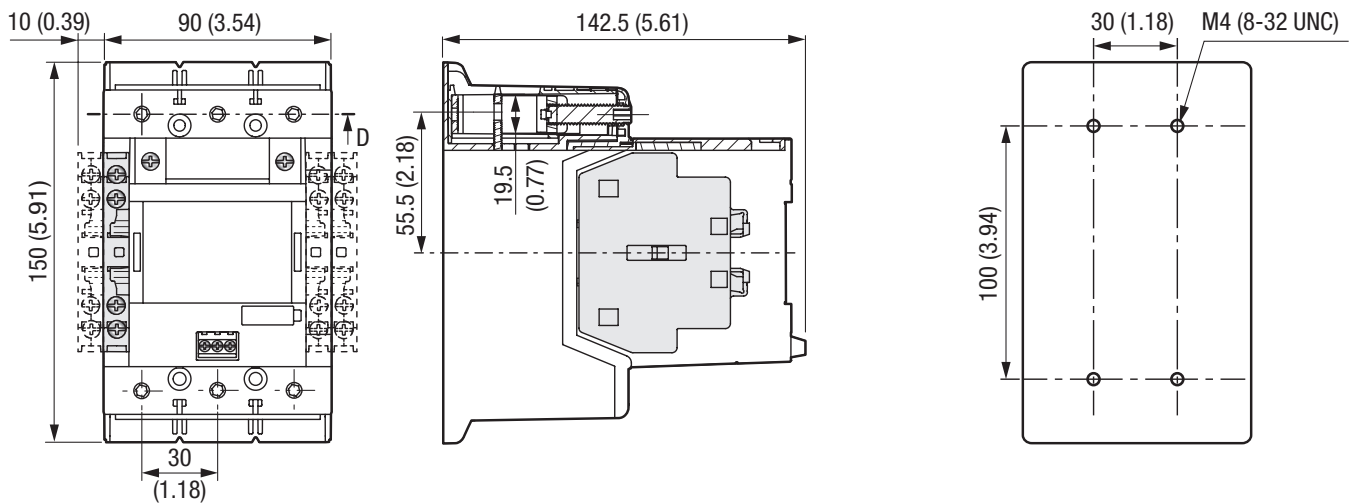

**Mounting Position**

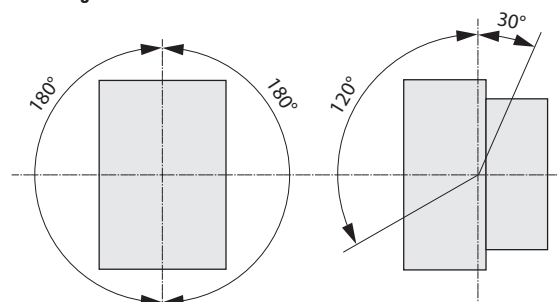

**Series CA9-190...205 (Contactors/Reversing Contactors)**

Dimensions are in millimeters (inches). Dimensions not intended for manufacturing purposes.

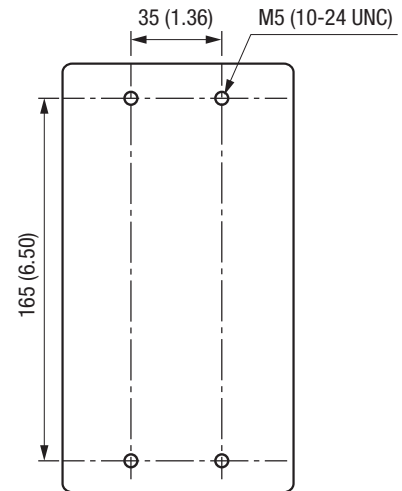
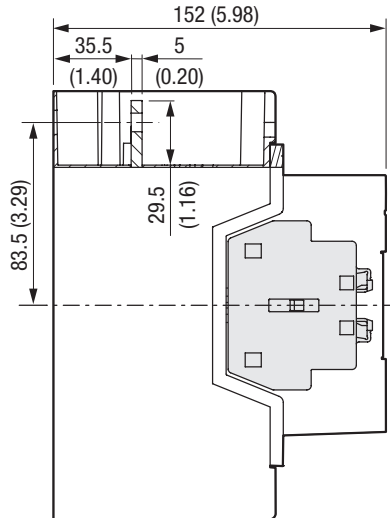
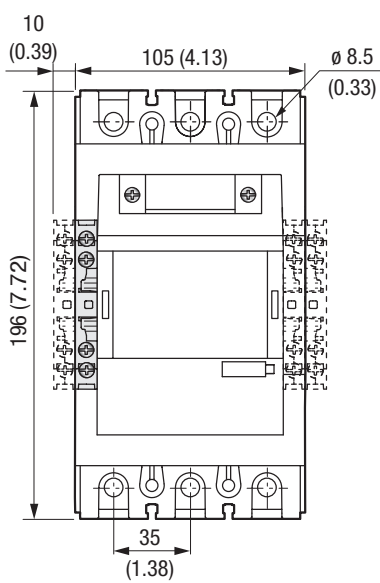

**Series CA9-190-EI...205-EI (Contactors/Reversing Contactors with PLC Interface)**

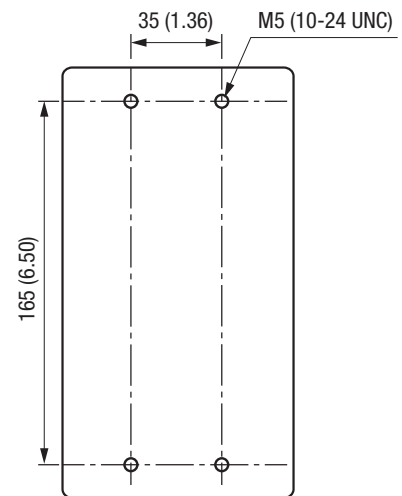
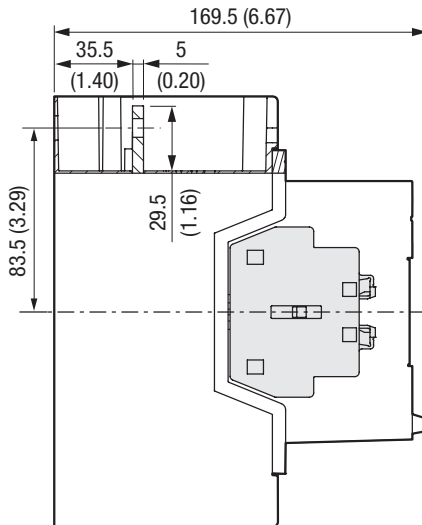
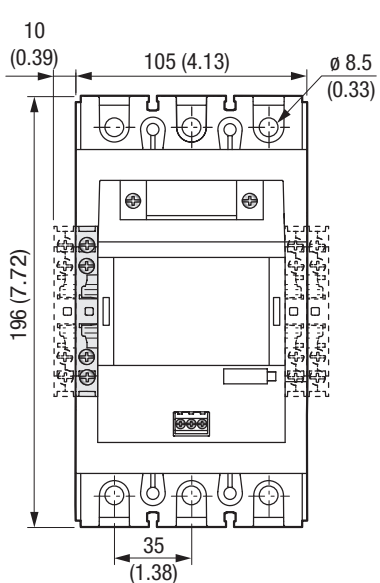

**Series CA9-265...370 (Contactors/Reversing Contactors)**

Dimensions are in millimeters (inches). Dimensions not intended for manufacturing purposes.

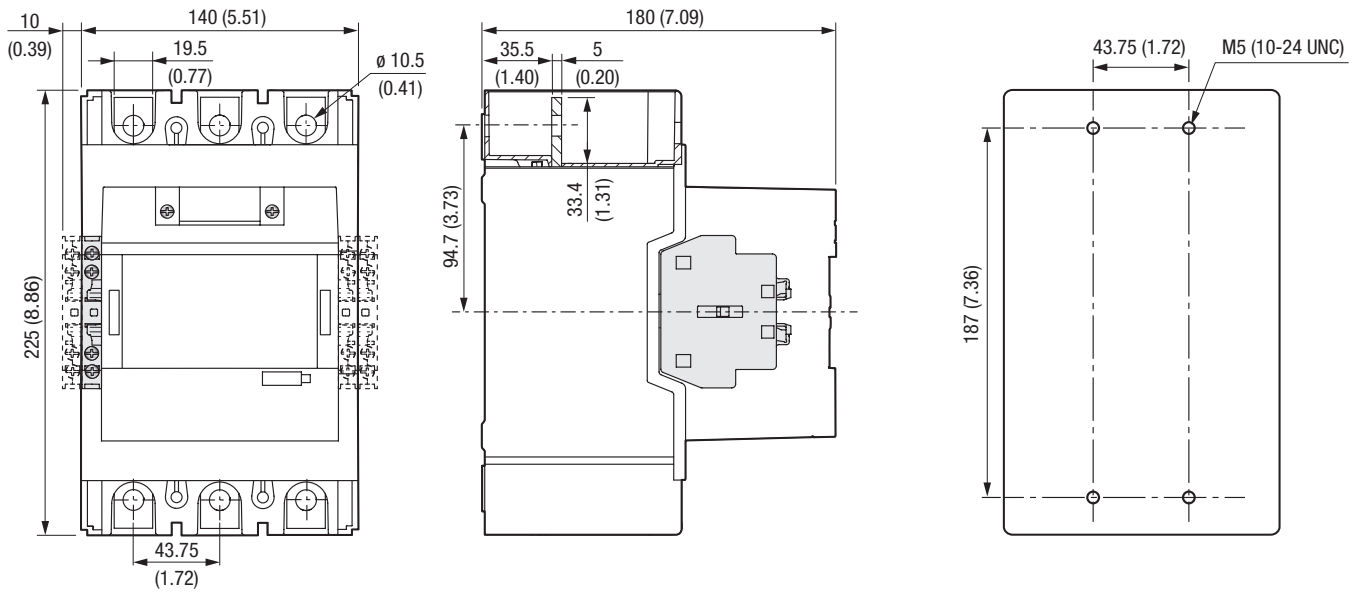

**Series CA9-265-EI...370-EI (Contactors/Reversing Contactors with PLC Interface)**

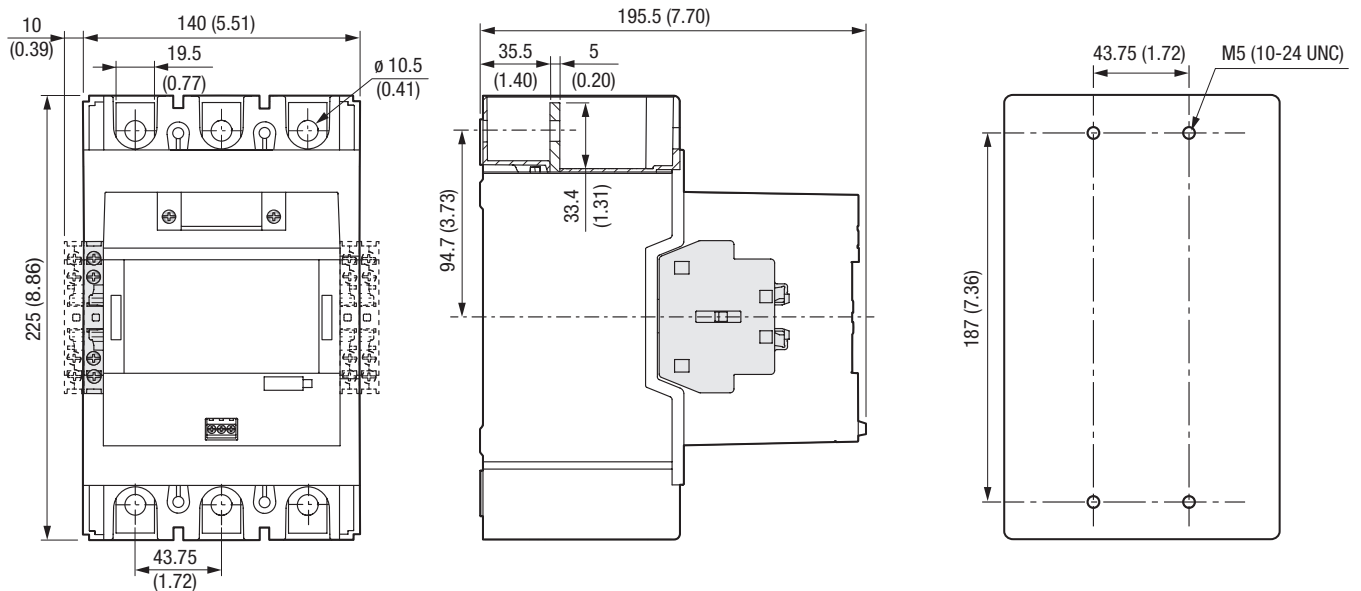

**Series CA9-400-EI...460-EI (Contactors/Reversing Contactors with PLC Interface)**

Dimensions are in millimeters (inches). Dimensions not intended for manufacturing purposes.

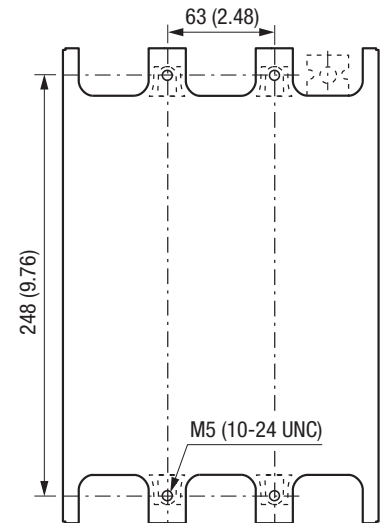
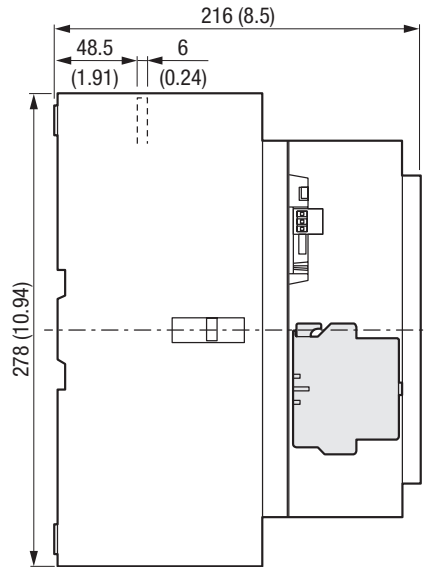
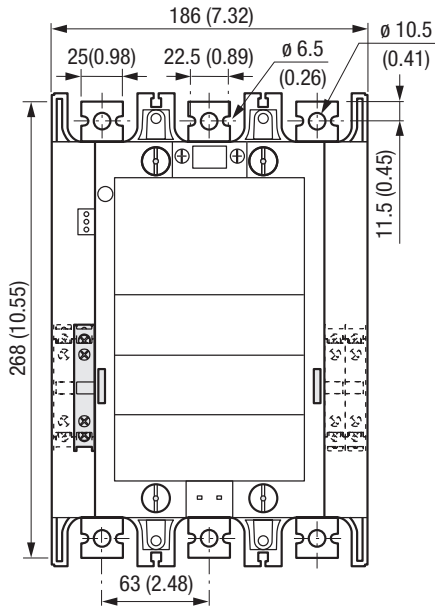

**Series CA9-580-EI, CA9-750-EI (Contactors/Reversing Contactors with PLC Interface)**

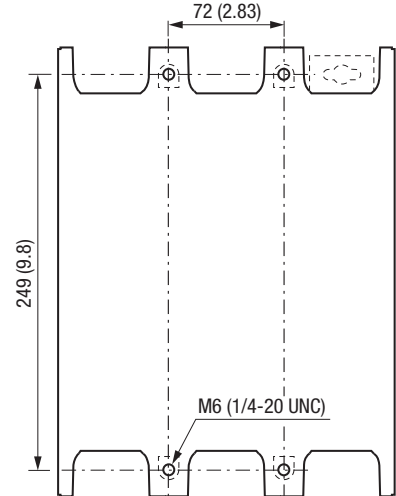
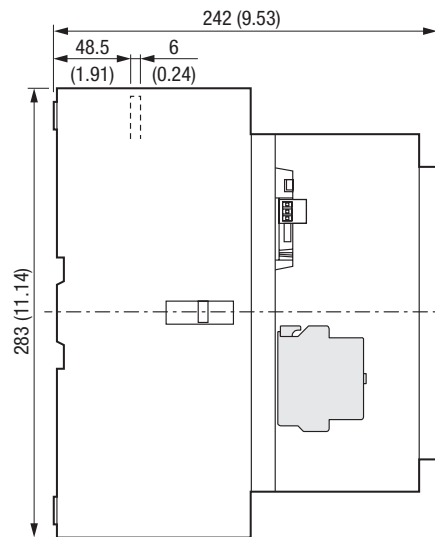
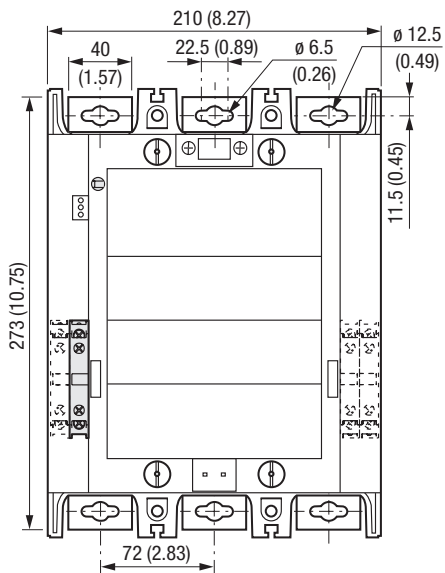

**Series CA9-1260-EI (Contactors with PLC Interface)**

Dimensions are in millimeters (inches). Dimensions not intended for manufacturing purposes.

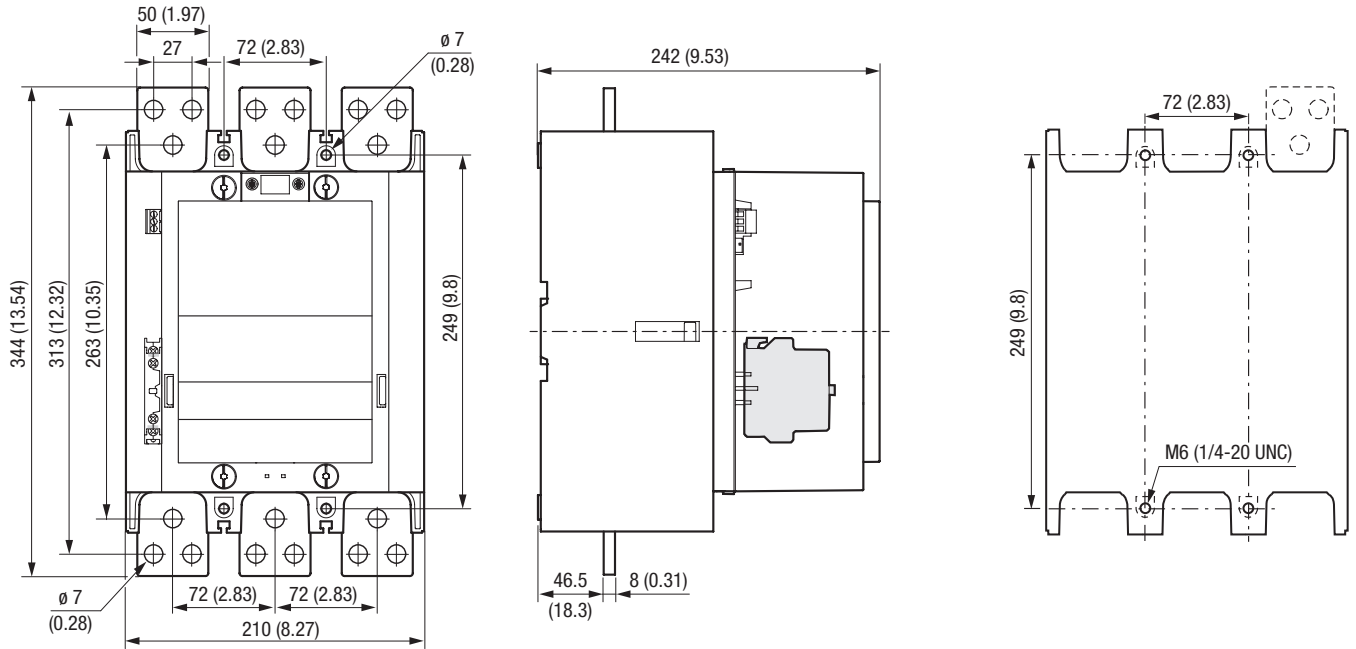

**Series CA9-860-EI, CA9-1060-EI, CA9-2050-EI, CA9-2650-EI (Contactors with PLC Interface)**

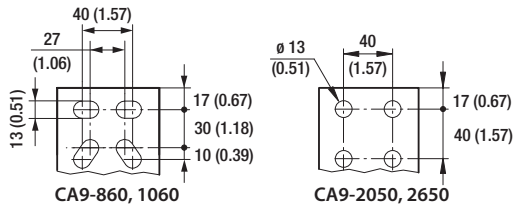

Dim	CA9-860, 1060, 2050	CA9-2650
A	392 (15.43)	422 (16.61)
B	47 (1.85)	53 (2.09)
C	10 (0.39)	25 (0.98)

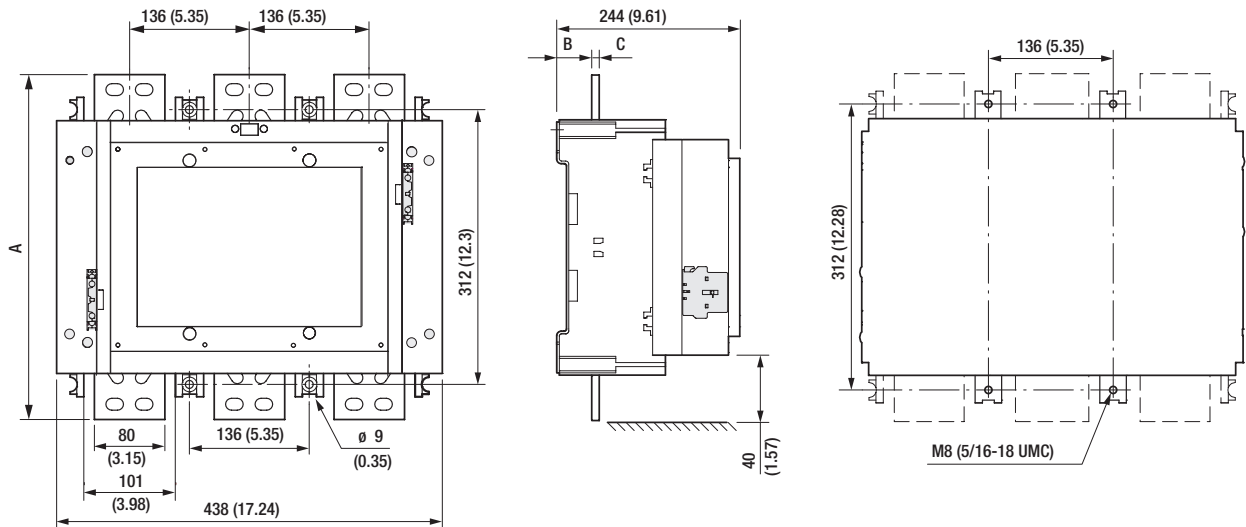



# Series CA6 Contactors

CA6 Contactors

A classic contactor for demanding applications from 75 to 600HP (@460V) - 100 to 700HP (@ 575V)

Sprecher + Schuh's CA6 contactor line combines the simple function of our popular CA7 series with the rugged performance demanded in this middle horsepower range. On average these contactors are 50% smaller than traditional contactors in this size class.

## A broad selection for middle horsepower applications

The CA6 range consists of nine contactors in three frame sizes covering motors from 75 to 600HP at 460V and from 100 to 700HP at 575V. This line is ideally suited for demanding applications such as steel mills, rock quarries, mines or for any middle horsepower application where a sturdy, durable contactor is needed.



## Rugged and reliable

CA6 contactors conform to UL508, IEC 60947 and can be operated at rated voltages up to 600V (UL) and 1000V (IEC). High thermal and switching capacities guarantee reliable operation and long life. CA6 contactors are listed in CSA Certified Elevator Equipment for heavy duty use in elevators, refrigerators and heating installations in Canada.

## Arc quenching extends contact life

All CA6 contactors are designed with sophisticated arc quenching techniques that extinguish damaging breaking arcs quickly. This is accomplished by guiding the arc away from the contacts and into "arc chambers" which are built-in to every CA6 cover.

## Safety first

CA6 arc chambers are completely enclosed (without arc exhaust vents), offering the best protection against hot arcing gases. A large safety distance in front of the contactor is unnecessary. CA6 contactors are also designed so that operation is impossible if the arc chambers are removed. Conversely, once the contactor is energized, the arc chambers cannot be removed.

When used with terminal covers or HB Touch-Safe Lugs, CA6 contactors meet international standards for touch-safe design.

**DISCONTINUED**  
This series is being replaced by the CA9 Series of contactors

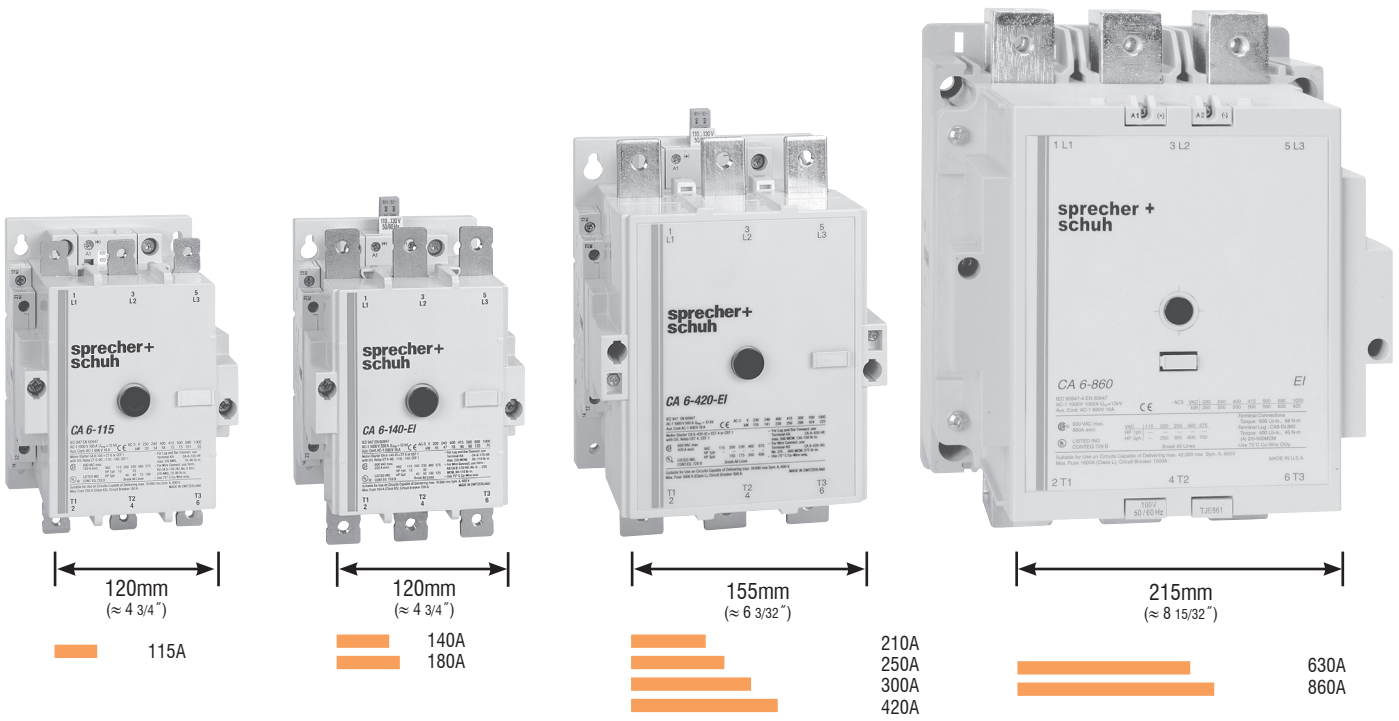

## Electronic coils offer many advantages

Behind the attractive outward appearance of the CA6 contactor are advanced engineering solutions that offer convenience and savings. The entire line can be equipped with an electronically controlled coil that reduces pick-up currents by 60% on average. Holding current is also reduced.

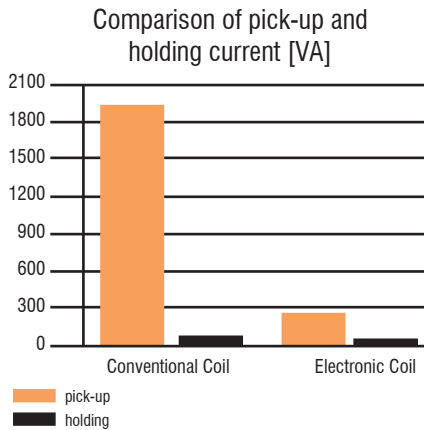

Other advantages of the CA6 electronic coil include:

- Direct connection to a PLC
- Overvoltage protection and suppression circuits (eliminating interference from the coil) are standard

The entire CA6 line is modularly designed for easy inspection, coil change and contact replacement. Maintenance can be performed from the front so that mounting requires no additional space. Even with the installation of mechanical interlocks and auxiliary contact blocks, the units can be flush mounted side by side, saving panel space.

- 1 CA6-115-EI Contactor
- 2 CA6-140-EI Contactor
- 3 Main Terminal Set
- 4 Lug set
- 5 Mechanical Interlock
- 6 Aux. Contact Block
- 7 Aux. Contact Block
- 8 Aux. Contact Block
- 9 Aux. Contact Block
- 10 Terminal Cover
- 11 Surge Suppressor

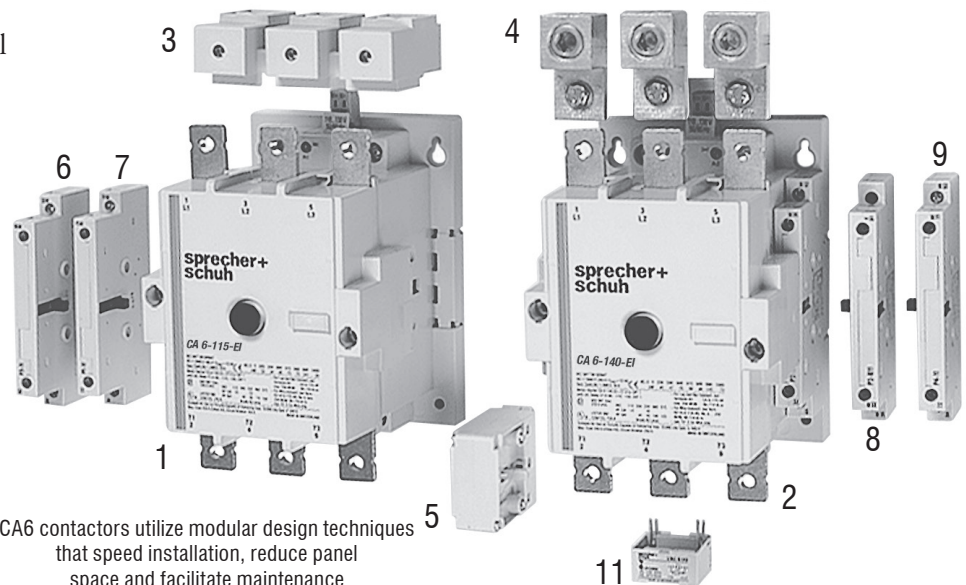

CA6 contactors utilize modular design techniques that speed installation, reduce panel space and facilitate maintenance

**DISCONTINUED**

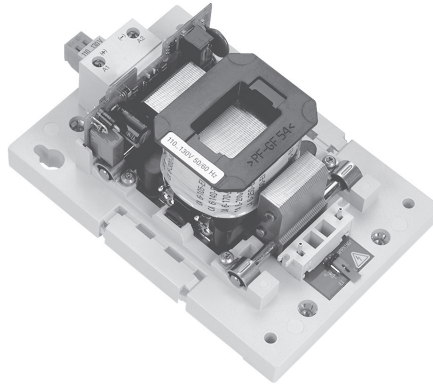

CA6 “EI” electronic coils offer many unique advantages over conventional types

- Smooth, even operation over the entire voltage range minimizes the possibility of contact bounce
- No safeguards are necessary to bridge brief supply interruptions
- Precisely defined pick-up and drop-out voltages, eliminate the possibility of chattering
- Electronic coils operate over a much broader voltage range, providing flexibility in applications and lower costs due to reduced inventory

## Two user-selectable modes

CA6 contactors with electronic coils operate in either the “E” mode for normal operation or the “EI” mode for interfacing directly with a Programmable Logic Controller (PLC) or other low level signal source (13...30.2 VDC). The coil is set in the “E” mode from the factory, offering all of the functions and advantages of an electronic coil with the exception of electronic interface. An orange “jumper” located on the bottom of the contactor can be quickly changed if interface from a PLC is desired. A detailed technical explanation of CA6-EI coils along with connection diagrams can be found in the Technical Section.

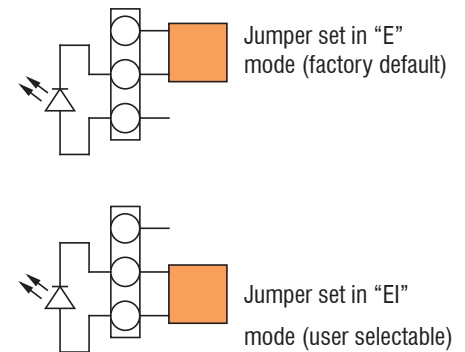

**Non-Reversing, Three Pole Contactors With AC Coil, Series CA6 (Open type only) ①③**

I <sub>e</sub> [A]		Ratings for Switching AC Motors (AC2 / AC3)										Auxiliary Contacts per Contactor		Open Type	
		kW (50 Hz)				UL/CSA HP (60 Hz)									
		230V	400V/415V	500V	690V	1 Ø		3 Ø							
AC-3	AC-1					230V	400V/415V	500V	690V	115V	230V	200V	230V	460V	575V
115	250	37	64/66	80	111	10	25	40	40	75	100	1	1	CA6-115-11-* CA6-115-EI-11-*	694.86 836.12
140	250	45	78/82	80 ④	111	15	30	40	50	100	125	1	1	CA6-140-11-* CA6-140-EI-11-*	1142.52 1298.32
180	250	57	101/105	98 ④	135 ④	~	40	50	60	150	150	1	1	CA6-180-11-* CA6-180-EI-11-*	1599.53 1817.65
210	350	67	118/122	147	205	~	50	60	75	150	200	1	1	CA6-210-EI-11-*	1921.52
250	350	80	140/145	177	250	~	~	75	100	200	250	1	1	CA6-250-EI-11-*	2170.80
300	450	97	170/176	213	293	~	~	100	125	250	300	1	1	CA6-300-EI-11-*	2420.07
420	540	135	238/250	298	424	~	~	150	175	350	400	1	1	CA6-420-EI-11-*	5110.20
630	800	200	355	450	500	~	~	200	250	500	600	1	1	CA6-630-EI-11-*	9109.04
860	1000	250	500	560	~	~	~	250	300	600	700	1	1	CA6-860-EI-11-*	12360.04



CA6-140-EI contactor



CA6-420-EI contactor

**Note:** CA6 open-type contactors include terminal bolts. If lugs are required, see page A129 for ordering information.

**Coil Codes ②**

CA6-115 /140 /180		
AC Coil Code	Voltage Range	
	50 Hz	60 Hz
24	~	24V
120B	110V	120V
208	~	208V
240B	220-230V	240V
277	240V	277V
380	380-400V	440V
480	415V	480V
575	500V	575V

CA6-115-EI ...CA6-420-EI ①	
AC Coil Code	Voltage Range
	50 Hz / 60 Hz
24 ⑤	24V
120	110-130V
220W	208-277V
460W	380-500V

CA6-630-EI ...CA6-860-EI ①	
AC Coil Code	Voltage Range
	50 Hz / 60 Hz
120	110-130V ⑥
208W	200-220V
240W	230-250V ⑥
277	277V
480	440-480V

CA6 "EI" coils are electronically controlled coils with the following characteristics:

- Ability to connect directly to a low level signal source such as a PLC (13-30 VDC at 15mA max.)
- Very low pull-in and holding current for contactors in this size class
- Threshold voltages for pull-in and drop-out are very precisely defined, eliminating "chattering"
- Supply voltage dips are bridged without extra equipment
- "EI" coils cover a much wider voltage range with only one coil

**Ordering Instructions**

Specify Catalog Number	
Replace (*) with Coil Code	<b>See Coil Codes on this page</b>

- ① "EI" designates contactor with Electronic Interface coil.
- ② Other voltages available, see page A134-A135.
- ③ For CSA Elevator duty rating, consult Technical Information on page A139.
- ④ Ratings are higher for contactors with electronic coil:  
CA6-140-EI-11-\*    CA6-180-EI-11-\*  
500V = 98 kW      500V = 126 kW  
690V = 135 kW    690V = 176 kW
- ⑤ 24 VAC Coil is not available for CA6-420-EI.
- ⑥ Coil is rated AC/DC.

**Non-Reversing, Three Pole Contactors With DC Coil, Series CA6 (Open type only) ①③**

I <sub>e</sub> [A]		Ratings for Switching AC Motors (AC2 / AC3)										Auxiliary Contacts per Contactor		Open Type		Price
		kW (50 Hz)				UL/CSA HP (60 Hz)										
		AC-3	AC-1	230V	400V/415V	500V	690V	1 Ø		3 Ø						
115V	230V							200V	230V	460V	575V	NO	NC			
115	250	37	64/66	80	111	10	25	40	40	75	100	1	1	CA6-115-L22-* CA6-115-EI-11-*	836.12	
140	250	45	78/82	80 ④	111	15	30	40	50	100	125	1	1	CA6-140-L22-* CA6-140-EI-11-*	1298.32	
180	250	57	101/105	98 ④	135 ④	~	40	50	60	150	150	1	1	CA6-180-L22-* CA6-180-EI-11-*	1817.65	
210	350	67	118/122	147	205	~	50	60	75	150	200	1	1	CA6-210-EI-11-*	1921.52	
250	350	80	140/145	177	250	~	~	75	100	200	250	1	1	CA6-250-EI-11-*	2170.80	
300	450	97	170/176	213	293	~	~	100	125	250	300	1	1	CA6-300-EI-11-*	2420.07	
420	540	135	238/250	298	424	~	~	150	175	350	400	1	1	CA6-420-EI-11-*	5110.20	
630	800	200	355	450	500	~	~	200	250	500	600	1	1	CA6-630-EI-11-*	9109.04	
860	1000	250	500	560	~	~	~	250	300	600	700	1	1	CA6-860-EI-11-*	12360.04	



CA6-140-EI contactor with DC coil

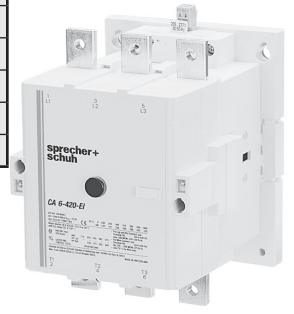

CA6-420-EI contactor with DC coil

**Note:** CA6 open-type contactors include terminal bolts. If lugs are required, see page A129 for ordering information.

**Coil Codes ②**

CA6-115 / 140 / 180	
DC Coil Code	Voltage Range
24D	24V
110D	110V
220D	220V

CA6-115-EI...CA6-420-EI ①	
DC Coil Code	Voltage Range
24D ⑤	24V
120D	110-130V
220D	200-255V

CA6-630...CA6-860-EI ①	
DC Coil Code	Voltage Range
120	110-130V ⑤
240W	200-255V ⑤

**Note:** Conventional DC coils have high current pick-up winding and low current "seal-in" winding wired in parallel. The pick-up winding is taken out of the circuit after the armature pulls in. Price includes two winding coil and an L11 block including one NC late break auxiliary contact mounted on the right side. See page A149 for functional schematic.

CA6 "EI" coils are electronically controlled coils with the following characteristics:

- Ability to connect directly to a low level signal source such as a PLC (13-30 VDC at 15mA max.)
- Very low pull-in and holding current for contactors in this size class
- Threshold voltages for pull-in and drop-out are very precisely defined, eliminating "chattering"
- Supply voltage dips are bridged without extra equipment
- "EI" coils cover a much wider voltage range with only one coil

**Ordering Instructions**

Specify Catalog Number	
Replace (*) with Coil Code	See Coil Codes on this page

- ① "-EI" designates contactor with Electronic Interface coil.
- ② Other voltages available, see page A134-A135.
- ③ For CSA Elevator duty rating, consult Technical Information on page A139.
- ④ Ratings are higher for contactors with electronic coil:  
CA6-140-EI-11-\*    CA6-180-EI-11-\*  
500V = 98 kW      500V = 126 kW  
690V = 135 kW     690V = 176 kW
- ⑤ 24V DC Coil not available for CA6-420-EI. Customers selecting 24V DC Coils should consider the "EI" functionality of the CA6 (see page A148).
- ⑥ Coil is rated AC/DC.

### Reversing, Three Pole Contactors With AC Coil, Series CA6 (Open type only) ⑥

I <sub>e</sub> [A]		Ratings for Switching AC Motors (AC2 / AC3)										Auxiliary Contacts per Contactor		Open Type	
		kW (50 Hz)				UL/CSA HP (60 Hz)									
		230V	400V/415V	500V	690V	1 Ø		3 Ø							
115V	230V					200V	230V	460V	575V						
AC-3	AC-1	230V	400V/415V	500V	690V	115V	230V	200V	230V	460V	575V	NO	NC	Catalog Number ①⑥	Price
115	250	37	64/66	80	111	10	25	40	40	75	100	1	1	CAU6-115-22-* CAU6-115-EI-22-*	1963.06 2139.64
140	250	45	78/82	80 ⑦	111	15	30	40	50	100	125	1	1	CAU6-140-22-* CAU6-140-EI-22-*	2814.76 3147.14
180	250	57	101/105	98 ⑦	135 ⑦	~	40	50	60	150	150	1	1	CAU6-180-22-* CAU6-180-EI-22-*	3413.98 4206.57
210	350	67	118/122	147	205	~	50	60	75	150	200	1	1	CAU6-210-EI-22-*	4850.54
250	350	80	140/145	177	250	~	~	75	100	200	250	1	1	CAU6-250-EI-22-*	5349.09
300	450	97	170/176	213	293	~	~	100	125	250	300	1	1	CAU6-300-EI-22-*	5920.35
420	540	135	238/250	298	424	~	~	150	175	350	400	1	1	CAU6-420-EI-22-*	11217.51
630	800	200	355	450	500	~	~	200	250	500	600	1	1	CAU6-630-EI-22-*	20253.84
860	1000	250	500	560	~	~	~	250	300	600	700	1	1	CAU6-860-EI-22-*	26797.39

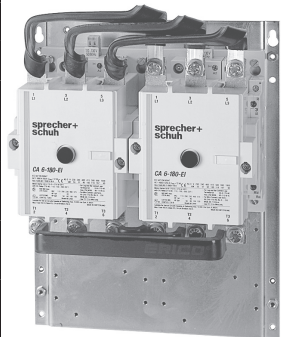

CAU6-180 reversing contactor

#### Includes:

- Mechanical and electrical Interlock ④
- Reversing power wiring (using Power Wiring Kit Cat.# CA6-...VL[T]) ①
- Mounting plate
- Control wiring available; see footnote ②

**Note:** CA6 open-type contactors include terminal bolts. If lugs are required, see page A129 for ordering information.

### Coil Codes ②

CA6-115 /140 180		
AC Coil Code	Voltage Range	
	50 Hz	60 Hz
24	~	24V
120B	110V	120V
208	~	208V
240B	220-230V	240V
277	240V	277V
380	380-400V	440V
480	415V	480V
575	500V	575V

CA6-115-EI ...CA6-420-EI ①	
AC Coil Code	Voltage Range
	50 Hz / 60 Hz
24 ③	24V
120	110-130V
220W	208-277V
460W	380-500V

CA6-630-EI ...CA6-860-EI ①	
AC Coil Code	Voltage Range
	50 Hz / 60 Hz
120	110-130V ③
208W	200-220V
240W	230-250V ③
277	277V
480	440-480V

① For -LW Option Deduct the following from List Price	
CAU6-115...180	181.77
CAU6-210...860	373.92
② For -CW Option Add the following to List Price	
All CAU6	20.73

### Ordering Instructions

Specify Catalog Number	
Replace (*) with Coil Code	See Coil Codes on this page

CA6 "EI" coils are electronically controlled coils with the following characteristics:

- Ability to connect directly to a low level signal source such as a PLC (13-30 VDC at 15mA max.)
- Very low pull-in and holding current for contactors in this size class
- Threshold voltages for pull-in and drop-out are very precisely defined, eliminating "chattering"
- Supply voltage dips are bridged without extra equipment
- "EI" coils cover a much wider voltage range with only one coil

- ① For Reversing Contactors without power wiring add suffix "-LW" to catalog number. For example: CAU6-115-22-\* becomes CAU6-115-22-\*LW. Control wiring is not included.
- ② For control wiring, add suffix -CW to catalog number. For example: CAU6-115-22-\* becomes CAU6-115-22-\*CW.
- ③ "-EI" designates contactor with Electronic Interface coil.
- ④ One NC auxiliary contact on each contactor is used for electrical interlocking.
- ⑤ Other voltages available, see page A134-A135.
- ⑥ For CSA Elevator duty rating, consult Technical Information on page A139.
- ⑦ Ratings are higher for contactors with electronic coil:
 

CA6-140-EI-11-*	CA6-180-EI-11-*
500V = 98 kW	500V = 126 kW
690V = 135 kW	690V = 176 kW
- ⑧ 24 VAC Coil is not available for CA6-420-EI.
- ⑨ Coil is rated AC/DC.

**Reversing, Three Pole Contactors With DC Coil, Series CA6 (Open type only) ⑥**

I <sub>e</sub> [A]		Ratings for Switching AC Motors (AC2 / AC3)										Auxiliary Contacts per Contactor		Open Type	
		kW (50 Hz)				UL/CSA HP (60 Hz)									
		AC-3	AC-1	230V	400V/415V	500V	690V	1 Ø		3 Ø					
115V	230V							200V	230V	460V	575V				
115	250	37	64/66	80	111	10	25	40	40	75	100	2	1	CAU6-115-L42-* CAU6-115-EI-22-*	2285.05 2513.55
140	250	45	78/82	80 ⑦	111	15	30	40	50	100	125	2	1	CAU6-140-L42-* CAU6-140-EI-22-*	3354.87 3780.72
180	250	57	101/105	98 ⑦	135 ⑦	~	40	50	60	150	150	1	1	CAU6-180-L42-* CAU6-180-EI-22-*	4528.55 5099.81
210	350	67	118/122	147	205	~	50	60	75	150	200	1	1	CAU6-210-EI-22-*	5785.33
250	350	80	140/145	177	250	~	~	75	100	200	250	1	1	CAU6-250-EI-22-*	6408.52
300	450	97	170/176	213	293	~	~	100	125	250	300	1	1	CAU6-300-EI-22-*	7104.42
420	540	135	238/250	298	424	~	~	150	175	350	400	1	1	CAU6-420-EI-22-*	13606.43
630	800	200	355	450	500	~	~	200	250	500	600	1	1	CAU6-630-EI-22-*	20253.84
860	1000	250	500	560	~	~	~	250	300	600	700	1	1	CAU6-860-EI-22-*	26797.39

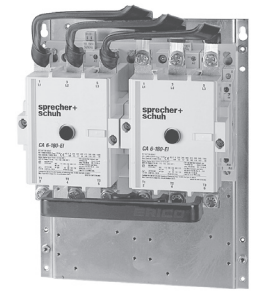

CAU6-180 reversing contactor with DC coil

**Includes:**

- DC operating mechanism
- Mechanical and electrical Interlock ④
- Reversing power wiring (using Power Wiring Kit Cat.# CA6-...VL[T]) ①
- Mounting plate
- Control wiring available; see footnote ②

**Note:** CA6 open-type contactors include terminal bolts. If lugs are required, see page A129 for ordering information.

**Coil Codes ⑤**

CA6-115 / 140 / 180	
DC Coil Code	Voltage Range
24D	24V
110D	110V
220D	220V

**Note:** Conventional DC coils have high current pick-up winding and low current "seal-in" winding wired in parallel. The pick-up winding is taken out of the circuit after the armature pulls in. Price includes two winding coil and an L11 block including one NC late break auxiliary contact mounted on the right side. See page A149 for functional schematic.

CA6-115-EI...CA6-420-EI ①③	
DC Coil Code	Voltage Range
24D ⑥	24V
120D	110-130V
220D	200-255V

CA6-630...CA6-860-EI ①③	
DC Coil Code	Voltage Range
120	110-130V ⑥
240W	200-255V ⑥

① For -LW Option Deduct the following from List Price	
CAU6-115...180	181.77
CAU6-210...860	373.92
② For -CW Option Add the following to List Price	
All CAU6	20.73

CA6 "EI" coils are electronically controlled coils with the following characteristics:

- Ability to connect directly to a low level signal source such as a PLC (13-30 VDC at 15mA max.)
- Very low pull-in and holding current for contactors in this size class
- Threshold voltages for pull-in and drop-out are very precisely defined, eliminating "chattering"
- Supply voltage dips are bridged without extra equipment
- "EI" coils cover a much wider voltage range with only one coil

- ① For Reversing Contactors *without* power wiring add suffix "-LW" to catalog number. For example: CAU6-115-22-\* becomes CAU6-115-22-\***-LW**. Control wiring is not included.
- ② For control wiring, add suffix **-CW** to catalog number. For example: CAU6-115-22-\* becomes CAU6-115-22-\***-CW**.
- ③ "EI" designates contactor with Electronic Interface coil.
- ④ One NC auxiliary contact on each contactor is used for electrical interlocking.
- ⑤ Other voltages available, see page A134-A135.
- ⑥ For CSA Elevator duty rating, consult Technical Information on page A139.
- ⑦ Ratings are higher for contactors with electronic coil:  
CA6-140-EI-11-\*    CA6-180-EI-11-\*  
500V = 98 kW      500V = 126 kW  
690V = 135 kW     690V = 176 kW
- ⑧ 24V DC Coil not available for CA6-420-EI. Customers selecting 24V DC Coils should consider the "EI" functionality of the CA6 (see page A148).
- ⑨ Coil is rated AC/DC

**Ordering Instructions**

Specify Catalog Number	
Replace (*) with Coil Code	See Coil Codes on this page

### Non-Reversing, Three Pole NEMA Labeled Contactors with AC Coil ①③

NEMA Size	Maximum Horsepower						Standard Auxiliary Contacts		Catalog Number	Price
	1Ø		3Ø				NO	NC		
	115V	230V	200V	230V	460V	575V				
00	1/3	1	1-1/2	1-1/2	2	2	1	0	CAN7-12-10-*	See page A42
0	1	2	3	3	5	5	1	0	CAN7-16-10-*	
1	2	3	7-1/2	7-1/2	10	10	1	0	CAN7-37-10-*	
2	3	7-1/2	10	15	25	25	1	0	CAN7-43-10-*	
3	7-1/2	15	25	30	50	50	1	0	CAN7-85-10-*	
4	~	~	40	50	100	100	1	1	CAN6-180-11-*	2723.96
									CAN6-180-EI-11-*	3159.29
5	~	~	75	100	200	200	1	1	CAN6-300-EI-11-*	6767.39



CAN6 NEMA labeled contactor (AC)



#### Application Notes

- NEMA contactors are UL Listed and rated in accordance with the requirements of NEMA standards publication ICS-2. These contactors are labeled for applications that require compliance with NEMA standards.
- Sizes are based on standard NEMA classifications.
- Easy coil change and contact replacement. See pages A134-A135 for coils and contacts.
- Snap-on auxiliary contact blocks available in many configurations. See page A132 (CA[N]6).

**Note:** CA6 open-type contactors include terminal bolts. If lugs are required, see page A129 for ordering information.

#### CAN6 AC Coil Codes Conventional Coils ②

AC Coil Code	CAN6-180 Voltage Range	
	50 Hz	60 Hz
	24	~
120B	110V	120V
208	~	208V
240B	220-230V	240V
277	240V	277V
380	380V-400V	440V
480	415V	480V
575	500V	575V

#### CAN6 AC Coil Codes “EI” Electronic Coils ②③

AC Coil Code	CAN6-180-EI...300-EI Voltage Range
	50 Hz / 60 Hz
	24
120	110-130V
220W	208-277V
460W	380-500V

#### Ordering Instructions

Specify Catalog Number	
Replace (*) with Coil Code	See Coil Codes on this page.

- ① Refer to page A154 for CAN6 dimensions.
- ② Other voltages available, see pages A134-A135 for CAN6 coils.
- ③ “EI” designates contactor with Electronic Interface coil.

**Non-Reversing, Three Pole NEMA Labeled Contactors with DC Coil ❶**

NEMA Size	Maximum Horsepower						Standard Auxiliary Contacts		Catalog Number	Price
	1Ø		3Ø				NO	NC		
	115V	230V	200V	230V	460V	575V				
00	1/3	1	1-1/2	1-1/2	2	2	1	0	CAN7-12E-10-* ❸	See page A43
0	1	2	3	3	5	5	1	0	CAN7-16E-10-* ❸	
1	2	3	7-1/2	7-1/2	10	10	1	0	CAN7-37E-10-* ❸	
2	3	7-1/2	10	15	25	25	1	0	CAN7-43E-10-* ❸	
3	7-1/2	15	25	30	50	50	2	1	CAN7-85D-10-*	
4	~	~	40	50	100	100	1	1	CAN6-180-L22-* ❶	3060.83
									CAN6-180-EI-11-* ❸❹	3159.29
5	~	~	75	100	200	200	1	1	CAN6-300-EI-11-* ❸❹	6767.39



CAN6 NEMA labeled contactor



**A**  
CAN6 Contactors

**Application Notes**

- NEMA contactors are UL Listed and rated in accordance with the requirements of NEMA standards publication ICS-2. These contactors are labeled for applications that require compliance with NEMA standards.
- Sizes are based on standard NEMA classifications.
- Easy coil change and contact replacement. See pages A134-A135 for coils and contacts.
- Snap-on auxiliary contact blocks available in many configurations. See page A132.

**Note:** CA6 open-type contactors include terminal bolts. If lugs are required, see page A129 for ordering information.

**CAN6 DC Coil Codes**

**Conventional Coils ❷❹**

CAN6-180-L22	
DC Coil Code	Voltage Range
24D	24V

**CAN6 DC Coil Codes**

**"EI" Electronic Coils ❷❹**

CAN6-180-EI...300-EI	
DC Coil Code	Voltage Range
24D	24V

**Ordering Instructions**

Specify Catalog Number	
Replace (*) with Coil Code	<b>See Coil Codes on this page.</b>

- ❶ Refer to page A154 for CAN6 dimensions.
- ❷ Other voltages available, see pages A134-A135 for CAN6 coils.
- ❸ "-EI" designates contactor with Electronic Interface coil.
- ❹ Customers with 24VDC applications should strongly consider using the "EI" functionality of the CA6 (see pages A148-A149).



#### Hydraulic Elevator Wye Delta, with AC Coils (Two Contactor Type ①②⑤)

Maximum Horsepower Three Phase				Auxiliary Contacts per Contactor		Open Type	Price
200V	230V	460V	575V	NO	NC ③	Catalog No.	
60 40	60 50	125 100	150 125	1	1	CA6Y2-115-22-∗-LW CA6Y2-115-EI-22-∗-LW	1654.59 1848.81
60 50	75 60	175 125	200 125	1	1	CA6Y2-140-22-∗-LW CA6Y2-140-EI-22-∗-LW	2578.99 2911.36
75 60	100 75	200 150	250 150	1	1	CA6Y2-180-22-∗-LW CA6Y2-180-EI-22-∗-LW	3520.02 3535.60

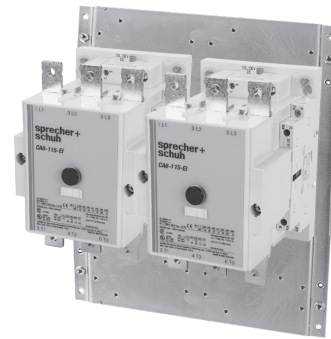

CA6Y2-115 Wye-Delta contactor

**Includes:**

- Mechanical and electrical Interlocks ③
- Mounting plate

**Optional:**

- Power wiring available but not included (see page A130) ①⑦

HP Selection	
Industrial Application ⑤	CSA Elevator Duty ⑥

Larger sizes are possible. Contact your Sprecher + Schuh representative.

CA6 “EI” coils are electronically controlled coils with the following characteristics:

- Ability to connect directly to a low level signal source such as a PLC (13-30 VDC at 15mA max.)
- Very low pull-in and holding current for contactors in this size class
- Threshold voltages for pull-in and drop-out are very precisely defined, eliminating “chattering”
- Supply voltage dips are bridged without extra equipment
- “EI” coils cover a much wider voltage range with only one coil

#### Coil Codes ④

CA6-115...180		
AC Coil Code	Voltage Range	
	50 Hz	60 Hz
24	~	24V
120B	110V	120V
208	~	208V
240B	220-230V	240V
277	240V	277V
380	380-400V	440V
480	415V	480V
575	500V	575V

CA6-115-EI ...CA6-180-EI ①		
AC Coil Code	Voltage Range	
	50 Hz / 60 Hz	
24	24V	
120	110-130V	
220W	208-277V	
440W	380-440V	

① For -PW Option Add the following to List Price		
CA6Y2-115...180	283.56	

CA6-180-VYU

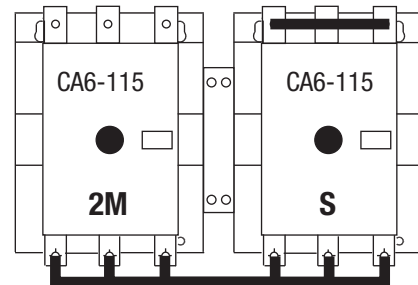

CA6-180-VLHB

#### Ordering Instructions

Specify Catalog Number	
Replace (∗) with Coil Code	See Coil Codes on this page.

① For Contactors *with* power wiring add suffix “-PW” to catalog number. For example: CA6Y2-115-22-∗-LW becomes CA6Y2-115-22-∗-PW. Control wiring is not included.

② “EI” designates contactor with Electronic Interface coil.

③ One NC auxiliary contact on each contactor is used for electrical interlocking.



④ Other voltages available, see page A134-A135.

⑤ HP selection based on UL508 for Industrial Applications.

⑥ HP selection based on CSA Elevator Duty Ratings.

⑦ See typical Wye-Delta Wiring Diagram on page C117.

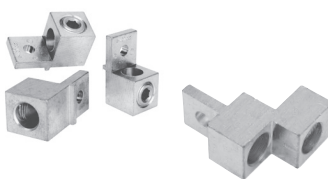
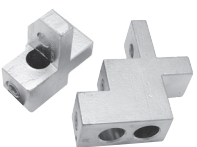
**Main Lugs and Lug Accessories**





Lug or Accessory	Connection	Description	Catalog Number	Price
 <p>Multiple conductors (flat or round) fit in each terminal on CA6-HB Main Terminal Sets (top view)</p>	<ul style="list-style-type: none"> <li>Accommodation for dual connections to each pole</li> <li>Accepts flat or round conductors</li> <li>Touch safe to IP20 according to IEC 60529</li> <li>Eliminates need for Terminal Shields</li> </ul> <p>Main Terminal Sets (catalog #: CA6-HB...) are specifically designed for connecting line and load to all three poles on CA6 contactors. Each touch safe terminal set contains three built-in terminals capable of carrying two round conductors or multiple flat conductors. Main Terminal Sets add a clean finished appearance to CA6 contactors</p>	<p><b>Main Terminal Set, Dual Conductor, Touch Safe</b> (price as complete set, containing 2 blocks, 6 lugs)</p> <p>For CA6-115(-EI); 140(-EI); 180(-EI)</p> <p>For CA6-210-EI to 420-EI</p>	<p><b>CA6-HB2</b></p> <p><b>CA6-HB3</b></p>	<p><b>129.83</b></p> <p><b>195.27</b></p>
	<p><b>Screw Type Lugs -</b></p> <ul style="list-style-type: none"> <li>Single connections to each pole</li> <li>Accepts round conductors only</li> <li>Copper construction</li> </ul> <p>(set of 3 - two sets required to wire line and load sides)</p>	<p>For CA6-115(-EI); 140(-EI); 180(-EI)</p> <p>For CA6-210-EI to CA6-420-EI</p>	<p><b>CA6-L180</b></p> <p><b>CA6-L420</b></p>	<p><b>85.17</b></p> <p><b>185.92</b></p>
	<p><b>Screw Type Lugs -</b></p> <ul style="list-style-type: none"> <li>Accommodation for dual connections to each pole</li> <li>Accepts round conductors only</li> <li>Copper construction</li> </ul> <p>(set of 3 - two sets required to wire line and load sides)</p>	<p>For CA6-630-EI</p>	<p><b>CA6-L630</b></p>	<p><b>327.18</b></p>
	<p><b>Screw Type Lugs -</b></p> <ul style="list-style-type: none"> <li>Accommodation for dual connections to each pole</li> <li>Accepts round conductors only</li> <li>Copper construction</li> </ul> <p>(set of 3 - two sets required to wire line and load sides)</p>	<p>For CA6-860-EI</p>	<p><b>CA6-L860</b></p>	<p><b>473.63</b></p>
 <p>(Typical)</p>	<p><b>Control Wire Terminal ①</b> 2 x 2.5mm<sup>2</sup></p>	<p>For CA6-115(-EI); 140(-EI); 180(-EI)</p> <p>For CA6-210-EI to 420-EI</p>	<p><b>CA6-AT1</b></p> <p><b>CA6-AT2</b></p>	<p><b>5.47</b></p> <p><b>14.96</b></p>

① The IP2X lug rating will no longer apply if used with CA6-HB\_ main terminal set.



See Page A145 for terminal wire ranges.

**A**  
CA6 Contactors

**Power Wiring Connection Kits**







Connection Kits	Application	Used with contactor...	Use with Lug...	Catalog Number	Price
 CA6-180-VLHB	<b>Reversing Line Side Wye-Delta Line Side</b> Connects L1-L1 L2-L2 L3-L3	CA6-115(-EI) to 180(-EI)	CA6-L180	CA6-180-VLHB	118.41
		CA6-115(-EI) to 180(-EI)	CA6-HB2		
		CA6-210-EI to 420-EI	CA6-HB3	CA6-420-VLHB	284.59
			CA6-420-HU CA6-L420		
CA6-630-EI to 860-EI	CA6-L630 CA6-L860	CA6-860-VL	545.30		
 CA6-180-VT	<b>Reversing Load Side</b> Connect T1-T3 T2-T2 T3-T1	CA6-115(-EI) to 180(-EI)	CA6-L180	CA6-180-VT	153.73
		CA6-115(-EI) to 180(-EI)	CA6-HB2	CA6-180-VTHB	153.73
		CA6-210-EI to 420-EI	CA6-HB3	CA6-420-VTHB	286.67
		CA6-210-EI to 420-EI	CA6-420-HU CA6-L420	CA6-420-VT	273.17
		CA6-630-EI to 860-EI	CA6-L860	CA6-860-VT	500.63
 CA6-180-VYU	<b>Wye-Delta Shorting Bar</b>	CA6-115(-EI) to 180(-EI) CA6-210-EI to 420-EI	N/A	CA6-180-VYU CA6-420-VYU	15.48 31.47
		CA6-630-EI to 860-EI	N/A	CA6-860-VYU	62.00
 CA6-420-VT	<b>Wye-Delta (2M to S jumper)</b>	Connects 2M contactor CA6-210-EI to 420-EI... to S contactor CA6140(-EI) to 180(-EI)	CA6-HB3	CA6-420-VYHB	243.05
		Connects 2M contactor CA6-210-EI to 420-EI... to S contactor CA6-210-EI to 420-EI	CA6-420-HU CA6-L420	CA6-420-VT	273.17

**Lug Accessories and Backpans**

Accessory	Description	For use with contactor...	Catalog Number	Price	
	<b>Main Terminal Cover - ❶</b> • CA6 touch protection • Line or load (price each) • IP20; IEC60529 & DIN 40 050 protection	CA6-115(-EI) to 180(-EI)	<b>CA6-TC180</b>	46.42	
		CA6-210-EI to 420-EI	<b>CA6-TC420</b>	76.34	
		CA6-630-EI to 860-EI	<b>CA6-TC860</b>	111.13	
		CA6-630-EI to 860-EI	<b>CA6-TCS860 ❷</b>	52.14	
		CA6-630-EI to 860-EI	<b>CA6-TCR860 ❸</b>	435.20	
	<b>Mounting Plates –</b> 1 contactor & 1 O/L relay (Across-The-Line)	CA6-115(-EI)...180(-EI)	<b>CA6-MS180</b>	63.57	
		CA6-210-EI...420-EI	<b>CA6-MS420</b>	102.41	
		CA6-630-EI...860-EI	<b>CA6-MS860</b>	256.54	
		2 contactors & 2 O/L relays (Reversing or Multispeed)	CA6-115(-EI)...180(-EI)	<b>CA6-MU180</b>	102.41
			CA6-210-EI...420-EI	<b>CA6-MU420</b>	153.73
			CA6-630-EI...860-EI	<b>CA6-MU860</b>	311.60
	3 contactors, 2 O/L relays & 1 relay/timer (Wye-delta)	For CA6-115(-EI) to 180(-EI)	<b>CA6-MY180</b>	175.54	
		For CA6-210-EI to 420-EI	<b>CA6-MY420</b>	211.89	
		CA6-630-EI to 860-EI	<b>CA6-MY860</b>	368.72	

- ❶ Terminal Covers not necessary when using Main Terminal Sets (CA6-HB...) which are insulated.
- ❷ DOL starter/relay terminal covers
- ❸ Reversing starter/relay terminal cover
- ❹ Line-side panel relay and reversing terminal cover



#### Auxiliary Contact Blocks, 2 Pole

Auxiliary Contact Blocks	NO	NC	Contact Arrangement	Mounting Position	Catalog Number	Price
	1	1		Inside left or right	CA6-S1-11	46.22
	1	1		Outside left or right	CA6-S2-11	46.22
	1	1 LB		Inside left or right	CA6-S1-L11	53.49
	2	0		Inside left or right	CA6-S1-20	46.22
	2	0		Outside left or right	CA6-S2-20	46.22
	Form C Electronic Compatible				Inside left or right	CA6-S1-B11 ①

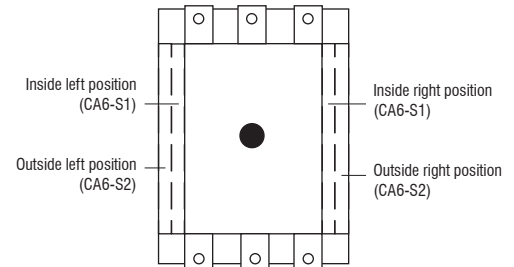
**NOTE:** Up to four auxiliary contact blocks (8 poles) may be mounted on the side of the CA6 contactor. One auxiliary contact block (1 NO + 1 NC) is mounted at the factory. New style CA6-115...140 contactors with conventional DC coils have an "-L11" mounted to right side and an "-11" mounted to left side at the factory.



#### Miscellaneous Accessories

Accessory	Description	For use with...	Catalog Number	Price
 CM6-D00	<b>Mechanical Interlock</b> • No built-in auxiliaries	Interlocks CA6 contactors	CM6-D00	57.02
 CM6-D02	<b>Mechanical / Electrical Interlock -</b> • Two built-in N.C. auxiliaries	Interlocks CA6 to CA7-60...97 contactors	CM6-C02	68.35
		Interlocks CA6 contactors	CM6-D02	68.35

① Electronic compatible auxiliary contacts function through the use of an internal micro-switch and have the following ratings:

**IEC 947 Data:**

AC-1	250V	0.1A
AC-15/DC-13 min.	3...125V	1...100mA

**UL 508, CSA 22.2 Data:**

Minimum Switching	250VAC max.	0.1A
	17V	5mA

**Miscellaneous Accessories**

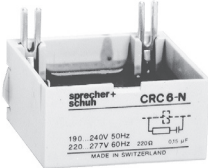
Accessory	Description	For use with...	Catalog Number	Price
	<b>Surge Suppressor</b> - Limits voltage spikes when switching off coil. Attaches to all CA6 contactors.  RC Link: 21-48V 50Hz / 24-55V 60Hz 95-110V 50 Hz / 110-127V 60 Hz 190-240V 50Hz / 220-277V 60Hz 380-550V 50Hz / 440-575V 60Hz	Conventional AC Coils	<b>CRC6-48</b> <b>CRC6-110</b> <b>CRC6-240</b> <b>CRC6-550</b>	38.02
	Varistor Link: 12-55V 50/60Hz 56-136V 50/60Hz 137-277V 50/60Hz 278-575V 50/60Hz	Conventional AC Coils	<b>CRV6-55</b> <b>CRV6-136</b> <b>CRV6-277</b> <b>CRV6-575</b>	24.30
	Varistor Link: 24-28V AC/DC 48-72V DC 43-65V 50/60Hz 208-277 50/60 Hz 380-400V 50/60Hz	Electronic (-EI) Coils ①	<b>CRV6-40</b> <b>CRV6-55</b> <b>CRV6-75</b> <b>CRV6-550</b> <b>CRV6-460</b>	24.30

**Marking Systems**

Component	Description	Pkg. Qty.	Catalog Number	Price Each
	<b>Label Sheet -</b> 1 sheet with 105 self-adhesive paper labels each, 6 x 17mm	1	<b>CA7-FMS</b>	See page A54
	<b>Marking Tag Sheet -</b> 1 sheet with 160 perforated paper labels each, 6 x 17mm. To be used with transparent cover	1	<b>CA7-FMP</b>	
	<b>Transparent Cover -</b> To be used with Marking Tag Sheets	100 ②	<b>CA7-FMC</b>	
	<b>Tag Carrier -</b> For marking with marker cards and tags. See page N35 for complete listing of available cards and tabs.	100 ②	<b>CA7-FMA2</b>	

① “EI” contactors are supplied with factory installed integrated surge protection (see page A135).

② Minimum order quantity is one package of 100. Price each x 100 = total price.

### Renewal Coils - A.C., Conventional Coil ❶

AC Control Voltages			AC Coil Codes	For use with contactor... CA6-95, CA6-110 CA6-115, CA6-140 CA(N)6-180	Optional RC Module ❷	Optional Varistor Module ❷
Conventional Coil						
50 Hz	60 Hz	50/60 Hz		Catalog No.	Catalog No.	Catalog No.
24V	~	~	24A	CA6-TG407	CRC6-48	CRV6-55
~	24V	~	24	CA6-TG013	CRC6-48	CRV6-55
32V	36V	~	~	CA6-TG481	CRC6-48	CRV6-55
42V	48V	~	48	CA6-TG482	CRC6-48	CRV6-55
48V	55V	~	48A	CA6-TG414	CRC6-48	CRV6-55
110V	120V	~	120B	CA6-TG473	CRC6-110	CRV6-136
~	208V	~	208	CA6-TG049	CRC6-240	CRV6-277
220-230V	240V	~	240B	CA6-TG441	CRC6-240	CRV6-277
240V	277V	~	277	CA6-TG480	CRC6-240	CRV6-277
380V-400V	440V	~	380	CA6-TG071	CRC6-880	CRV6-575
415V	480V	~	480	CA6-TG475	CRC6-550	CRV6-575
440V	508V	~	~	CA6-TG478	CRC6-550	CRV6-575
500V	575V	~	575	CA6-TG479	CRC6-550	CRV6-575
550V	600V	~	600	CA6-TG476	CRC6-550	CRV6-575
Price				184.89	See page A133 for pricing	

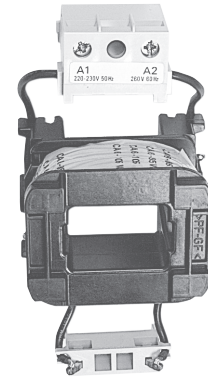

CA6 A.C. Coil (typical)

### Renewal Coils - D.C., Conventional Two-Winding Coil ❶❸

DC Control Voltages	DC Coil codes	For use with contactor...	Factory Integrated Varistor built into coil
		CA6-95 CA6-110 CA6-115, CA6-140 CA(N)6-180	
Conventional Coil		Catalog No.	
12V	12D	CA6-TG708	Yes
24V	24D	CA6-TG714	Yes
48V	48D	CA6-TG724	Yes
110V	110D	CA6-TG733	Yes
125V	125D	CA6-TG737	Yes
220V	220D	CA6-TG761	Yes
240V	~	CA6-TG750	Yes
250V	250D	CA6-TG751	Yes
Price		257.59	

❶ Other coil voltages available. Contact your Sprecher + Schuh representative for information.

❷ Not factory installed, must be ordered separately.

❸ For conventional DC coils, the pickup winding must be connected to a NC late-break auxiliary contact. (See page A149)

**Renewal Coils - A.C., “-EI” Electronic Coil ①③⑤**

AC Control Voltages		AC Coil Codes ②	For use with contactor...				'EI' Coil Suppressor Info	
			CA6-95-EI CA6-110-EI CA6-115-EI CA6-140-EI CA6-180-EI CAN6-180-EI CA6-210-EI CA6-250-EI	CA6-300-EI CAN6-300-EI	CA6-420-EI	CA6-630-EI CA6-860-EI	Factory Integrated Suppressor on Coil Circuit Board ③	Factory Installed External Suppressor Module ④
EI Coil			Catalog No.	Catalog No.	Catalog No.	Catalog No.		Catalog No.
60 Hz	50/60 Hz							
~	24V	<b>24</b>	CA6-TGE855	CA6-TGE855	~	~	No	CRV6-40
~	42-64V	<b>48</b>	CA6-TGE864	CA6-TGE864	~	~	No	CRV6-75
~	110-130V	<b>120</b>	CA6-TGE865	CA6-TGE865	CA6-THE865	~	Yes	~
~	208-277V	<b>220W</b>	CA6-TGE866	CA6-TGE866	CA6-THE866	~	Yes	④
~	380-500V	<b>460W</b>	CA6-TGE867	CA6-TGE867	CA6-THE867 ⑥	~	Yes	RC 100N ⑤
~	110-130V	<b>120</b>	~	~	~	CA6-TJE865 ⑥	Yes	~
~	200-220V	<b>208W</b>	~	~	~	CA6-TJE878	Yes	~
~	230-250V	<b>240W</b>	~	~	~	CA6-TJE879 ⑥	Yes	~
~	277V	<b>277</b>	~	~	~	CA6-TJE880	Yes	~
~	380-415V	<b>380</b>	~	~	~	CA6-TJE867	Yes	~
~	440-480V	<b>480</b>	~	~	~	CA6-TJE868	Yes	~
<b>Price</b>			<b>437.27</b>	<b>437.27</b>	<b>586.84</b>	<b>916.09</b>		<b>24.30</b>

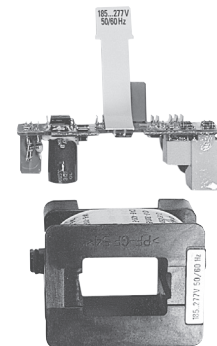

CA6 A.C. “-EI” coil (typical)

**Renewal Coils - D.C., “-EI” Electronic Coil ①③④**

DC Control Voltage		DC Coil Codes	For use with contactor...				'EI' Coil Suppressor Info	
			CA6-95-EI CA6-110-EI CA6-115-EI CA6-140-EI CA6-180-EI CAN6-180-EI CA6-210-EI CA6-250-EI	CA6-300-EI CAN6-300-EI	CA6-420-EI	CA6-630-EI CA6-860-EI	Factory Integrated Suppressor on Coil Circuit Board ③	Factory Installed External Suppressor Module ④
EI Coil			Catalog No.	Catalog No.	Catalog No.	Catalog No.		Catalog No.
24V ⑦		<b>24D</b>	CA6-TGE708	CA6-TGE708	~	~	No	CRV6-40
48-72V		<b>48D</b>	CA6-TGE779	CA6-TGE779	~	~	No	CRV6-55
110-130V		<b>120D</b>	CA6-TGE780	CA6-TGE780	CA6-THE780	~	Yes	~
200-255V		<b>220D</b>	CA6-TGE781	CA6-TGE781	CA6-THE781	~	Yes	~
110-130		<b>120</b>	~	~	~	CA6-TJE865 ⑥	Yes	~
200-255V		<b>240W</b>	~	~	~	CA6-TJE879 ⑥	Yes	~
<b>Price</b>			<b>513.10</b>	<b>513.10</b>	<b>660.58</b>	<b>916.09</b>		<b>24.30</b>

Items in grey are obsolete.

- ① Other coil voltages available. Contact your Sprecher + Schuh representative for more information.
- ② Coil Codes in bold letters and shaded indicate coils that are standard stocked items.
- ③ Factory external suppressor module provided where shown, included with replacement coil.
- ④ Factory integrated suppressor is overvoltage category III, for optional category IV, e.g. lightning protection, a CRV6-550 module can be added.
- ⑤ Special capacitor module supplied on CA6-420 only, not shown in catalog.
- ⑥ Coil is rated AC / DC.
- ⑦ Customers with 24VDC applications should strongly consider using the “EI” functionality of the CA6 (see page A148).
- ⑧ Contactor manufactured with 380-500V coils can not be interchanged with any other coils because of the circuit board built into the base of the CA6-420.



CA6 Contactors

#### Main Contact - 3 Per Set (up to CA6-420)

Main Contacts <i>(typical)</i>	For use with...	Catalog Number	Price/ Set
	CA6-95	CA6-C95	259.66
	CA6-95-EI	CA6-CE95	307.44
	CA6-110	CA6-C110	323.02
	CA6-110-EI	CA6-CE110	323.02
	CA6-115	CA6-C115	307.44
	CA6-115-EI	CA6-CE115	307.44
	CA6-140	CA6-C140	492.33
	CA6-140-EI	CA6-CE140	492.33
	CA(N)6-180	CA6-C180	586.84
	CA(N)6-180-EI	CA6-CE180	611.77
	CA6-210-EI	CA6-CE210	792.50
	CA6-250-EI	CA6-CE250	992.96
	CA(N)6-300-EI	CA6-CE300	1184.07
	CA6-420-EI	CA6-CE420	1703.40

Items in grey are obsolete and have limited availability.

#### Main Contact & Arc Chute - Complete Set (CA6-630 and CA6-860)

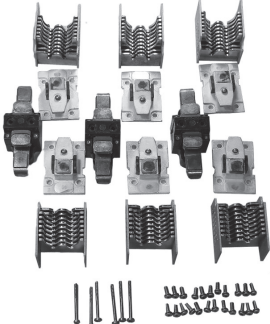
		
Complete set of three each Main Contact, Arc Chute and hardware		
For use with...	Catalog Number	Price/ Set
CA6-630-EI	CA6-CE-630 ④	3053.66
CA6-860-EI	CA6-CE-860 ④	4133.86

#### Standard Terminal Hardware (screw & washer) ①

Terminal Hardware	Fits Contactor...	Screw Type	Catalog Number	Price Each
	CA6-95 & 110	M6	CA6-HF110	28.77
	CA6-115(-EI), 140(-EI) & CA(N)6-180(-EI)	M8	CA6-HF180	43.42
	CA6-210-EI, CA6-250-EI, CA(N)6-300-EI & CA6-420-EI	M10	CA6-HF420	88.08
	CA6-630-EI to 860-EI	M12	CA6-HF860	132.95

Items in grey are obsolete and have limited availability.

#### Arc Chutes ②③

Arc Chutes <i>(typical)</i>	For use with...	Catalog Number	Price/ Set
	CA6-95	CA6-A95	128.80
	CA6-95-EI	CA6-AE95	128.80
	CA6-110	CA6-A110	173.45
	CA6-110-EI	CA6-AE110	173.45
	CA6-115	CA6-A115	166.19
	CA6-115-EI	CA6-AE115	166.19
	CA6-140	CA6-A140	194.23
	CA6-140-EI	CA6-AE140	213.96
	CA(N)6-180	CA6-A180	253.43
	CA(N)6-180-EI	CA6-AE180	253.43
	CA6-210-EI	CA6-AE210	473.63
	CA6-250-EI	CA6-AE250	564.00
	CA(N)6-300-EI	CA6-AE300	658.51
	CA6-420-EI	CA6-AE420	743.68

Items in grey are obsolete and have limited availability.

- ① Set of six (6). Priced per set.
- ② One (1) required per contactor.
- ③ CA6-...W Arc Chutes available by special order.
- ④ Kit includes Main Contacts and Arc Chute Chamber.

**Contactors Cross Reference, Series CA1 & CA6 to Series CA9 (Open Type Only) ①**

**A**

CA6 Contactors

I <sub>e</sub> [A]		Ratings for Switching AC Motors (AC2 / AC3 / AC4)										Series CA1 Obsolete	Series CA6 Obsolete	Series CA9 Equivalent
		kW (50 Hz)				UL/CSA HP (60 Hz)								
		230V	400V/ 415V	500V	690V	1 Ø		3 Ø						
115V	230V					200V	230V	460V	575V					
AC-3	AC-1	230V	400V/ 415V	500V	690V	115V	230V	200V	230V	460V	575V	Catalog Number	Catalog Number	Catalog Number
115	250	37	64/66	80	111	10	25	40	40	75	100		CA6-115	
116	160	30	55	75	55			30	40	75	100			CA9-116
						10	25	40	40	75	100	CA1-60		
140	250	45	78/82	80	111	15	30	40	50	100	125		CA6-140	
146	225	45	75	90	90			40	50	100	125			CA9-146
						15	30	50	50	100	125	CA1-100		
180	250	57	101/105	98	135	~	40	50	60	150	150		CA6-180	
190	275	55	90	90	132			50	60	125	150			CA9-190
						~	~	60	60	150	150	CA1-150		
205	350	55	110	110	160			60	75	150	200			CA9-205
210	350	67	118/122	147	205	~	50	60	75	150	200		CA6-210	
						~	~	75	100	200	250	CA1-250		
250	350	80	140/145	177	250	~	~	75	100	200	250		CA6-250	
265	400	75	132	160	200			75	100	200	250			CA9-265
300	450	97	170/176	213	293	~	~	100	125	250	300		CA6-300	
305	500	90	160	200	250			100	125	250	300			CA9-305
						~	~	150	150	350	400	CA1-480		
400	600	110	200/220	250	315			125	150	350	400			CA9-400
420	500	135	238/250	298	424	~	~	150	175	350	400		CA6-420	
460	700	132	250	315	355			150	200	400	500			CA9-460
580	800	160	315/355	400	500			200	250	500	600			CA9-580
630	800	200	355	450	500	~	~	200	250	500	600		CA6-630	
750	1050	220	400/425	520	600			250	300	600	700			CA9-750
860	1000	250	500	560	~	~	~	250	300	600	700		CA6-860	
860	1350	257	475/500	560	800			~	400	800	1000			CA9-860



CA1-10  
Contactor



CA6-140-EI contactor

① Available auxiliary contacts may vary. See selection pages for more information.

**Technical Information**

	CA6-115(-EI)	CA6-140(-EI)	CA6-180(-EI)	CA6-210-EI	CA6-250-EI	CA6-300-EI	CA6-420-EI	CA6-630-EI	CA6-860-EI
<b>Rated Insulation Voltage <math>U_i</math></b>									
IEC, AS, BS, SEV, VDE 0660	[V]				1000V				
UL; CSA	[V]				600V				
<b>Rated Voltage <math>U_{mp}</math></b>	(kV)				12kV				
<b>Rated Voltage <math>U_e</math> - Main Contacts</b>									
AC 50/60Hz	[V]				230, 240, 400, 415, 500, 690, 1000V				
DC	[V]				24, 48, 110, 220, 440V				
<b>Operating Frequency for AC Loads</b>	[Hz]				50/60Hz				

**Switching Motor Loads**

**Standard IEC Ratings**

		230V	240V	400V	415V	500V	690V	1000V	230V	240V	400V	415V	500V	600V	1000V	
<b>AC-2, AC-3</b>		[A]	[A]	[A]	[A]	[A]	[A]	[A]	[kW]	[kW]	[kW]	[kW]	[kW]	[kW]	[kW]	
DOL & Reversing		115	140	180	210	250	300	420	630	860	115	140	180	210	250	
50Hz		115	140	180	210	250	300	420	630	860	115	140	180	210	250	
		115(130)①	140(155)①	180(189)③	210(227)①	250(258)①	300(315)①	420	630	860	115	140(155)②	180(180)①	210	250	
		115	115/140②	140(180)①	210	250	300	420	630	753	115	115/140②	140(180)①	210	250	
		46	55	65	80	95	115	160	~	~	46	55	65	80	95	
		37	45	57	67	80	97	135	200	250	37	45	57	67	80	
		38	47	60	70	83	101	141	200	250	38	47	60	70	83	
		64	78	101	118	140	170	238	355	500	64	78	101	118	140	
		66(75)①	82(90)①	105(110)①	122(132)①	145(150)①	176(185)①	250	355	500	66(75)①	82(90)①	105(110)①	122(132)①	145(150)①	
		80	80(98)②	98(126)①	147	177	213	298	450	560	80	80(98)②	98(126)①	147	177	
		111	111/135②	135(176)①	205	250	293	424	500	~	111	111/135②	135(176)①	205	250	
		63	75	90	110	132	160	225	~	~	63	75	90	110	132	
<b>UL/CSA</b>		[A]	[A]	~	~	~	~	~	~	~	115V	135V	~	~	~	
DOL & Reversing 1Ø		110	136	176	216	~	~	~	~	~	230V	230V	230V	230V	230V	
60Hz		10	15	~	~	~	~	~	~	~	115 V	15	~	~	~	
		25	30	40	50	~	~	~	~	~	230 V	30	40	50	~	
		120	120	150	177	221	285	414	552	692	200V	120	120	150	177	221
		104	130	154	192	248	312	420	602	720	230 V	104	130	154	192	248
		96	124	180	180	240	302	414	590	702	460 V	96	124	180	180	240
	3Ø	99	125	144	192	242	289	382	562	651	575 V	99	125	144	192	242
		40	40	50	60	75	100	150	200	250	200 V	40	40	50	60	75
		40	50	60	75	100	125	175	250	300	230 V	40	50	60	75	100
		75	100	150	150	200	250	350	500	600	460 V	75	100	150	150	200
		100	125	150	200	250	300	400	600	700	575 V	100	125	150	200	250
<b>AC4 (200,000 Op. Cycles)</b>		[A]	[A]	[A]	[A]	[A]	[A]	[A]	~	~	230V	53	60	67	85	105
50Hz		53	60	67	85	105	140	170	~	~	240V	53	60	67	85	105
		53	60	67	85	105	140	170	~	~	400/415V	53	60	67	85	105
		53	60	67	85	105	140	170	~	~	500V	53	60	67	85	105
		53	60	67	85	105	140	170	~	~	690V	53	60	67	85	105
		25	37	43	60	72	85	105	~	~	1000V	25	37	43	60	72
		15	17	20	25	32	45	55	~	~	230V	15	17	20	25	32
		15	18.5	22	25	32	45	55	~	~	240V	15	18.5	22	25	32
		25	32	37	45 / 50	55	75 / 80	90 / 100	~	~	400/415V	25	32	37	45 / 50	55
		32	40	45	55	75	100	110	~	~	500V	32	40	45	55	75
		45	55	63	80	100	132	160	~	~	690V	45	55	63	80	100
		30	50	55	80	100	110	150	~	~	1000V	30	50	55	80	100
<b>Max. Operating Rate</b>	[ops/hr]	120	120	100	120	100	70	70	~	~						

① Values in ( ) represent ratings for AC-2 & AC-3 and result in reduced lifespan of 25%. Use 400V values for full life span.

② Second number is rating for the "-EI" model.

**Electrical Data**

			CA6-115(-EI)	CA6-140(-EI)	CA6-180(-EI)	CA6-210-EI	CA6-250-EI	CA6-300-EI	CA6-420-EI	CA6-630-EI	CA6-860-EI
<b>Switching Motor Loads (continued)</b>											
<b>Wye-Delta (Star Delta)</b>											
50Hz	230V	[A]	199	242	312	364	433	520	727	~	~
	240V	[A]	199	242	312	364	433	520	727	~	~
	400V	[A]	199	242	312	364	433	520	727	~	~
	415V	[A]	199(225)	242(268)①	312(332)	364(393)①	433(447)①	520(546)①	727	~	~
	500V	[A]	199	199 / 242②	312	364	433	520	727	~	~
	690V	[A]	199	199 / 242②	312	364	433	520	727	~	~
	1000V	[A]	80	95	113	139	165	200	277	~	~
	230V	[kW]	63	75	90	110	132	160	220	~	~
	240V	[kW]	66	80	100	125	150	160	250	~	~
	400V	[kW]	110	132	160	200	250	300	425	~	~
	415V	[kW]	114(132)①	132(160)①	160	220	250	315(335)①	425①	~	~
	500V	[kW]	132	132 / 160②	200	250	315	375	530	~	~
	690V	[kW]	192	200 / 220②	300	355	425	530	750	~	~
	1000V	[kW]	100	132	160	200	220	280	400	~	~
60 Hz	200V	[HP]	60	60	75	100	125	175	250	~	~
	230V	[HP]	60	75	100	125	175	200	250	~	~
	460V	[HP]	125	175	200	250	350	450	600	~	~
	575V	[HP]	150	200	250	300	450	500	650	~	~
<b>UL/GSA Elevator Duty</b>											
	200V	[A]	78	92	120	150	150	177	221	~	~
	230V	[A]	80	104	130	130	154	192	248	~	~
	460V	[A]	77	96	124	156	180	180	240	~	~
	575V	[A]	77	77	99	125	144	192	242	~	~
	200V	[HP]	25	30	40	50	50	60	75	~	~
	230V	[HP]	30	40	50	50	60	75	100	~	~
	460V	[HP]	60	75	100	125	150	150	200	~	~
	575V	[HP]	75	75	100	125	150	200	250	~	~
<b>AC-1 Load, 3∅ Switching</b>											
Ambient Temperature 40°C	$I_{th}$	[A]	250	250	250	350	350	450	540	800	1000
	230V	[kW]	100	100	100	139	139	179	199	319	398
	240V	[kW]	104	104	104	145	145	187	208	333	416
	400V	[kW]	173	173	173	242	242	312	346	554	693
	415V	[kW]	180	180	180	252	252	323	359	575	719
	500V	[kW]	217	217	217	303	303	390	433	693	866
	690V	[kW]	299	299	299	418	418	538	598	956	1195
	1000V	[kW]	433	433	433	606	606	779	866	~	~
Ambient Temperature 60°C	$I_{th}$	[A]	210	210	210	300	300	380	425	~	~
	230V	[kW]	84	84	84	120	120	151	169	~	~
	240V	[kW]	87	87	87	125	125	158	177	~	~
	400V	[kW]	145	145	145	208	208	263	294	~	~
	415V	[kW]	151	151	151	216	216	273	305	~	~
	500V	[kW]	182	182	182	260	260	329	368	~	~
	690V	[kW]	251	251	251	359	359	454	508	~	~
	1000V	[kW]	364	364	364	520	520	658	736	~	~

① Values in ( ) represent ratings for AC3 & AC4 and result in reduced lifespan of 25%.

Use 400V values for full life span.

② Rating CA6-140 / CA6-140-EI.

# A

CA6 Contactors

### Electrical Data

			CA6-115(-EI)	CA6-140(-EI)	CA6-180(-EI)	CA6-210-EI	CA6-250-EI	CA6-300-EI	CA6-420-EI	CA6-630-EI	CA6-860-EI	
<b>Continuous Current (UL/CSA)</b>												
General Purpose Rating (40°C)	Open	[A]	250	250	250	350	350	420	500	760	1000	
	Enclosed	[A]	220	220	220	300	300	340	420	630	860	
<b>Lighting Loads</b>												
Elect. Dischrg. Lamps-AC-5a, single compensated	Open	[A]	144	225	225	315	315	405	450	~	~	
	Enclosed	[A]	122	189	189	270	270	342	383	~	~	
Incandescent Lamps - AC-5b		[A]	120	140	170	210	250	300	420	~	~	
<b>Switching power transformers AC-6a</b>												
<b>Inrush</b>												
Rated transformer current, $P_e$												
n=30	240VAC	[A]	60	70	85	105	125	150	210	~	~	
	230 VAC	[kVA]	24	28	34	42	50	60	84	~	~	
	240 VAC	[kVA]	26	29	35	44	52	62	87	~	~	
	400 VAC	[kVA]	42	48	59	73	87	104	145	~	~	
	415 VAC	[kVA]	43	50	61	75	90	108	151	~	~	
	500 VAC	[kVA]	52	61	74	91	108	130	182	~	~	
	690 VAC	[kVA]	72	84	102	125	149	179	251	~	~	
	1000 VAC	[kVA]	80	121	147	182	217	260	364	~	~	
	n = 20	690 VAC	[A]	90	105	128	158	188	225	315	~	~
	n = 15	690 VAC	[A]	120	140	170	210	250	300	420	~	~
60Hz Peak inrush/peak rated transformer												
n = 30		[A]	60	70	85	105	125	150	210	~	~	
	200V	[kVA]	20.8	24.2	29.4	36.4	43.3	52.0	72.7	~	~	
	208V	[kVA]	21.6	25.2	30.6	37.8	45.0	54.0	75.7	~	~	
	240V	[kVA]	24.9	29.1	35.3	43.6	52.0	62.4	87.3	~	~	
	480V	[kVA]	49.9	58.2	70.7	87.3	104	125	175	~	~	
	600V	[kVA]	62.4	72.7	88.3	109	130	156	218	~	~	
	660V	[kVA]	68.6	80.0	97.2	120	143	171	240	~	~	
60Hz Peak inrush/peak rated transformer												
n = 20		[A]	90	105	128	158	188	225	315	~	~	
	200V	[kVA]	31.2	36.4	44.3	54.7	65.1	77.9	109	~	~	
	208V	[kVA]	32.4	37.8	46.1	56.9	67.7	81.1	113	~	~	
	240V	[kVA]	37.4	43.6	53.2	65.7	78.2	93.5	131	~	~	
	480V	[kVA]	74.8	87.3	106	131	156	187	262	~	~	
	600V	[kVA]	93.5	109	133	164	195	234	327	~	~	
	660V	[kVA]	103	120	146	181	215	257	360	~	~	
60Hz Peak inrush/peak rated transformer												
n = 15		[A]	120	140	170	210	250	300	420	~	~	
	200V	[kVA]	41.6	48.5	58.9	72.7	86.6	104	145	~	~	
	208V	[kVA]	43.2	50.4	61.2	75.7	90.1	108	151	~	~	
	240V	[kVA]	49.9	58.2	70.7	87.3	104	125	175	~	~	
	480V	[kVA]	99.8	116	141	175	208	249	349	~	~	
	600V	[kVA]	125	145	177	218	260	312	436	~	~	
	660V	[kVA]	137	160	194	240	286	343	480	~	~	

**Electrical Data**

			CA6-115(-EI)	CA6-140(-EI)	CA6-180(-EI)	CA6-210-EI	CA6-250-EI	CA6-300-EI	CA6-420-EI	CA6-630(EI)	CA6-860-EI
<b>DC Ratings</b>											
<b>DC-1 Rating at 60°C</b>											
1 Pole	Non-inductive or slightly inductive loads, resistive furnaces	24VDC	[A] 135	210	210	300	300	380	425	~	~
		48VDC	[A] 135	210	210	300	300	380	425	~	~
		110VDC	[A] 135	210	210	300	300	380	425	~	~
		220VDC	[A] 3	3.3	3.3	4.9	4.9	4.9	5.2	~	~
		440VDC	[A] 0.6	0.75	0.75	1	1	1	1.2	~	~
2 Poles in Series		24VDC	[A] 135	210	210	300	300	380	425	~	~
		48VDC	[A] 135	210	210	300	300	380	425	~	~
		110VDC	[A] 135	210	210	300	300	380	425	~	~
		220VDC	[A] 135	210	210	300	300	380	425	~	~
		440VDC	[A] 3	3.3	3.3	4.9	4.9	4.9	5.2	~	~
3 Poles in Series ❶		24VDC	[A] 135	210	210	300	300	380	425	~	~
		48VDC	[A] 135	210	210	300	300	380	425	~	~
		110VDC	[A] 135	210	210	300	300	380	425	~	~
		220VDC	[A] 135	210	210	300	300	380	425	~	~
		440VDC	[A] 11	11	11	14	14	14	15	~	~
<b>DC-3 Rating at 60°C</b>											
Shunt wound motors - Starting, reverse current breaking, reversing, stepping		24VDC	[A] 135	210	210	300	300	380	425	~	~
		48VDC	[A] 135	210	210	300	300	380	425	~	~
		110VDC	[A] 135	210	210	300	300	380	425	~	~
		220VDC	[A] 135	210	210	300	300	380	425	~	~
3 Poles in Series ❶	440VDC	[A] 3	3.5	3.5	4.1	4.1	4.1	5.8	~	~	
<b>DC-5 Rating at 60°C</b>											
Series wound motors - Starting, reverse current breaking, reversing, stepping		24VDC	[A] 135	210	210	300	300	380	425	~	~
		48VDC	[A] 135	210	210	300	300	380	425	~	~
		110VDC	[A] 135	210	210	300	300	380	425	~	~
		220VDC	[A] 135	210	210	300	300	380	425	~	~
3 Poles in Series ❶	440VDC	[A] 1.2	2.1	2.1	2.4	2.4	2.4	3.0	~	~	

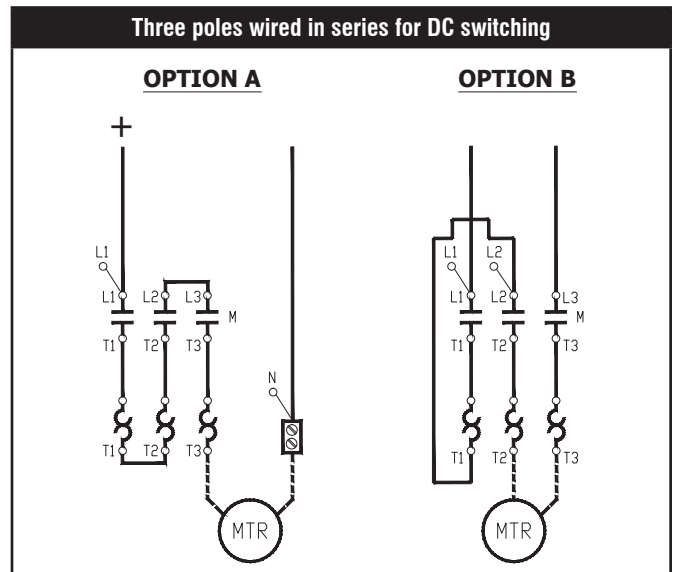

❶ See diagram to right for three poles wired in series for DC switching

**Electrical Data**

			CA6-115(-EI)	CA6-140(-EI)	CA6-180(-EI)	CA6-210(-EI)	CA6-250(-EI)	CA6-300(-EI)	CA6-420(-EI)	CA6-630(-EI)	CA6-860(-EI)
<b>Capacitor Ratings AC-6b</b>											
<b>Capacitor Switching - 50Hz</b>											
Single Capacitor - 40°C	230 V	[kVar]	45	70	70	98	98	125	139	~	~
	240 V	[kVar]	47	73	73	102	102	131	145	~	~
	400 V	[kVar]	78	121	121	170	170	218	242	~	~
	415 V	[kVar]	81	126	126	176	176	226	252	~	~
	500 V	[kVar]	97	152	152	212	212	273	303	~	~
	690V	[kVar]	134	209	209	293	293	376	418	~	~
	1000 V	[kVar]	194	303	303	424	424	546	606	~	~
Single Capacitor - 60°C	230 V	[kVar]	38	59	59	84	84	106	119	~	~
	240 V	[kVar]	39	61	61	87	87	111	124	~	~
	400 V	[kVar]	65	102	102	145	145	184	206	~	~
	415 V	[kVar]	68	106	106	151	151	191	214	~	~
	500 V	[kVar]	82	127	127	182	182	230	258	~	~
	690V	[kVar]	113	176	176	251	251	318	356	~	~
	1000 V	[kVar]	164	255	255	364	364	461	515	~	~
Capacitor Bank- 40°C	230 V	[kVar]	45	70	70	98	98	125	139	~	~
	240 V	[kVar]	47	73	73	102	102	131	145	~	~
	400 V	[kVar]	56	76	111	170	170	218	242	~	~
	415 V	[kVar]	56	76	112	170	176	226	252	~	~
	500 V	[kVar]	56	76	113	172	212	273	303	~	~
	690V	[kVar]	57	78	114	174	247	356	418	~	~
	1000 V	[kVar]	58	79	116	177	251	361	606	~	~
Capacitor Bank- 60°C	230 V	[kVar]	38	59	59	84	84	106	119	~	~
	240 V	[kVar]	39	61	61	87	87	111	124	~	~
	400 V	[kVar]	56	76	102	145	145	184	206	~	~
	415 V	[kVar]	56	76	106	151	151	191	214	~	~
	500 V	[kVar]	56	76	113	172	182	230	258	~	~
	690V	[kVar]	57	78	114	174	247	318	356	~	~
	1000 V	[kVar]	58	79	116	177	251	361	515	~	~
<b>Capacitor Switching - 60Hz</b>											
Single Capacitor - 40°C	200 V	[kVar]	39	61	61	85	85	109	121	~	~
	230 V	[kVar]	45	70	70	98	98	125	133	~	~
	460 V	[kVar]	89	139	139	195	195	251	279	~	~
	600V	[kVar]	116	182	182	255	255	327	364	~	~
Capacitor Bank- 40°C	200 V	[kVar]	39	61	61	85	85	109	121	~	~
	230 V	[kVar]	45	70	70	98	98	125	139	~	~
	460 V	[kVar]	56	76	112	171	195	251	279	~	~
	600V	[kVar]	57	77	114	173	246	327	364	~	~

**Electrical Data**

		CA6-115(-EI)	CA6-140(-EI)	CA6-180(-EI)	CA6-210-EI	CA6-250-EI	CA6-300-EI	CA6-420-EI	CA6-630-EI	CA6-860-EI	
<b>Short-Circuit Coordination</b>											
<b>Contactors without Motor Protection Relays</b>											
<b>DIn Fuses - gG, gL</b>											
Available Fault Current	[A]	100 KA	100 KA	100 KA	100 KA	100 KA	100 KA	100 KA	~	~	
Type "1"	[A]	250	315	315(355)	500	500	630	630	①	①	
Type "2" (380/400/415/690V) ④	[A]	200	250	250(315)	400	400	500	500			
Type "2" (1000V) ④	[A]	200	250	250(315)	400	400	500	500			
<b>cUL Short-Circuit Ratings</b>											
<b>Class K1, RK1, K5, and RK5 Fuses (L Fuses)</b>											
Available Fault Current	[A]	10 KA	10 KA	10 KA	10 KA	18 KA	18 KA	18 KA	30 KA	42 KA	
cUL Max. Rating (600V) ⑤ Type 1	[A]	250	350	450	500	L-700	L-700	L-1000	L-2000	L-2500	
<b>Class J CSA &amp; HRCI-J Fuses ②</b>											
Available Fault Current	[A]	100 KA	100 KA	100 KA	100 KA	100 KA	100 KA	100 KA	~	~	
cUL Max. Rating (600V) ⑤ Type 2	[A]	200	250	300	400	400	500	600	~	~	
<b>Circuit Breaker, inverse time ⑤</b>											
Available Fault Current	[A]	10 KA	10 KA	10 KA	10 KA	18 KA	18 KA	18 KA	30 KA	42 KA	
cUL Max. Rating (600V) ⑤ Type 1	[A]	150	200	250	300	350	400	500	1200	1200	
<b>Short Time Current Withstand Ratings</b>											
$I_{cw}$ 60° C	1 S	[A]	1800	1800(2550) ②	2550	3405	3870	4725	6376	①	①
	4 S	[A]	1500	1800(1970) ②	1970	3150	3870	4100	6376		
	10 S	[A]	1040	1240(1360) ②	1480	2360	2520	2840	4700	6300	7000
	15 S	[A]	860	860 (1130) ②	1130	2000	2110	2270	3460		
	60 S	[A]	650	650 (850) ②	850	1215	1300	1500	1880	①	①
	240 S	[A]	340	340 (600) ②	600	705	750	840	1280		
900 S	[A]	240	250 (440) ②	440	460	500	590	840			
Off Time Between Operations	[Min.]	20	20	20	30	30	30	30			
<b>Resistance and Watt Loss <math>I_e</math> AC3</b>											
Resistance per power pole	[mW]	0.4	0.42	0.42	0.22	0.22	0.18	0.15	0.19	0.14	
Watt Loss - 3 power poles	[W]	14.5	24.6	40.8	29.4	41.7	48.6	79.4	226.2	310.6	
Coil and 3 power poles (@ $I_{eAC3}$ )	AC	[W]	24.5(20.5) ②	34.6(30.6) ②	50.8(46.8) ②	35.4	47.7	54.6	86.5	256.2	340.6
	DC	[W]	22.5(20.5) ②	32.6(30.6) ②	48.8(46.8) ②	35.4	47.7	54.6	86.5	256.2	340.6

- ① Under test. Contact your Sprecher + Schuh representative.
- ② Values in parentheses ( ) are for the -EI- contactor.
- ③ UL Listed Combination. (UL File E41850) Per UL508A, NEC409 and CSA 22.2 No.14 for contactor and fuses or circuit breaker only.
- ④ Per IEC 60947-1 for contactor and fuses only.
- ⑤ When used as a Branch Circuit Protection device, NEC 430-152 defines the maximum rating of an Inverse-time circuit breaker to be sized at 250% of the motor nameplate FLA for most applications.



**Short Circuit Ratings**

High Fault Short Circuit Ratings per UL508 and CSA 22.2 No.14

CEP7 Second Generation Cat. No.	Contactor Catalog No.	Max. starter FLC (A)	Fuse Ratings			UL Listed Circuit Breaker Ratings ①			
			Max. avail- able fault current (kA)	Max. voltage (V)	UL Class J and CSA HRCI-J fuse (A)	Short Circuit Rating (kA)	Max. Voltage (V)	Max. CB rating (A)	
CEP7	EEHF	CA6-115 CAN6-115	100	600	200	65 25	480 600	250	
		CA6-140			250				
	EEJF	CA6-180 CAN6-180	180	100	600	300	65 25	480 600	250
		EEJG	CA6-210	100	600	400	65 30	480 600	400
	CA6-250		400						
	CA6-300 CAN6-300		500						
	EEKG	CA6-210	100	600	400	65 30	480 600	400	
		CA6-250			400				
		CA6-300 CAN6-300			500				
	EELG	CA6-420	420	100	600	600	42 25	480 600	600

① Various Mfg. of UL Listed Circuit Breakers may be used.

**Mechanical Data**

			CA6-115	CA6-115-EI	CA6-140(-EI)	CA6-180(-EI)	CA6-210-EI	CA6-250-EI	CA6-300-EI	CA6-420-EI	CA6-630-EI	CA6-860-EI
<b>Service Life</b>	Mechanical	AC	[Mil.]	10	10	10	10	10	10	10	2	2
		DC	[Mil.]	10	10	10	10	10	10	10	2	2
	Electrical	AC-3 (400V)	[Mil.]	1	1	1	1	1	1	1	R/F	R/F
<b>Shipping Weights</b>												
AC - CA6		[kg]	3.3	3.8	3.3 (3.8)	3.3 (3.8)	7.5	7.5	7.5	7.5	28.6	28.6
		[Lbs]	7.3	8.38	7.3 (8.4)	7.3 (8.4)	16.5	16.5	16.5	16.5	63	63
DC - CA6		[kg]	3.3	3.8	3.3 (3.8)	3.3 (3.8)	7.5	7.5	7.5	7.5	28.6	28.6
		[Lbs]	7.28	8.38	7.3 (8.4)	7.3 (8.4)	16.5	16.5	16.5	16.5	63	63

**Terminations - Power**

Type

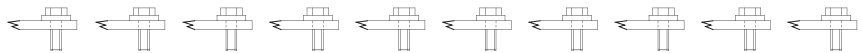

**Direct Connection**

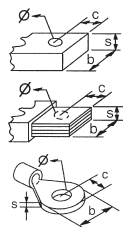

			Hexagonal Bolt	
b max.	[mm]	25	30	52
c max.	[mm]	12.5	15	22
s max.	[mm]	5	6	2 x 8
Ø min.	[mm]	8.3	10.5	13
Recommended Torque	[Nm]	22	43	68
	[Lb-in]	195	380	600

**With Main Terminal Set (CA6-HB...)**

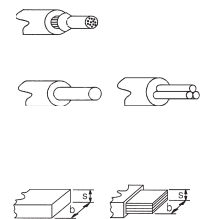

sm. opening	[mm <sup>2</sup> ]	16...35	25...185	~
lg. opening	[mm <sup>2</sup> ]	16...95	25...185	~
sm. opening	[mm <sup>2</sup> ]	16...50	25...240	~
lg. opening	[mm <sup>2</sup> ]	16...120	25...240	~
b max.	[mm]	20	25	~
s. sm. opening	[mm]	3...9	6...20	~
s. lg. opening	[mm]	3...14	6...20	~
Recommended Torque	[Nm]	14	25	~
Wire Size per UL/CSA	sm. opening [AWG]	#6...1 / 0	#4...600MCM	~
	lg. opening [AWG]	#6...250MCM	#4...600MCM	~
Recommended Torque	[Lb-in]	124	220	~

Minimum 25mm<sup>2</sup> (#4 AWG) -95mm<sup>2</sup> (250mcm) with sleeve per DIN 46228.

**Mechanical Data** (continued)

		CA6-115(-EI)	CA6-140(-EI)	CA6-180(-EI)	CA6-210(-EI)	CA6-250(-EI)	CA6-300(-EI)	CA6-420(-EI)	CA6-630(-EI)	CA6-860(-EI)
<b>With Screw-type Lugs - Copper Clad (CA6-L...)</b>										
Screw-type lugs accept round conductors only										
<b>CA6-L180</b>	[AWG]	#6...300 MCM			~			~	~	~
Recommended Torque	[Lb-in]	88...106			~			~	~	~
<b>CA6-L420</b>	[AWG]	~			2x #4...350 MCM			~	~	~
Recommended Torque	[Lb-in]	~			375			~	~	~
<b>CA6-L630</b>	[AWG]	~			~			2 x 2 / 0... 500 MCM	~	~
Recommended Torque	[Lb-in]	~			~			400	~	~
<b>CA6-L860</b>	[AWG]	~			~			~	4 x 2 / 0... 500 MCM	~
Recommended Torque	[Lb-in]	~			~			~	400	~

**Terminations - Control**

Description	 Combination Screw Head: Cross, Slotted, Pozidrive									
<b>Coils</b>										
Wires	1 or 2	[mm <sup>2</sup> ]				1...2.5				
		[AWG]				16...12				
Torque Requirement		[Nm]				1...1.5				
		[Lb-in]				8.9...13				
<b>Control Modules</b>										
Wires	1	[mm <sup>2</sup> ]				1...4				
		[AWG]				16...12				
<b>Degree of Protection - contactor</b>	IP00 per IEC 60529 and DIN 40 050									
<b>Type of Protection - with accessories</b>										
Single contactor cover	IP1X per IEC 60529 and DIN 40 050									
With main terminal set	IP2X per IEC 60529 and DIN 40 050									
<b>Protection against accidental contact</b>	Finger and back-of-hand proof according to VDE 0106, Part 100									

**Coil Data**

			CA6-115...180	CA6-115-EI...300-EI	CA6-420-EI	CA6-630-EI...860-EI
			Conventional Coil	"EI" Coil	"EI" Coil	"EI" Coil
<b>Voltage Range</b>	AC: 50Hz, 60Hz, 50/60 Hz	Pickup [x Us]	0.85...1.1	0.85 Us min...1.1 Us max	0.85 Us min...1.1 Us max	0.80 Us min...1.1 Us max
		Dropout [x Us]	0.3...0.6	0.3 Us min...0.5 Us max	0.3 Us min...0.5 Us max	0.1 Us min...0.8 Us max
DC		Pickup [x Us]	0.85...1.1	0.85 Us min...1.1 Us max	0.85 Us min...1.1 Us max	0.85 Us min...1.1 Us max
		Dropout [x Us]	0.30...0.6	0.3 Us min...0.5 Us max	0.3 Us min...0.5 Us max	0.1 Us min...0.8 Us max
<b>Coil Consumption</b>						
AC: 50Hz, 60Hz, 50/60 Hz	Pickup	[VA/W]	650 / 310	380 / 240 ②	490 / 270 ②	1915 / 1720
	Hold-in	[VA/W]	50 / 10	13 / 6	18 / 7	33 / 30
DC	Pickup	[W]	540 ①②	265 ①③	340 ①③	1980 ①③
	Hold-in	[W]	8	6	7	30
EI (B1-B2 24VDC Interface)		[VA/W]	~	15 ma	15 ma	15 ma
<b>Operating Times</b>						
AC: 50Hz, 60Hz, 50/60 Hz	Pickup	[ms]	20...47	20...45	20...45	60...100
	Dropout	[ms]	6...12	25...110	25...110	70...145
with RC Suppressor	Dropout	[ms]	9...18	~	~	~
DC	Pickup	[ms]	27...47	25...50	25...50	60...100
	with Integ. Suppression	Dropout	[ms]	12...20	35...110	35...110
<b>Insulation Class</b>				Class "B" according to VDE 0660, Table 22		

**CA6-EI Application Notes for 24 volt AC/DC Electronic Coils**

The CA6-EI 24 VAC or 24 VDC electronic coils are sensitive to voltage drops. These notes are provided to assist customers in control wiring methods and the selection of a power supply.

< 10ms	$I_{peak} = 25$ amps	Start-up peak
< 100ms	$I_{mean} = 11$ amps	Pull-in values
> 100ms	$I_{hold} = 0.5$ amps	Average Hold-in values

**Circuit operation**

- While the electronic coil is switching on, the power supply must deliver a peak of 25 amps. This period will not exceed 10ms.
- During the contactor closing period, the pull-in current of the coil drops to 11 amps. This period will not exceed 100ms.
- After approximately 80ms the demand of the electronic coil will be reduced to the holding value; which has an average of 0.5 amps.

**Power supply selection**

- Use peak value ( $I_{peak}$ ) for the selection of the power supply.
- A regulated power supply is preferred.
- If an unregulated power supply is utilized then the no load value of the power supply must be less than 28 volts. Additional attention must be given to decrease the control wire resistance because unregulated power supplies have a high ripple voltage.

**Control Circuit Wiring**

To minimize wire resistance see the following:

- The wire gauge (cross-section) must be sufficient to allow a wire resistance of less than 150 milli-ohms for a regulated power supply and 100 milli-ohms for an unregulated power supply. For unregulated power supplies, 16 AWG can be used for runs up to 25 feet (longer for regulated power supply). Consult Sprecher + Schuh for additional information if longer runs are required.
- Stranded wire should be fitted with ferrules.
- Terminations should be tightened within the recommended torque values.
- If multiple CA6-EI contactors are used in the control circuit, the electronic coil terminations should be fed directly from the power supply (home runs). Do NOT parallel (jumper) multiple coil terminations. Switching of the home runs must be accomplished through separate (individual) contacts of a control relay or control device.

**A Recommendation**

A CA6 contactor used in the "EI" mode removes the burden of the coil from the 24 VDC power supply. The integrated electronic interface allows line voltage, or at least a higher AC voltage (i.e., 120V), to be applied to coil terminals A1 – A2, while the 24 VDC low level milli-ampere signal switches the B1 – B2 interface. The "EI" mode (method) has significant advantages over direct coil switching at 24 VDC. See the description of operation on the next page.

① Customers with 24VDC applications should strongly consider using the "EI" functionality of the CA6 (see pages A148-A149).

② Conventional DC coils are Two-Winding Coils. See page A149.

③ Electronic coil drives are designed to minimize power requirements, but this control may exhibit higher inrush (540W, <10ms) when energizing. This must be taken into account for the proper sizing of supply devices, all-or-nothing relays, and cross-sections of coil supply lines.

**A** CA6 Electronic Coils (CA6-115-EI...CA6-860-EI)

CA6 Contactors

CA6-EI contactors are supplied with an electronically controlled mechanism, which has an integrated electronic interface that consists of the following main parts:

- The coil bobbin rated for the control voltage.
- A printed circuit board with components for control and interface functions which is matched to the coil and rated for the control voltage.
- An interconnecting printed circuit board with coil terminals, which is located in the contactor base.
- R/C transient surge suppressors which are installed on the printed circuit board.

The CA6-EI coil bobbin and printed circuit board are a matched set; therefore, both must be changed when replacing the coil or changing out the coil to a different voltage. All replacement coils include both the coil bobbin and printed circuit board.

**Commissioning**

The CA6-EI contactor is operated in either the “E” mode (normal operation) or the “EI” mode (electronic interface operation) and is programmed by an orange “jumper” located on the bottom side of the contactor (opposite the coil terminals). This orange jumper is directly underneath main terminal T2 and is exposed by removing the small plastic cover that shields the mating space for the CRC/CRV protec-

tion element.

**Electronic Operation – “E” Mode**

For the “E” mode (factory default setting), the contactor is connected and controlled using terminals A1 & A2 in the same manner as a traditional contactor with an electromechanical coil mechanism. The contactor is programmed from the factory in the “E” mode by means of the orange jumper in the position as shown in Detail A. The “E” mode (or electronic mode) provides electronic control of the coil mechanism, but does not allow coil energizing from a low level signal source such as a PLC.

**Electronic Interface Operation – “EI” Mode**

For the “EI” mode, or optional electronic interface setting, the contactor can be switched from a PLC or other low-level signal source (13...30.2 VDC) without the need for an interposing relay. The contactor is programmed for the “EI” mode by moving the orange jumper to the position as shown in Detail B.

In the “EI” mode, the control voltage (VAC or VDC) must be permanently switched on to terminals A1 & A2 while in operation. The control signal from the PLC or other low-level signal source must be applied to terminals B1 & B2 (orange terminals) of the electronic interface in order to energize the contactor. The current burden of the interface is 15mA maximum.

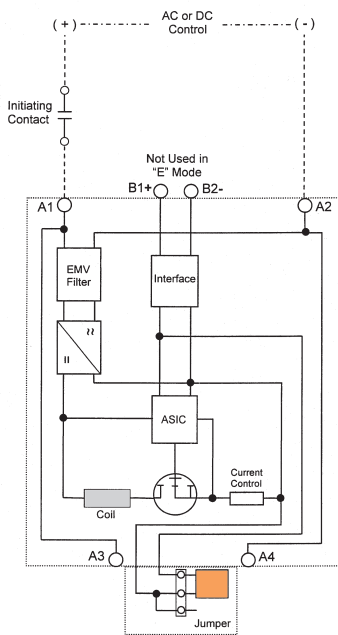

“E” Mode or Normal Operation Detail-A

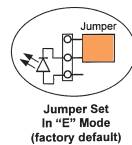

Jumper Set In “E” Mode (factory default)

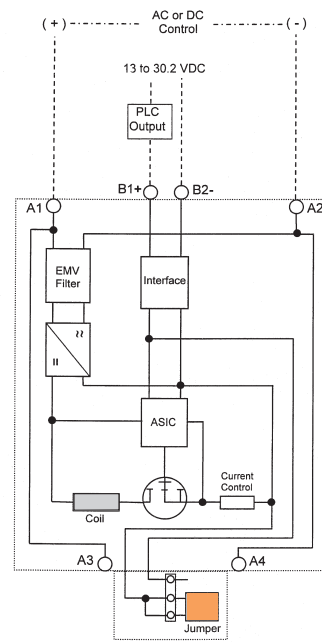

“EI” Mode or Interface Operation Detail-B

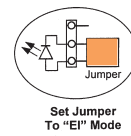

Set Jumper To “EI” Mode

**CA6 Conventional DC Coil (CA6-115...CA6-180)**

**Conventional 3-lead DC Coil**

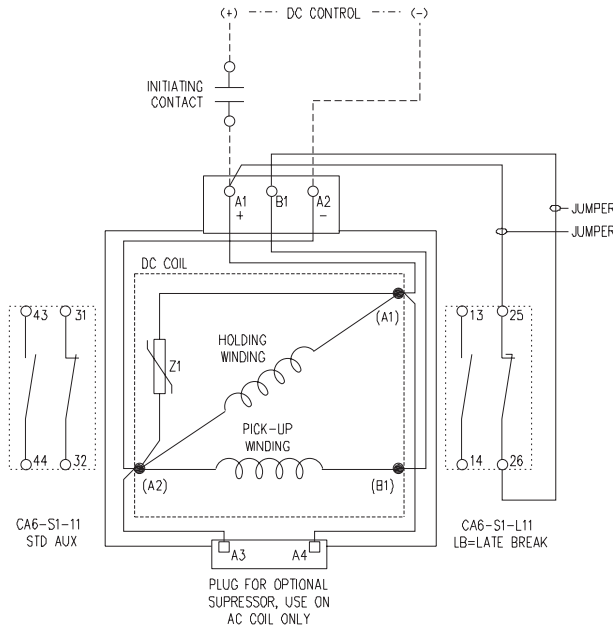

**Notes**

- 1) The CA6 conventional DC coil has dual windings with three leads brought out. One winding is the "pick-up" winding and the other is the "holding" winding. The coil also has a built-in voltage limiting varistor (Z1).
- 2) The pick-up winding has low resistance while the holding winding has a higher resistance.
- 3) When the control circuit is energized, the contactor "pulls-in" through the lower resistance pick-up winding and the NC late break auxiliary contact. After the contactor seals in, the late break contact opens and the contactor is held in through the holding winding.
- 4) The pick-up winding is not designed for continuous operation and must be disconnected by the "late break" contact immediately after the contactor pulls-in.





A

CA6 Contactors

## Environmental and General Specifications

	CA6-115(-EI)	CA6-140(-EI)	CA6-180(-EI)	CA6-210(-EI)	CA6-250(-EI)	CA6-300(-EI)	CA6-420(-EI)	CA6-630(-EI)	CA6-860(-EI)
<b>Ambient Temperature</b> ①									
Storage	-55...+80°C (-67...176°F)								
Operation at rated current	-25...+60°C (-13...140°F) (40°C per UL)								
Conditioned 15% current reduction	-70°C (158°F)								
<b>Altitude at installed site</b>	2000 meters above sea level per IEC 60947-1								
<b>Resistance to Corrosion / Humidity</b>	Damp-alternating climate: cyclic to IEC 68-2, 56 cycles. Dry heat: IEC 68-2, +100°C (212°F), relative humidity <50%, 7 days Damp tropical: IEC 68-2, +40°C (104°F), relative humidity <92%, 56 days.								
<b>Shock Resistance</b>	IEC 60068-2-27: Half sinusoidal shock 11 ms, 4g (12g in all three directions)								
<b>Vibration Resistance</b>	IEC 60068-2-6: Static >2g, in normal position								
<b>Operating Position</b>	See Dimensions pages								
<b>Standards</b>	IEC/EN 60947-1/-4-1/-5-1; UL508; CSA 22.2 No. 14								
<b>Approvals</b>	CE, cULus, CCC								

## Auxiliary Contacts

		Conventional auxiliary contacts					Suitable for electronic circuits		
<b>Switching, AC &amp; DC Loads</b>									
AC-1 I <sub>th</sub>	at 40°C	[A]	16					0.1A at 250V	
	at 60°C	[A]	12					0.1A at 250V	
AC-15 at rated operating voltage of:		[V]	230	400	415	500	690		
		[A]	5.5	3	2.5	1.6	1	1...100mA at 3...125V	
DC-13, switching electromagnets at:		[V]	24	48	110	220	440		
		[A]	5	2	0.7	0.25	0.12	1...100mA at 3...125V	
<b>Short Circuit Protection - gG Fuse</b>									
Type 2 Coordination		[A]	16					0.1	
<b>Rated Impulse Voltage</b> U <sub>imp</sub>		[kV]	8					1.5	
<b>Load carrying capacity per UL/CSA</b>									
Rated Voltage		[V]	600 max.					250V max.	
Continuous Rating		[A]	10 general purpose						
Switching Capacity			Heavy pilot duty (A600)					0.1A	
Rated Voltage		[V]	600 max.						
Switching Capacity			Standard pilot duty (P600)						
Minimum Switching Capacity			17V, 10mA					17V, 5mA	
<b>Terminals</b>									
Terminal Type									
Maximum Wire Size per IEC 947-1			1...2.5					1...2.5	
 Flexible with Wire-End Ferrule	1 Conductor	[mm <sup>2</sup> ]	1...4					1...4	
 Solid/Stranded-Conductor	2 Conductor	[mm <sup>2</sup> ]	1...4					1...4	
Recommended Tightening Torque		[Nm]	1.4...2.3					1.4...2.3	
Max. Wire Size per UL/CSA		[AWG]	16...12					16...12	
Recommended Tightening Torque		[lb-in]	12...20					12...20	
<b>Degree of Protection</b>	IP2X per IEC 529 and DIN 40 050								

## Contact Ratings (Per UL508/NEMA A600 & Q600)

Standard	Circuit Voltage	Make (Amps/VA)	Break (Amps/VA)	Continuous Amps
A600	120AC	60A/7200VA	6A/720VA	10
	240AC	30A/7200VA	3A/720VA	
	480AC	15A/7200VA	1.5/720VA	
	650AC	12A/7200VA	1.2/720VA	
Q600	125DC	0.55/69VA	0.55A/69VA	2.5
	250DC	0.27A/69VA	0.27A/69VA	
	600AC	0.1A/69VA	0.1A/69VA	

① Ambient is the temperature outside the enclosure.

Life-Load Curves

AC-1 / AC-3

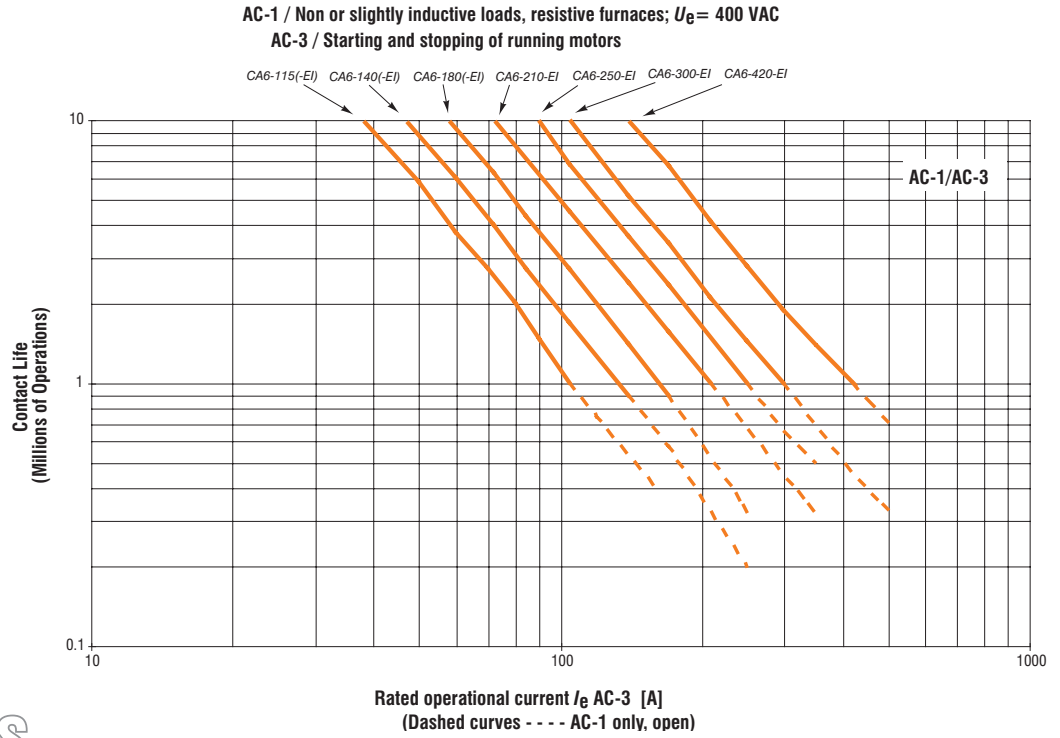

Instructions on  
**How to** read  
Life Curves  
can be found on page A8

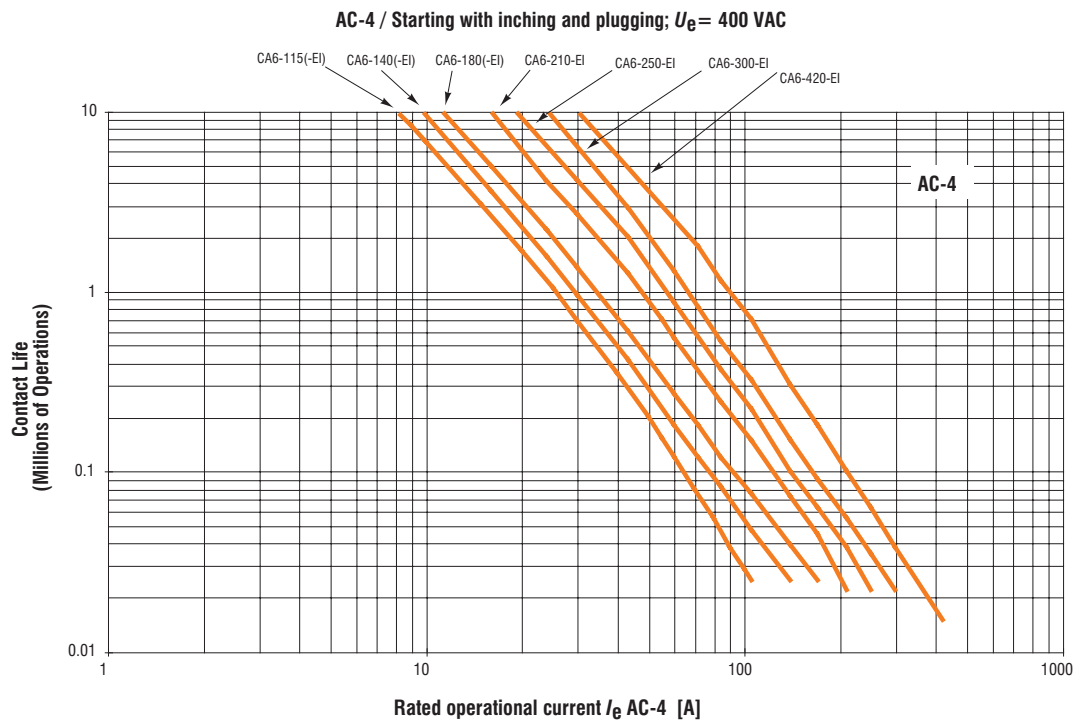

**NOTE:** The life-load curves shown here are based on Sprecher+Schuh tests according to the requirements defined in IEC 947-4-1. Since contact life in any given application is dependent on environmental conditions and duty cycle, actual application contact life may vary from that indicated by the curves shown here.



**A**  
**CA6 Contactors**

**Life-Load Curves**

**AC-3 (90%),  
AC-4 (10%)**

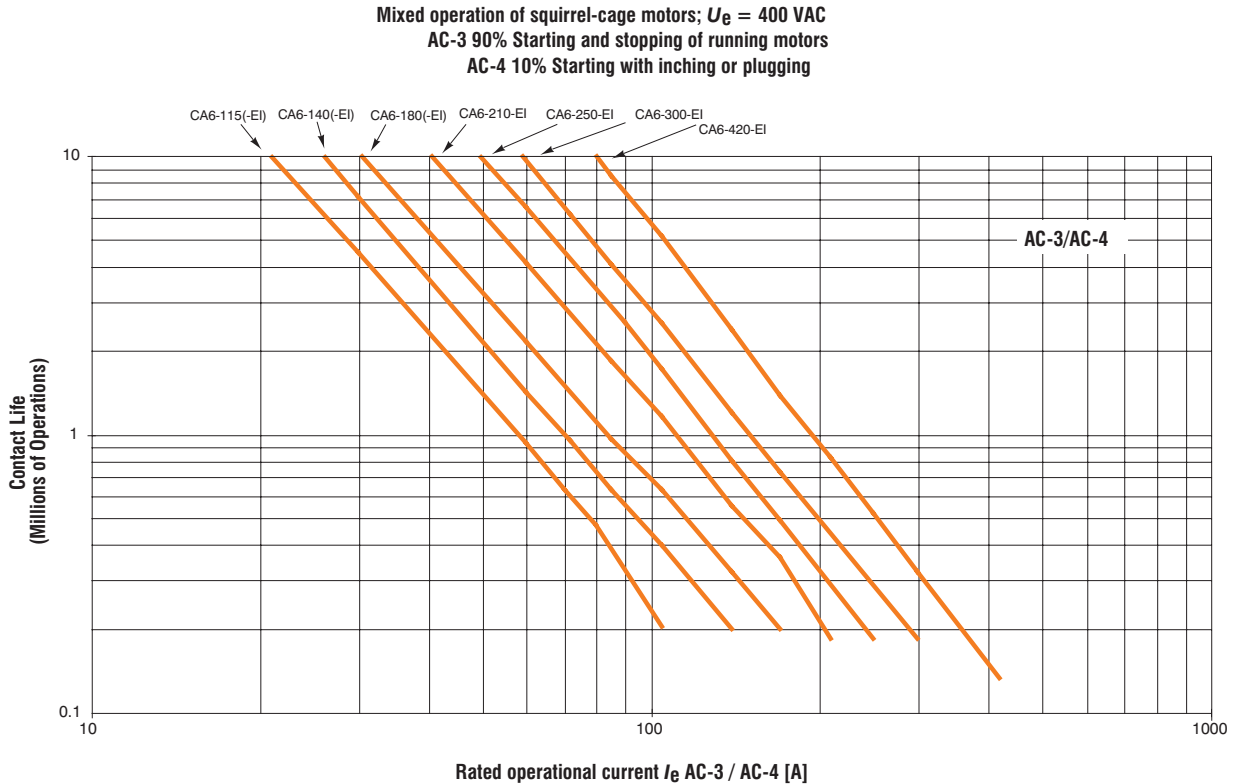

**Contact Life for Mixed Utilization Categories  
AC-3 and AC-4**

In many applications, the utilization category cannot be defined as either purely AC-3 or AC-4. In those applications, the electrical life of the contactor can be estimated with the following equation:

$$L_{\text{mixed}} = L_{\text{ac3}} / [1 + P_{\text{ac4}} \times (L_{\text{ac3}} / L_{\text{ac4}} - 1)], \text{ where:}$$

- $L_{\text{mixed}}$  Approximate contact life in operations for a mixed AC-3/AC-4 utilization category application.
- $L_{\text{ac3}}$  Approximate contact life in operations for a pure AC-3 utilization category (from the AC-3 life-load curve).
- $L_{\text{ac4}}$  Approximate contact life in operations for a pure AC-4 utilization category (from the AC-4 life-load curve).
- $P_{\text{ac4}}$  Percentage of AC-4 operations

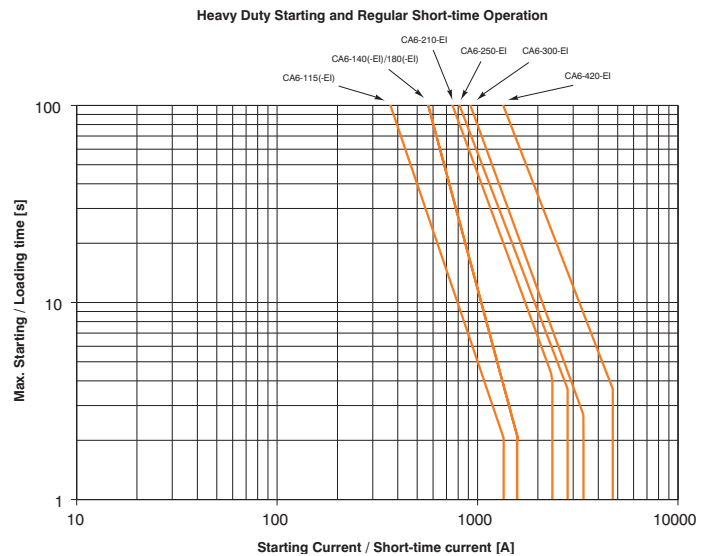

**NOTE:** The life-load curves shown here are based on Sprecher+Schuh tests according to the requirements defined in IEC 947-4-1. Since contact life in any given application is dependent on environmental conditions and duty cycle, actual application contact life may vary from that indicated by the curves shown here.

**Maximum Operating Rates**

Squirrel cage motors; starting, switching off during running;  $U_e = 400 \text{ VAC}$   
250ms start time; 40% duty cycle

**AC-3**  
250ms start time

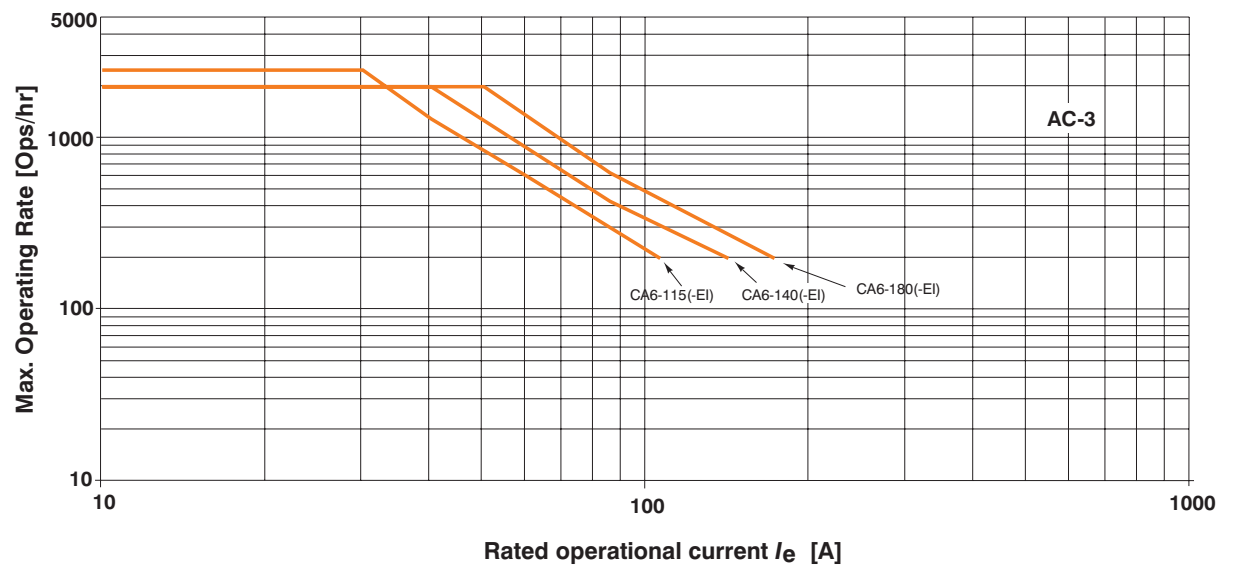

Squirrel cage motors; starting, switching off during running;  $U_e = 400 \text{ VAC}$   
1s start time; 40% duty cycle

**AC-3**  
1 sec. start time

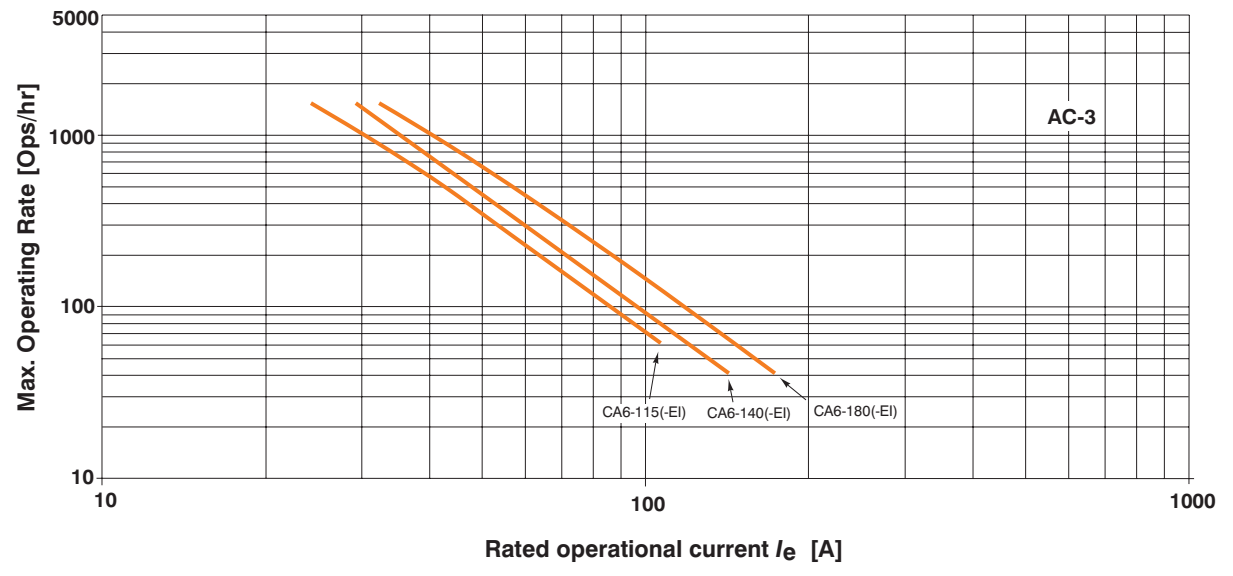

**Series CA6 & Series CAU6 (Contactors & Reversing Contactors)**

Dimensions are in millimeters (inches). Dimensions not intended for manufacturing purposes.

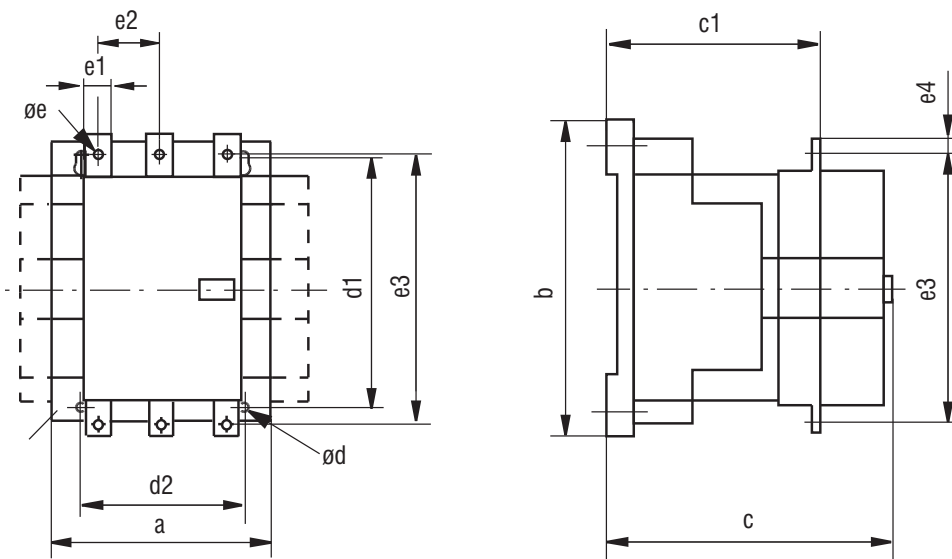

Catalog Number	a	b	c	c1	d	d1	d2	e	e1	e2	e3	e4
CA6-115(-EI); CA6-140(-EI); CA(N)6-180(-EI);	120 (4-3/4)	170 (6-11/16)	156 (6-1/8)	110.5 (4-11/32)	5.2 (7/32)	145 (5-11/16)	100 (3-15/16)	M8	20 (13/16)	39 (1-35/64)	160 (6-19/64)	10 (25/64)
CA6-210-EI...CA6-250-EI CA(N)6-300(-EI); CA6-420-EI	155 (6-1/8)	205 (8-1/16)	180 (7-3/32)	110.5 (4-11/32)	6.5 (9/32)	180 (7-3/32)	130 (5-1/8)	M10	25 (1)	48 (1-7/8)	193 (7-19/32)	12.5 (31/64)
CA6-630-EI...CA6-860-EI	255 (10-3/64)	310 (12-7/32)	265 (10-7/16)	110.5 (4-11/32)	10 (25/64)	230 (9-1/16)	225 (8-55/64)	M12	40 (1-37/64)	70 (2-3/4)	291 (11-29/64)	22 (55/64)

**Reversing Contactors & Accessories (+...)**

Contactor with...	CA6...	Dimension [mm]	Dimension [inches]
- auxiliary contact block ❶	+ S1	a	a
	+ S2	a + 13.5 mm each	a + 9/32 each
- reversing w/mechanical interlock		a + a	a + a
- main terminal set	HB2	b + 7mm each	b + 19/64 each
	HB3	b + 8.5mm each	b + 11/32 each
- label holder		c + 5mm	c + 3/16

**Mounting Position**

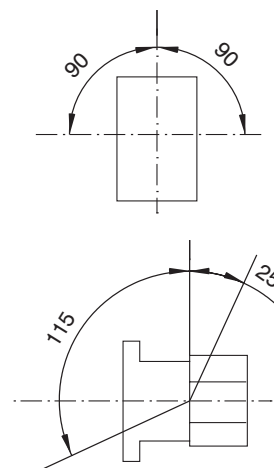

❶ No change of base dimensions with 1 or 2 auxiliary contact blocks (S1 or S2).  
Each dimension increased by 13.5 mm to the "a" dimensions on the right hand side.



# Series CA5 Contactors

CA5 Contactors

The contactor for heavy industrial applications from 500HP to 900HP

CA5 Series contactors provide large horsepower performance with a design that is up to 40% smaller than traditional contactors of this rating. The entire line is modularly designed for easy inspection, contact replacement and coil change out. All maintenance can be performed from the front so that mounting can be accomplished with no wasted space on the sides.

## The contactor for large horsepower applications

The CA5 series consists of four contactors in two frame sizes covering motors from 500 to 900 HP (at 460V/575V). This line is well suited for heavy industrial applications utilizing large machinery and equipment such as rock quarries and mines, or for any large horsepower application where a rugged and dependable contactor is needed.



## Specially designed shock-free contact system

A characteristic of contactors in this size class is to transmit intense impact forces during operation. This is caused by the heavy magnetic armatures of the core, which can cause contact "bounce." CA5 contactors, however, are designed so that the operating planes of the electromagnets and the contacts are opposed to each other by 90°. This results in a bounce-free contact system, increasing the contactor's mechanical life and raising contact reliability.

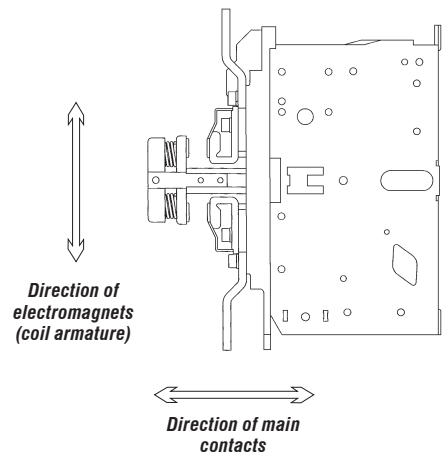

## Rugged and reliable

A massive steel framework supporting the magnet system ensures high stability in all applications. Low-wear materials for bearings and sliding surfaces, as well as generously dimensioned magnet-pole faces result in above average mechanical life with a minimum of maintenance. Despite their rugged construction, overall contactor weight has been reduced considerably permitting simpler panel construction and easier assembly.

**DISCONTINUED**  
This series is being replaced by the CA9 Series of contactors

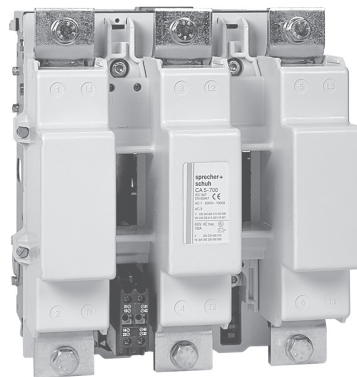

← 280mm (≈11") →  
1000A  
1100A

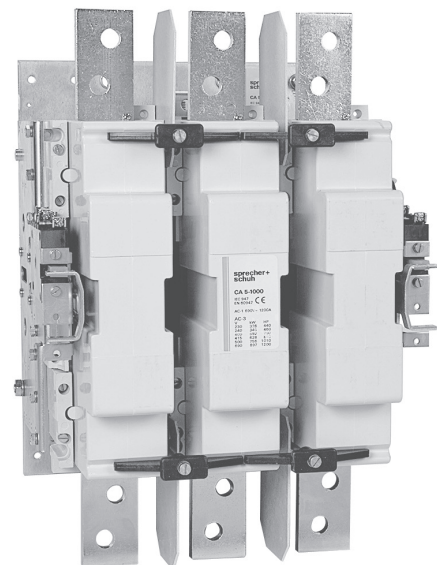

← 334mm (≈13 3/16") →  
1200A  
1350A

## Unique coil “feeder group” offers many advantages

CA5-700 and 860 contactors are equipped with a special “feeder group” for the coil that accommodates AC control voltages of 50 or 60Hz, and a wide range of DC voltages.

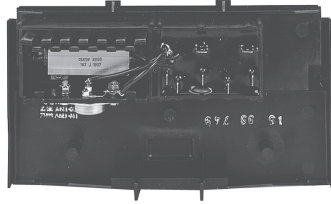

This coil arrangement eliminates noise and provides very low pickup and hold-in current. In addition, the dropout time of the coil can be adjusted within one of three ranges.

**Normal Drop** (150 to 200ms): for prompt reaction of contactor to a breaking command (factory setting).

**Delayed Drop** (0.5 to 1s): where it is necessary for the contactor to be immune to short power supply interruptions or uncertain control devices.

**Fast Drop** (about 20ms): for safety applications where instant dropout is required.

## Adjustable auxiliary contacts

CA5 contactors can be equipped with a maximum of four NO and four NC auxiliary contacts. In addition, the closing time of the auxiliary contacts (on CA5-700 & 860 contactors) can be adjusted to meet individual control requirements.

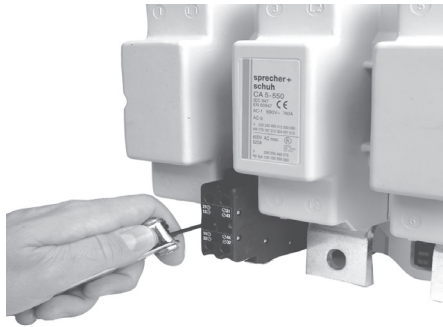

## Add-on fourth pole

In many applications, the neutral also needs to be switched. All CA5 contactors can be fitted with a 4th pole on either the left or right side of the contactor. This switched neutral is available as an accessory that can easily be installed in the field.

## Two choices for interlocking reversing contactors

Unique to the CA5 range is the ability to mechanically interlock reversing contactors in either a horizontal or vertical orientation. This feature allows maximum flexibility when laying out panels.

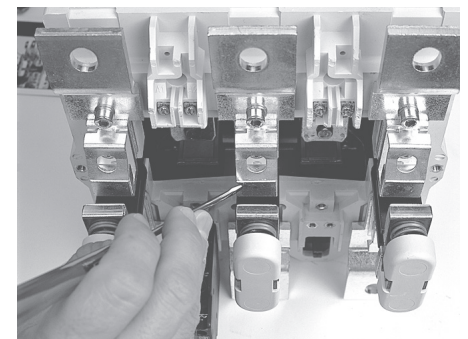
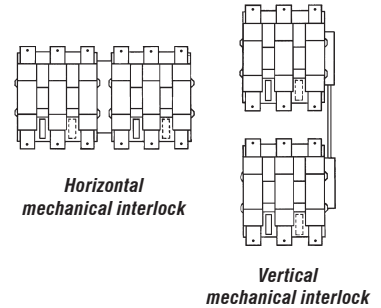

Simple main contact inspection and easy coil change

**DISCONTINUED**

## Modular, convenient design

The CA5 line is modularly designed for easy inspection, coil change and contact replacement. Maintenance can be performed from the front so that mounting requires no additional space. Even with the installation of mechanical interlocks and auxiliary contact blocks, the units can be flush mounted side by side, saving panel space.

- 1 CA5-700 Contactor
- 2 CA5-1000 Contactor
- 3 Coil Pair
- 4 Feeder Group
- 5 4th Pole (Neutral Switching)
- 6 Auxiliary Contact Block
- 7 Auxiliary Contact Block
- 8 Mechanical Interlock (horizontal)
- 9 Mechanical Interlock (vertical)

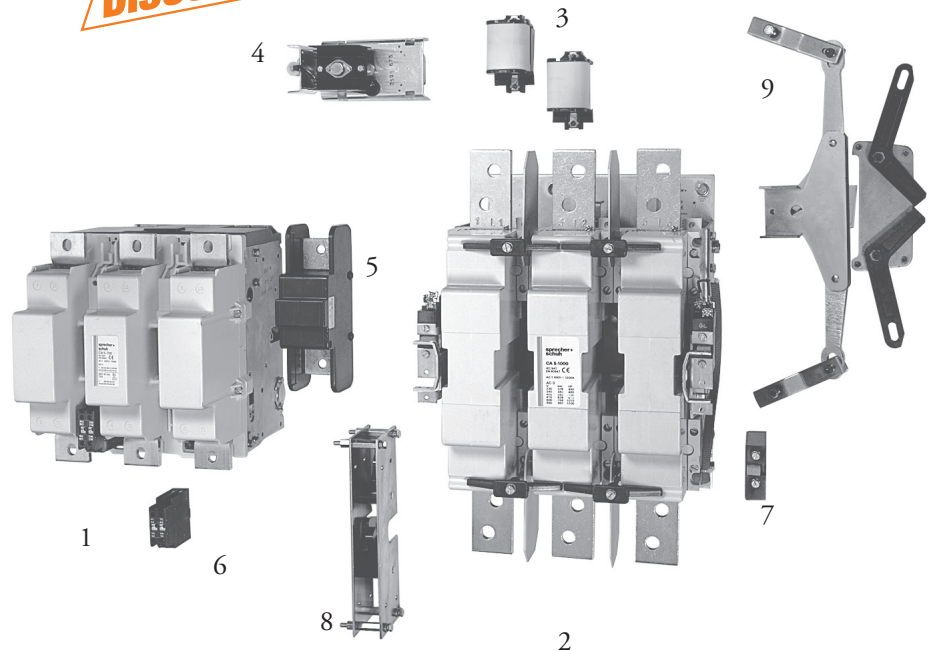

A full range of CA5 accessories is available, including a unique mechanical interlock that allows vertical mounting of contactors (see explanation above)

### Non-Reversing, Three Pole Contactors With AC or DC Coil, Series CA5 (Open type only) ①③

I <sub>e</sub> [A]		Ratings for Switching AC Motors (AC2 / AC3 / AC4)								Auxiliary Contacts per Contactor		Open Type	
		kW (50 Hz)				UL/CSA HP (60 Hz) ②							
		3 Ø											
AC-3	AC-1	230V	400V 415V	500V	690V	200V	230V	460V	575V	NO	NC	Catalog Number ①③	Price
700	1000	220	400	500	630	200	250	500	500	2	2	CA5-700-22-*	12232.42
860	1100	280	500	630	710	250	300	600	600	2	2	CA5-860-22-*	14950.74
1000	1200	315	560	750	850	~	~	~	~	1	2	CA5-1000-12-*	17459.95
1200	1350	375	710	850	1000	450	450	900	900	1	2	CA5-1200-12-*	21223.77

**Note:** CA5 open-type contactors include terminal bolts. See page A160 for Lugs.

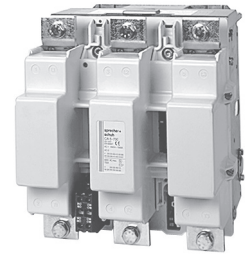

CA5-700-22 contactor

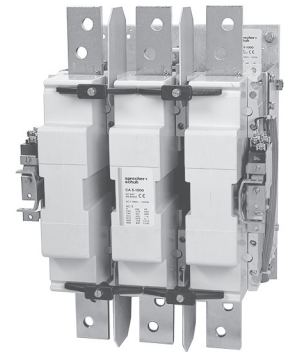

CA5-1000-12 contactor

### Coil Codes ①②





CA5-700 / 860				CA5-1000 / 1200		
AC & DC Coil Code	Voltage Range			AC Coil Code	Voltage Range	
	50 Hz	60 Hz	VDC		50 Hz	60 Hz
120	110-120V	110-120V	100-110VDC	110	110V	110V
240	220-240V	220-240V	200-220VDC	220	220V	220V
380	380-415V	380-415V	345-380VDC	380	380V	380V
480	440-480V	440-480V	400-440VDC	440	440V	440V
				480	440-480V	440-480V

### Ordering Instructions

Specify Catalog Number	
Replace (*) with Coil Code	See Coil Codes on this page

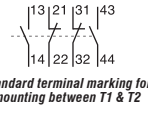
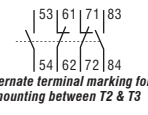
- ① CA5-700 and 860 contactors are equipped with coils that operate with both AC and DC control voltages. CA5-1000 and 1200 contactors operate with AC control voltage input that is rectified for DC coil operation. See page A161. Consult factory for DC control voltage input.
- ② Other voltages available, see page A161.
- ③ CA5-1000 horsepower ratings per IEC Utilization category AC-3. See CA5 Technical Data section for additional sizing information. Label does not bear a UL/CSA horsepower rating.

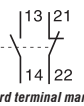
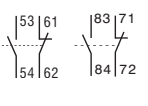
**Auxiliary Contact Blocks (2 & 4 Pole)**

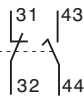
Contact Block	Description	NO	NC	Contact Arrangement	For use with...	Catalog Number	Price
 <p><b>4-pole</b></p>	<ul style="list-style-type: none"> <li>For mounting between T1 &amp; T2 or between T2 &amp; T3</li> <li>Adjustable; provides normal, delayed or overlapping contacts ①</li> <li>Maximum two blocks per contactor ②</li> <li>Alternate terminal marking tags included</li> </ul>	2	2	 <p>Standard terminal marking for mounting between T1 &amp; T2</p>  <p>Alternate terminal marking for mounting between T2 &amp; T3</p>	CA5-700 CA5-860	<b>CA5-EF22 ②</b>	<b>476.75</b>
 <p><b>2-pole</b></p>	<ul style="list-style-type: none"> <li>For side mounting on either side of the contactor</li> <li>Maximum four blocks per contactor ③</li> <li>Alternate terminal marking tags included</li> </ul>	1	1	 <p>Standard terminal marking</p> 	CA5-1000 CA5-1200	<b>CA5-EB11 ③</b>	<b>757.99</b>
 <p><b>2-pole</b></p>	<ul style="list-style-type: none"> <li>One supplied standard with contactor</li> <li>Special two pole design; 1 NO delayed make, 1 NC</li> <li>NO delayed make contact used for operation of the Feeder Group/Coil mechanism</li> </ul>	1 <b>Delayed Make</b>	1		CA5-1000 CA5-1200	<b>CA5-EB11DC</b>	<b>835.36</b>

**Switched Neutral (4th Pole) ④**

4th Pole	4th Pole Amperes I <sub>th</sub> AC-1	For use with...	Catalog Number	Price
	500	CA5-700 CA5-860	<b>CA5-NP500/6</b>	<b>1181.42</b>
	1000	CA5-700 CA5-860	<b>CA5-NP1000/6</b>	<b>1547.35</b>
		CA5-1000 CA5-1200	<b>CA5-NP1000/7</b>	<b>2331.48</b>

① Further information on adjustable contacts can be found under “Auxiliary Contacts” in the CA5 Technical Section.

② Contactor comes standard with one 4-pole aux contact block.

③ In addition to one standard two-pole auxiliary contact block (CA5-EB11), CA5-1000 & 1200 contactors are equipped from the factory with a special two pole auxiliary contact block (CA5-EB11DC). One of the poles is used for operation of the Feeder Group/Coil mechanism, the other NC contact is available for use. Two additional aux contact blocks may be added for a total of four.

④ No UL or cUL approval.

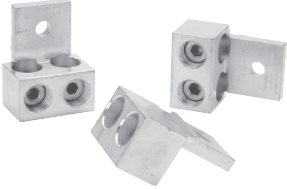

**Main Lugs**

Lug or Accessory	Description	Wire Size	Catalog Number	Price
	Screw Type Lugs - (set of 6) For CA5-700 For CA5-860 For CA5-1000 & CA5-1200 ❶	(2) 3/0- 750MCM (3) 2- 600MCM (4) 1/0- 750MCM	CA5-700-LU CA5-860-LU CA5-1200-LU	443.30 1151.10 1327.79

**Mechanical Interlock Kit**

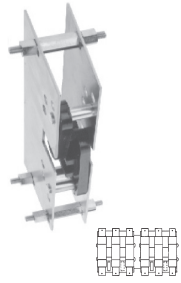
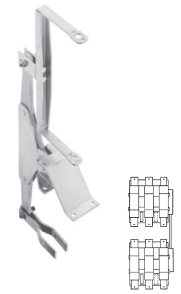
For Horizontal Mounting of Contactors			
Interlock	For use with...	Catalog Number	Price
	CA5-700 CA5-860 CA5-700/CA5-860	CA5-BM6H	791.44
	CA5-700/CA5-1000 CA5-700/CA5-1200 CA5-860/CA5-1000 CA5-860/CA5-1200	CA5-BM67H	2415.12
	CA5-1000 CA5-1200 CA5-1000/CA5-1200	CA5-BM7H	1495.07
For Vertical Mounting of Contactors			
	CA5-700 CA5-860 CA5-700/CA5-860	CA5-BM6V	791.44
	CA5-700/CA5-1000 CA5-700/CA5-1200 CA5-860/CA5-1000 CA5-860/CA5-1200	CA5-BM67V	2415.12
	CA5-1000 CA5-1200 CA5-1000/CA5-1200	CA5-BM7V	1495.07

**Mechanical Latch**

Latch	For use with...	Catalog Number	Price
	CA5-700 CA5-860	CA5-AM6-*	1442.80



CA5-AM6-*	
Replace * with Coil Code	
AC Coil Code	Voltage Range
120	110V - 120V
240	220V - 240V
415	380V - 415V
480	440V - 480V

❶ CA5-1000 is not UL Listed.

All CA5 contactor coils are made up of two parts; the Coil Pair and Feeder Group. When ordering replacement parts, usually assume the Coil Pair must be replaced. If control voltage changes, user must order Coil Pair and matching Feeder Group.

Even though all CA5 coils are designed for AC *input* (DC input also available for CA5-550...860 contactors), they are operated by a DC voltage *supplied* from a “feeder group”. Always order by

the Coil Code matched to the **actual control voltage available to the contactor.**

Further information on CA5 coil pairs and feeder groups can be found in CA5 Technical Information.

**AC & DC Coil Pairs & Feeder Groups (CA5-550 to CA5-860) ①②**

Voltage Range	COIL CODES	CA5-550		CA5-700 & CA5-860	
		Coil Pair	Feeder Group	Coil Pair	Feeder Group
110-120V 50/60Hz 100-110VDC	<b>120</b>	TX734 (22.807.301-10)	TXS734 (22.807.204-10)	TY734 (22.809.301-10)	TYS734 (22.809.204-10)
220-240V 50/60Hz 200-220VDC	<b>240</b>	TX747 (22.807.301-13)	TXS747 (22.807.204-13)	TY747 (22.809.301-13)	TYS747 (22.809.204-13)
380-415V 50/60Hz 345-380VDC	<b>380</b>	TX779 (22.807.301-16)	TXS779 (22.807.204-16)	TY779 (22.809.301-16)	TYS779 (22.809.204-16)
440-480V 50/60Hz 400-440VDC	<b>480</b>	TX780 (22.807.301-18)	TXS780 (22.807.204-18)	TY780 (22.809.301-18)	TYS780 (22.809.204-18)
<b>Price</b>		<b>1000.55</b>	<b>972.32</b>	<b>1223.24</b>	<b>1160.51</b>

**AC Coil Pairs & Feeder Groups (CA5-1000 & CA5-1200) ①②**

Voltage Range	AC COIL CODES	CA5-1000 & CA5-1200	
		Coil Pair	Feeder Group
110-115 Volts 50/60Hz	<b>110</b>	TZ734 (22.811.301-10)	TZS734 (22.811.204-10)
220-230 Volts 50/60Hz	<b>220</b>	TZ747 (22.811.301-13)	TZS747 (22.811.204-13)
380-400 Volts 50/60Hz	<b>380</b>	TZ779 (22.811.301-16)	TZS779 (22.811.204-16)
440 Volts 50/60Hz	<b>440</b>	TZ780 (22.811.301-18)	TZS780 (22.811.204-18)
440-480 Volts 50/60Hz	<b>480</b>	TZ781	TZS781
<b>Price</b>		<b>1955.10</b>	<b>3376.98</b>

**DC Coil Pairs & Feeder Groups (CA5-1000 & CA5-1200) ②③**

Voltage Range	DC COIL CODES	CA5-1000 & CA5-1200	
		Coil Pair	Feeder Group
110 Volts DC	<b>110D</b>	Refer to factory	Refer to factory
220 Volts DC	<b>220D</b>	Refer to factory	Refer to factory
440 Volts DC	<b>480D</b>	Refer to factory	Refer to factory
<b>Price</b>		Refer to factory	Refer to factory

- ① Other voltages available. Please contact factory.
- ② CA5-550, 700 and 860 contactors are equipped with coils that operate with both AC and DC control voltages. For DC coil operation, select AC Coil Code for desired DC voltage. CA5-1000 and 1200 contactors operate with AC control voltage input that is rectified for DC coil operation. See page A167. Consult factory for DC control voltage input.



CA5 Coil Pair (typical)

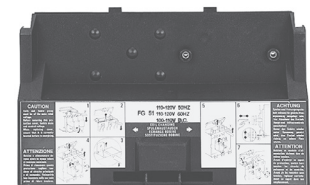

CA5 Feeder Group - front view (typical)

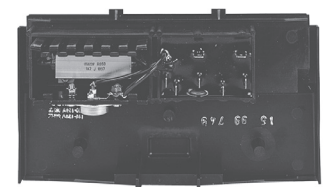



CA5 Feeder Group - rear view (typical)

**A**  
CA5 Contactors

**Main Contact - (1 Pole Per Set)**

Main Contacts (1pole) <i>(typical)</i>	For use with...	Catalog Number	Price per pole
	CA5-550	<b>CA5-CP550</b> (22.807.202-01)	<b>318.88</b>
	CA5-700	<b>CA5-CP700</b> (22.808.202-01)	<b>479.89</b>
	CA5-860	<b>CA5-CP860</b> (22.809.202-01)	<b>635.67</b>
	CA5-1000	<b>CA5-CP1000</b> (22.810.202-01)	<b>801.90</b>
	CA5-1200	<b>CA5-CP1200</b> (22.811.202-01)	<b>959.78</b>

**Arc Chutes**

Arc Chutes <i>(typical)</i>	For use with...	Catalog Number	Price
 <p>3-pole (1 per contactor)</p>	CA5-550	<b>CA5-AC550</b> (22.807.201-01)	<b>930.50</b>
	CA5-700/ CA5-860	<b>CA5-AC860</b> (22.809.201-01)	<b>1505.53</b>
 <p>1-pole (3 per contactor)</p>	CA5-1000/ CA5-1200	<b>CA5-AC1200</b> (22.811.201-01)	<b>1029.82</b>

**Technical Information**

			CA5-550	CA5-700 ❶	CA5-860	CA5-1000	CA5-1200	
<b>Rated Insulation Voltage <math>U_i</math></b>								
to IEC947-1	[V]		690	690	690	690	690	
UL/CSA	[V]		600	600	600	600	600	
<b>Rated Impulse Voltage <math>U_{imp}</math></b>								
CA5-550 / 700 / 860	[kV]		8	8	8	8	8	
CA5-1000 / 1200	[kV]		2.5	2.5	2.5	2.5	2.5	
<b>Rated Voltage <math>U_e</math>-Main Contacts</b>								
AC 50/60Hz	[V]		220/230, 240, 380/400, 415, 500, 660/690 (1000V - CA5-550 to 860)					
DC	[V]		24, 48, 110, 220, 440V					
<b>Operating Frequency for AC Loads</b>	[Hz]	50/60Hz	180/hr. for 0.25s start time - 42/hr. for 1s start time					
<b>Switching Motor Loads</b>								
<b>Standard IEC Ratings</b>								
<b>AC-2, AC-3</b>		230/240V	[A]	550	700	860	1000	1200
DOL & Reversing		400/415V	[A]	550	700	860	1000	1200
50Hz/60° C		500V	[A]	550	700	860	1000	1200
		690V	[A]	500	630	700	860	1000
		230V	[kW]	179	228	280	326	391
		240V	[kW]	187	238	293	340	408
		400V	[kW]	312	414	509	592	710
		415V	[kW]	324	430	528	628	737
		500V	[kW]	407	518	636	756	888
		690V	[kW]	510	657	730	897	1043
<b>UL/CSA</b>		200V	[A]	414	552	692	~	1185
DOL & Reversing		230V	[A]	360	602	722	~	1130
60Hz		460 V	[A]	414	590	708	~	1062
	3∅	575 V	[A]	336	472	576	~	864
		200 V	[HP]	150	200	250	~	450
		230 V	[HP]	150	250	300	~	450
		460 V	[HP]	350	500	600	~	900
		575 V	[HP]	350	500	600	~	900
<b>AC4 -200,000 Op. Cycles</b>		230/240V	[A]	140	180	210	260	300
50Hz		400/415V	[A]	140	180	210	260	300
		230V	[kW]	45	57	67	83	97
		240V	[kW]	47	60	70	87	101
		400V	[kW]	78	101	118	146	170
		415V	[kW]	81	105	122	151	176
<b>AC4 -200,000 Op. Cycles (25,000)</b>		230/240V	[A]	360	430	520	(630)	(700)
Squirrel-cage motors with reversing and jogging		400/415V ❶	[A]	350	420	520	(630)	(700)
		230V	[kW]	116	139	170	(205)	(228)
		240V	[kW]	120	151	177	(214)	(245)
		400V	[kW]	198	238	295	(357)	(414)
		415V	[kW]	206	247	300	(359)	(424)

❶ At rated voltage (415V) and rated current: Life span –25%.

**A**

**CA5 Contactors**

**Electrical Data**

			CA5-550	CA5-700	CA5-860	CA5-1000	CA5-1200	
<b>Switching Motor Loads (continued)</b>								
<b>Wye-Delta (Star Delta)</b>	50 Hz	230V	[A]	953	1212	1490	1732	2078
		240V	[A]	953	1212	1490	1732	2078
		400V	[A]	953	1212	1490	1732	2078
		415V	[A]	953	1212	1490	1732	2078
		500V	[A]	953	1212	1490	1732	2078
		690V	[A]	831	1091	1195	1490	1732
	60 Hz	230V	[kW]	310	395	485	565	677
		240V	[kW]	324	412	507	589	707
		400V	[kW]	540	717	882	1025	1250
		415V	[kW]	561	745	915	1088	1278
		500V	[kW]	705	897	1102	1309	1538
		690V	[kW]	883	1138	1247	1554	2078
<b>AC-1 Load, 3Ø Switching</b>	Ambient Temperature 40° C	$I_{th}$	[A]	760	1000	1100	1200	1350
		230V	[kW]	303	398	438	478	538
		240V	[kW]	316	416	457	499	561
		400V	[kW]	527	693	762	831	935
		415V	[kW]	546	719	791	863	970
		500V	[kW]	658	866	953	1039	1169
	Ambient Temperature 60° C	$I_{th}$	[A]	605	800	870	960	1085
		230V	[kW]	241	319	347	382	432
		240V	[kW]	251	333	362	399	451
		400V	[kW]	419	554	603	665	752
		415V	[kW]	435	575	625	690	780
		500V	[kW]	524	693	753	831	940
<b>Continuous Current (UL/CSA)</b>	General Purpose Rating (40° C)		[A]	520	700	810	~	1215
<b>Rated Making Capacity</b>	415V	[A]	5500	7000	8600	10000	12000	
	500V	[A]	5500	7000	8600	10000	12000	
	690V	[A]	5500	7000	8600	10000	12000	
<b>Rated Breaking Capacity</b>	AC-3 $I_b$	240V	[A]	4400	5600	6900	8000	9600
		400V	[A]	4400	5600	6900	8000	9600
		415V	[A]	4400	5600	6900	8000	9600
		500V	[A]	4400	5600	6900	8000	9600
		690V	[A]	4000	5100	5600	6900	8000
<b>Short Circuit Protection of Contactors Without Overload Relay</b>								
Fuse gG (aM) Type 1 Coordination (per IEC 60947-4-1)	500V	[A]	(630)	800	1000	1000	1250	
	690V	[A]	(630)	800	1000	1000	1000	

**Electrical Data**

				CA5-550	CA5-700	CA5-860	CA5-1000	CA5-1200
<b>DC Ratings</b>								
<b>DC-1 Rating at 60° C</b>								
Non-inductive or slightly inductive loads, resistive furnaces	1 pole	24VDC	[A]	645	760	930	1020	1150
		48VDC	[A]	645	760	930	1020	1150
	2 Poles in Series	24VDC	[A]	645	760	930	1020	1150
		48VDC	[A]	645	760	930	1020	1150
		110VDC	[A]	480	560	630	800	900
		220VDC	[A]	315	400	450	500	600
	3 Poles in Series	24VDC	[A]	605	800	870	960	1085
		48VDC	[A]	605	800	870	960	1085
		110VDC	[A]	480	560	630	800	900
		220VDC	[A]	315	400	450	500	600
<b>DC-3 Rating at 60° C</b>								
Shunt wound motors - Starting, reverse current breaking, reversing, stepping	3 Poles in Series	24VDC	[A]	605	800	870	960	1085
		48VDC	[A]	605	800	870	960	1085
<b>DC-5 Rating at 60° C</b>								
Series wound motors - Starting, reverse current breaking, reversing, stepping	3 Poles in Series	24VDC	[A]	605	800	870	900	1085
		48VDC	[A]	605	800	870	900	1085
<b>Lighting Loads</b>								
Elec. Dischrg. Lamps-AC-5a, single compensated	Open		[A]	450	570	700	850	1000
			[A]	360	460	550	660	800
Incandescent Lamps - AC AC-5b, Electrical endurance ~100,000 operations	En-closed		[A]	315	440	500	560	630
			[A]	315	440	500	560	630
<b>Switching power transformers AC-6a</b>								
Inrush = $nxI_e$								
Rated transformer current								
n = 30	Inrush	400 VAC	[A]	7,440	9,450	11,700	13,500	16,200
		400 VAC	[A]	248	315	390	450	540
		400 VAC	[kVA]	172	218	270	312	374
		500 VAC	[kVA]	215	273	338	390	468
		690 VAC	[kVA]	269	339	376	538	645
n = 20		400 VAC	[A]	371	472	580	675	810
n = 15		400 VAC	[A]	435	630	774	900	1080
Rated making Capacity								
AC-3 I <sub>e</sub>		≤415V	[A]	5,500	7,000	8,600	10,000	12,000
		500V	[A]	5,500	7,000	8,600	10,000	12,000
		690V	[A]	5,500	7,000	8,600	10,000	12,000
Rated making Capacity								
AC-3 I <sub>e</sub>		≤240V	[A]	4,400	5,600	6,900	8,000	9,600
		400V	[A]	4,400	5,600	6,900	8,000	9,600
		415V	[A]	4,400	5,600	6,900	8,000	9,600
		500V	[A]	4,400	5,600	6,900	8,000	9,600
		690V	[A]	4,000	5,100	5,600	6,900	8,000

**A**

**CA5 Contactors**

**Electrical Data**

			CA5-550	CA5-700	CA5-860	CA5-1000	CA5-1200
<b>Capacitor Ratings</b>							
<b>Capacitor Switching - 50Hz</b>							
Single Capacitor - 40°C	230 V	[kVar]	180	220	250	290	330
	240 V	[kVar]	200	250	300	325	360
	400 V	[kVar]	320	400	450	500	575
	415 V	[kVar]	350	430	500	550	630
	500 V	[kVar]	450	520	600	660	750
	690 V	[kVar]	580	700	800	875	1000
	Single Capacitor - 55°C	230 V	[kVar]	150	180	220	275
240 V		[kVar]	170	200	260	300	350
400 V		[kVar]	280	330	400	460	550
415 V		[kVar]	300	360	450	500	600
500 V		[kVar]	360	420	540	600	720
690 V		[kVar]	500	580	720	800	950
Capacitor Bank - 40°C		230 V	[kVar]	180	220	250	290
	240 V	[kVar]	200	250	300	325	360
	400 V	[kVar]	320	400	450	500	575
	415 V	[kVar]	350	430	500	550	630
	500 V	[kVar]	450	520	600	660	750
	690 V	[kVar]	580	700	800	875	1000
	Capacitor Bank - 55°C	230 V	[kVar]	150	180	220	275
240 V		[kVar]	170	200	260	300	350
400 V		[kVar]	280	330	400	460	550
415 V		[kVar]	300	360	450	500	600
500 V		[kVar]	360	420	540	600	720
690 V		[kVar]	500	580	720	800	950
<b>Short-Circuit Coordination</b>							
<b>Short Time Current Withstand Ratings</b>							
$I_{cw}$ 60°C	1 s	[A]	5500	7000	8000	10000	12000
	4 s	[A]	5500	7000	8000	10000	12000
	10 s	[A]	4400	5600	6900	8000	9600
	15 s	[A]	3800	5000	6000	7400	8500
	60 s	[A]	2300	2800	3400	4000	4800
	240 s	[A]	1300	1800	2000	2300	2700
	900 s	[A]	850	1150	1350	1600	1900
Off Time Between Operations	[Min.]	60	60	60	60	60	
<b>Resistance and Watt Loss <math>I_g</math> AC3</b>							
Resistance per power pole	[mΩ]	0.11	0.1	0.08	0.06	0.05	
Watt Loss - 3 power poles	[W]	99	147	177	180	216	
Coil and 3 power poles (including series resistor)	AC	[W]	110	172	202	250	286
	DC	[W]	109	169	199	240	276

**Electrical Data**

			CA5-550	CA5-700	CA5-860	CA5-1000	CA5-1200
<b>Coil Data</b>							
<b>Voltage Range</b>							
AC: 50Hz, 60Hz, 50/60 Hz	Pickup	[ $xU_s$ ]	0.85...1.1	0.85...1.1		0.85...1.1	
	Dropout	[ $xU_s$ ]	0.2...0.5	0.20...0.75		0.1...0.6	
DC	Pickup	[ $xU_s$ ]	0.85...1.1	0.85...1.1		0.85...1.1	
	Dropout	[ $xU_s$ ]	0.2...0.5	0.20...0.75		0.1...0.6	
<b>Coil Consumption</b>							
AC: 50Hz, 60Hz, 50/60 Hz	Pickup	[VA]	800...950	1350...1600		2400	
	Hold-in	[VA]	9...11	21...25		70	
DC	Pickup	[VA]	700...850	1350...1600		2400	
	Hold-in	[W]	8...10	21...25		70	
<b>Operating Times</b>							
AC: 50Hz, 60Hz, 50/60 Hz	Pickup	[ms]	50...100	50...100		50...100	
	Normal Dropout	[ms]	150...200	150...200		25...50	
	Delayed Dropout	[ms]	500...1000	500...1000		~	
	Accelerated Dropout	[ms]	20...50	20...50		~	
DC	Pickup	[ms]	50...100	50...100		50...100	
	Normal Dropout	[ms]	150...200	150...200		25...50	
	Delayed Dropout	[ms]	500...1000	500...1000		~	
	Accelerated Dropout	[ms]	20...50	20...50		~	
<b>Insulation Class</b>						Class "B" to VDE 0660 table 22	

**Control and Magnet System for CA5-700...CA5-860 Contactors**

Even though the **input** to the magnet system can either be AC or DC, the low pull-in and holding consumption of the magnet system is achieved by DC operating coils **supplied** by a "Feeder Group". The Feeder Group for these contactors also allows delayed, normal or accelerated dropout times, selectable between 20ms and 1000ms.

- Delayed: (500...1000ms)
- Normal: (150...200ms)
- Accelerated: (20...50ms)

As supplied, the contactors are wired for a normal dropout time. To compensate for wide voltage fluctuations or brief supply voltage interruptions, the dropout time can be delayed by wiring changes made to the Feeder Group at installation.

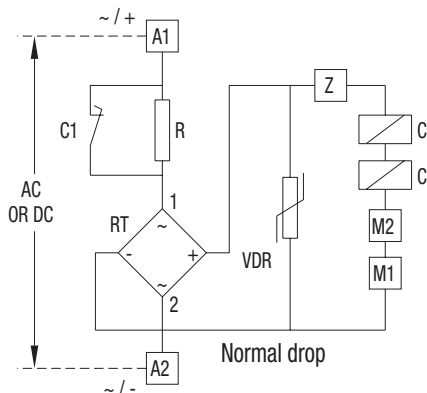

**Coil Circuit for CA5-550, 700 & 860**  
AC or DC supply

**Control and Magnet System for CA5-1000...CA5-1200 Contactors**

Even though the **input** to the magnet system is only designed for AC voltages, the low pull-in and holding consumption of the magnet system is achieved by DC operating coils **supplied** by a "Feeder Group". The Feeder Group for these contactors is configured for a dropout time of 25...50ms. Dropout times for these contactors are not selectable.

Further information regarding circuit possibilities can be obtained from assembly instructions supplied with each device.

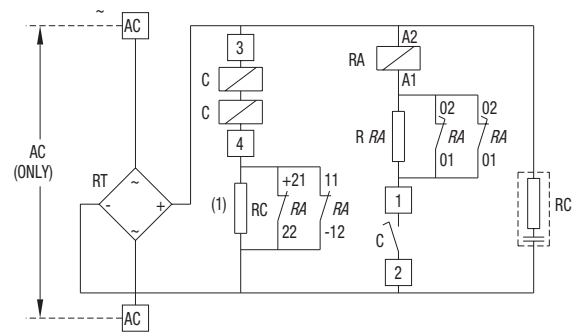





**Coil Circuit for CA5-1000 & 1200**  
AC supply (only)

- C:** Coil pair
- RA:** DC auxiliary relay coil for economy resistor switching
- R, RC, RRA:** Economy resistor
- VDR:** Varistor
- M1, M2:** Terminals for fast-drop connection
- Z:** Device for dropout operating time variation
- (1)** For control voltages up to 125V NC contacts 11-12 & 21-22 are connected in parallel; higher voltages are connected in series





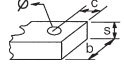
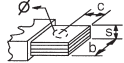
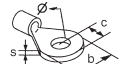

**Mechanical Data**

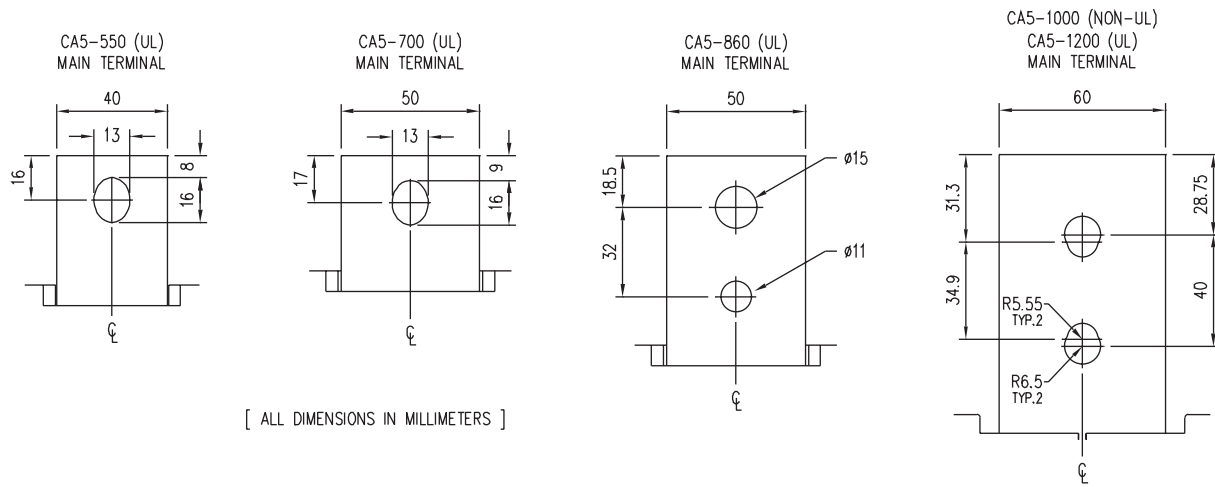
			CA5-550	CA5-700	CA5-860	CA5-1000	CA5-1200
<b>Service Life</b>							
Mechanical	AC Control	[Mil.]	5	5	5	1	1
	DC Control	[Mil.]	5	5	5	1	1
Electrical	AC-3 (400V)	[Mil.]	0.6	0.6	0.6	0.6	0.6
<b>Shipping Weights</b>							
AC - CA5	AC Control	[kg]	13.8	26.4	28.4	50.3	53.4
	DC Control	[Lbs]	30.4	58.1	62.5	110.8	117.6
AC - CAU5	AC Control	[kg]	28.5	53.9	57.9	102.3	108.5
	DC Control	[Lbs]	63.6	120.3	129.2	228.3	242.2
<b>Terminations - Power</b>							
Type							
				Hexagonal Bolt			
Direct Connection (customer supplied connections)							
	b max.	[mm]	50	60	60	60	60
	c max.	[mm]	20	20	25	25	25
	s max.	[mm]	2 x 5	2 x 5	2 x 6	2 x 6	2 x 8
	Ø min.	[mm]	Refer to CA5 stab dimensions below				
Recommended Torque		[Nm]	50	60	75	60	60
		[Lb-ft]	37	44	55	44	44

**CA5 Stab Dimensions**







**Mechanical Data (continued)**

	CA5-550	CA5-700	CA5-860	CA5-1000	CA5-1200
<b>Terminations - Control</b>					
Description	Combination Screw Head: Cross, Slotted, Pozidrive				
Coils	1 or 2	[mm2]	4		
Wires		[AWG]	25		
Control Modules	1 or 2	[mm2]	4		
Wires		[AWG]	25		
Torque Requirement		[Nm]	1..2.5		
		[Lb-in]	8.9...22		
<b>Degree of Protection - contactor</b>	IP00 (open) per IEC 60529 and DIN 40 050				
<b>Environmental and General Specifications</b>					
<b>Rated Isolation Voltage <math>U_i</math></b>					
IEC, AS, BS, SEV, VDE 0660	[V]	1000V		690V	
UL/CSA	[V]	600V		600V	
<b>Impulse Voltage - <math>U_{imp}</math></b>					
1 minute per IEC 60947-1	[kV]	8kV		2.5kV	
<b>Ambient Temperature</b>					
Storage	-40...+80° C (-13...176° F)				
Operation at rated current	-25...+70° C (-13...158° F) (40° C per UL)				
<b>Altitude at installed site</b>	2000 meters above sea level per IEC 60947-1				
<b>Operating Frequency for AC Loads</b>					
50/60 Hz	180/Hr. for 0.25, start time 42/ HR for 1s start time				
<b>Resistance to Corrosion / Humidity</b>	Damp-alternating climate: cyclic per DIN 50 016 and 40 046 Part 38 IEC 60068				
	Dry heat: IEC 68-2, + 100° C (212° F), relative humidity ,50%, 7 days				
	Damp tropical: IEC 68-2, +40° C (104° F), relative humidity 95%, 56 days ❶				
<b>Operating Position</b>	See dimensions page				
<b>Standards</b>	IEC/EN 60947, ul508, csa C22.2 No. 14				
<b>Approvals</b>	cULus, CE				

❶ Per DIN 50 016 and 40 046, part 38.

**Auxiliary Contacts**

		Auxiliary Contact Block								Auxiliary Contact Blocks								
Switching, AC & DC Loads		CA5-EF22								CA5-EB11, CA5-EB11DC								
AC- $I_m$	at 40°C	[A]	16								16							
	at 60°C	[A]	12								12							
AC-15, switching electromagnetic loads at:		[V]	120	230	240	400	415	500	690	120	230	240	400	415	500	690		
		[A]	6	3	3	2	2	1.5	1	6	3	3	2	2	1.5	1		
DC-13, switching DC electromagnets at:		[V]	24 48 110 220								24 48 110 220							
		[A]	6 3 1 0.5								6 3 1 0.5							
<b>Minimum Switching Capacity</b>			10V, 5MA								-							
<b>Short-Circuit Protection - gGFuse</b>																		
Type 2 Coordination		[A]	10								16							
<b>Terminals</b>																		
Terminal Type																		
Maximum Wire Size per IEC 947-1			2 x A4								2 x A4							
	Flexible with Wire-End Fernule	1 Conductor [mm²]	1...4								0.5...2.5							
		2 Conductor [mm²]	1...4								0.75...2.5							
	Solid/Stranded-Conductor	1 Conductor [mm²]	1.5...6								0.5...2.5							
		2 Conductor [mm²]	1.5...6								0.75...2.5							
Recommended Tightening Torque		[Nm]	1...2.5								1...1.5							
Max. Wire Size per UL/CSA		[AWG]	16...10								18...14							
Recommended Tightening Torque		[lb-in]	8.9...22								8.9...13.3							
<b>Degree of Protection</b>			IP2LX per IEC 529 and DIN 40 050															

**Mechanical Latch**

		CA5-AM5	CA5-AM6	CA5-AM7	
<b>Service Life</b>					
Mechanical	[Mil ops.]	0.5	0.5	0.5	
<b>Dropout Delay</b>					
Contact Latch	[ms]	50...70	50...70	50...70	
<b>Trip Coil</b>					
Consumption	AC	[VA]	950	1600	3500
	DC	[W]	500	800	3200
OFF-command (min. impulse duration)	[ms]	200	200	200	
<b>Operation Voltage</b>					
Minimum		$0.5 U_n$	$0.5 U_n$	$0.5 U_n$	
Maximum		$1.1 U_n$	$1.1 U_n$	$1.1 U_n$	

**Auxiliary Contacts**

**For CA5-700 & CA5-860 contactors**

Up to two auxiliary contact blocks can be mounted on each contactor. One four-pole auxiliary contact block (CA5-EF22) is supplied standard and is installed on the contactor between T1 and T2. One additional auxiliary contact block can be installed between T2 and T3.

Each CA5-EF22 contains 2 NO and 2 NC adjustable auxiliary contacts. Standard terminal markings are shown below on the left. If an additional contact block is required, different terminal markings (right) are supplied and may be applied by the user.

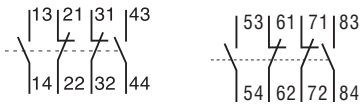

**Adjustable Auxiliary Contacts**

The instant at which the NO contact closes, in relation to the main contacts, can be adjusted from the front of the CA5-EF22 auxiliary contact block by means of an Allen wrench. The following diagrams show the adjustments for Normal, Delayed and Overlapping auxiliary contacts.

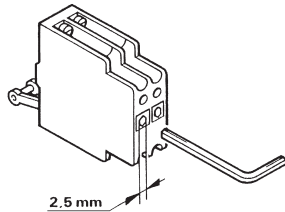

**Normal Setting (from factory)**

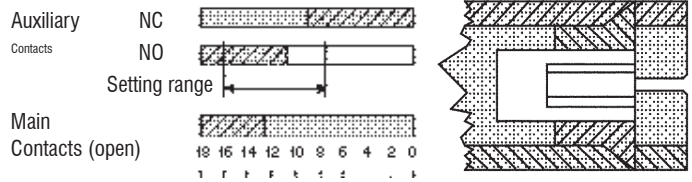

**Delayed NO Contact**

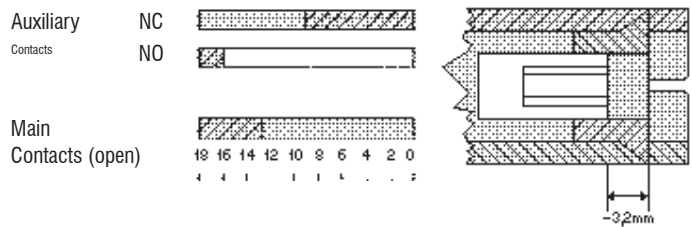

**Overlapping NO and NC Contacts**

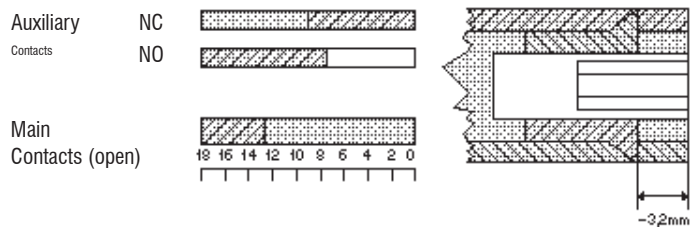

**For CA5-1000 and CA5-1200 contactors**

Up to four nonadjustable auxiliary contact blocks can be mounted on each contactor. One CA5-EB11 two pole aux contact and one CA5-EB11DC two pole aux contact come standard. The CA5-EB11DC has 1 NC contact (available) and 1 NO Delayed Make (unavailable) which is used for the operation of the coil feeder group.

- CA5-EB11      –      1 NO/1NC
- CA5-EB11DC –      1 NO Delayed Make/1 NC

**A**  
CA5 Contactors

Life-Load Curves

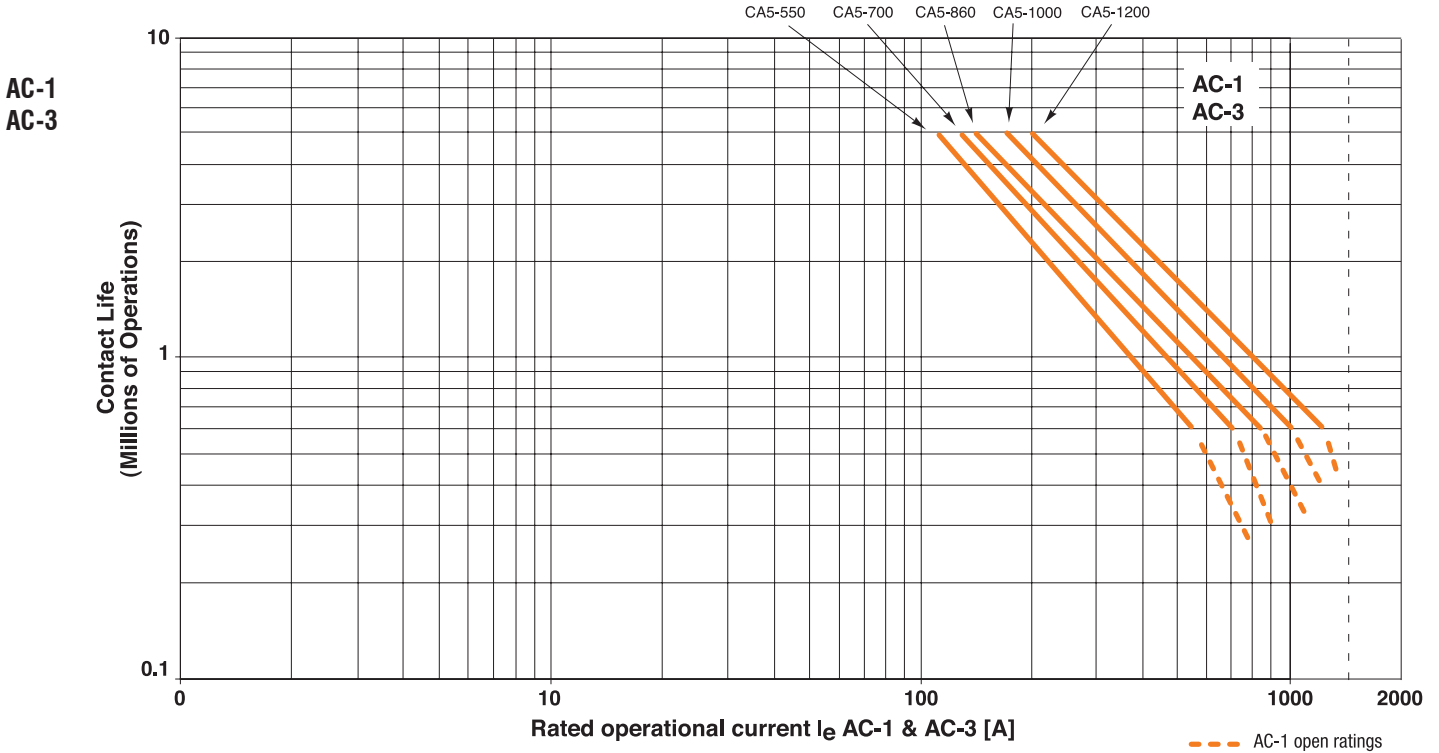

AC-1 - Non or slightly inductive loads, resistive furnaces;  $U_e=380...460$  VAC  
 AC-3 - Switching squirrel-cage induction motors during starting;  $U_e=380...460$  VAC

Instructions on  
**How to** read  
 Life Curves  
 can be found on page A8

**NOTE:** The life-load curves shown here are based on Sprecher+Schuh tests according to the requirements defined in IEC 947-4-1. Since contact life in any given application is dependent on environmental conditions and duty cycle, actual application contact life may vary from that indicated by the curves shown here.

Life-Load Curves

**A**  
CA5 Contactors

AC-4

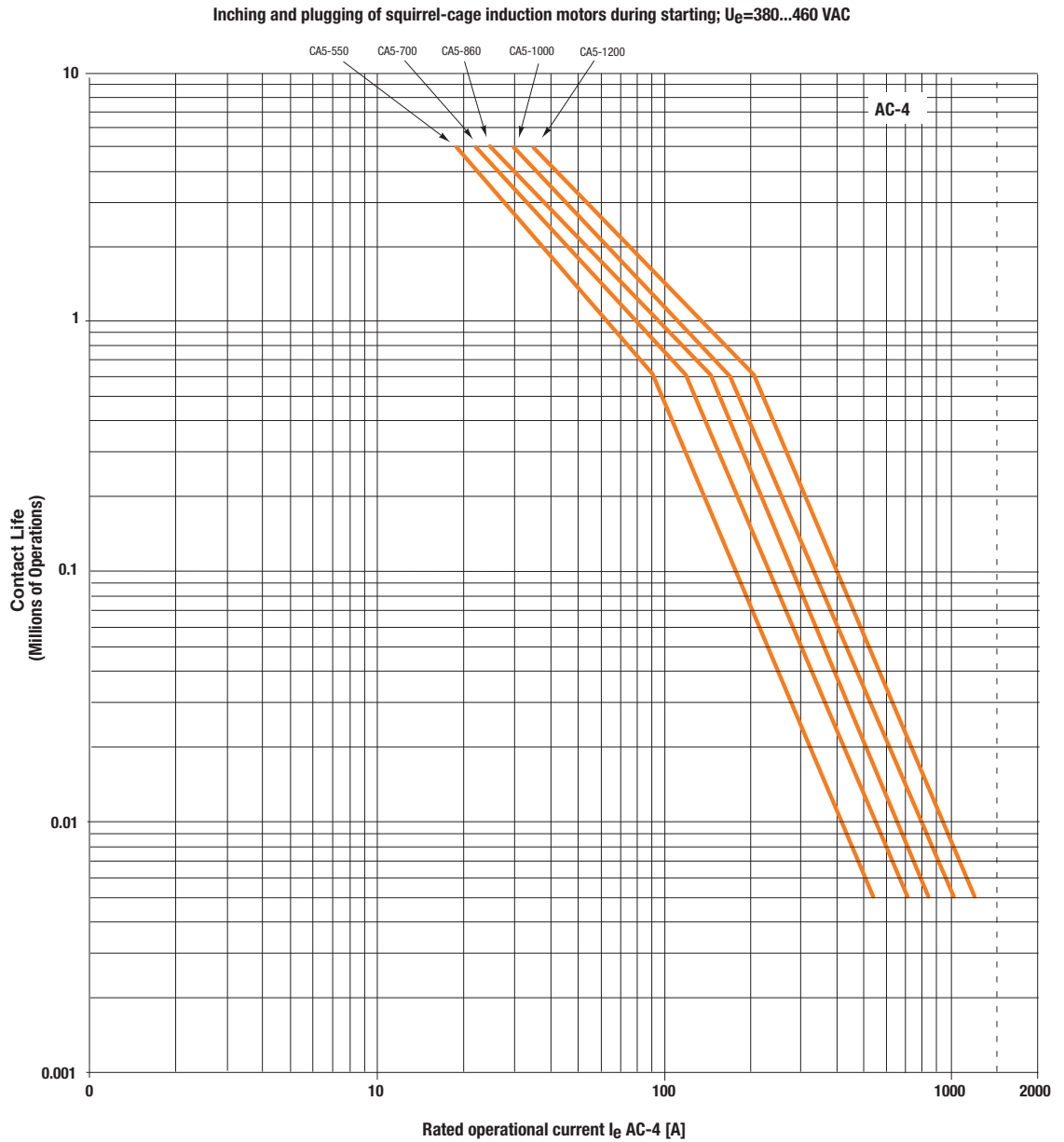

**NOTE:** The life-load curves shown here are based on Sprecher+Schuh tests according to the requirements defined in IEC 947-4-1. Since contact life in any given application is dependent on environmental conditions and duty cycle, actual application contact life may vary from that indicated by the curves shown here.

**A**

**Life-Load Curves**

CA5 Contactors

AC-3 (90%),  
AC-4 (10%)

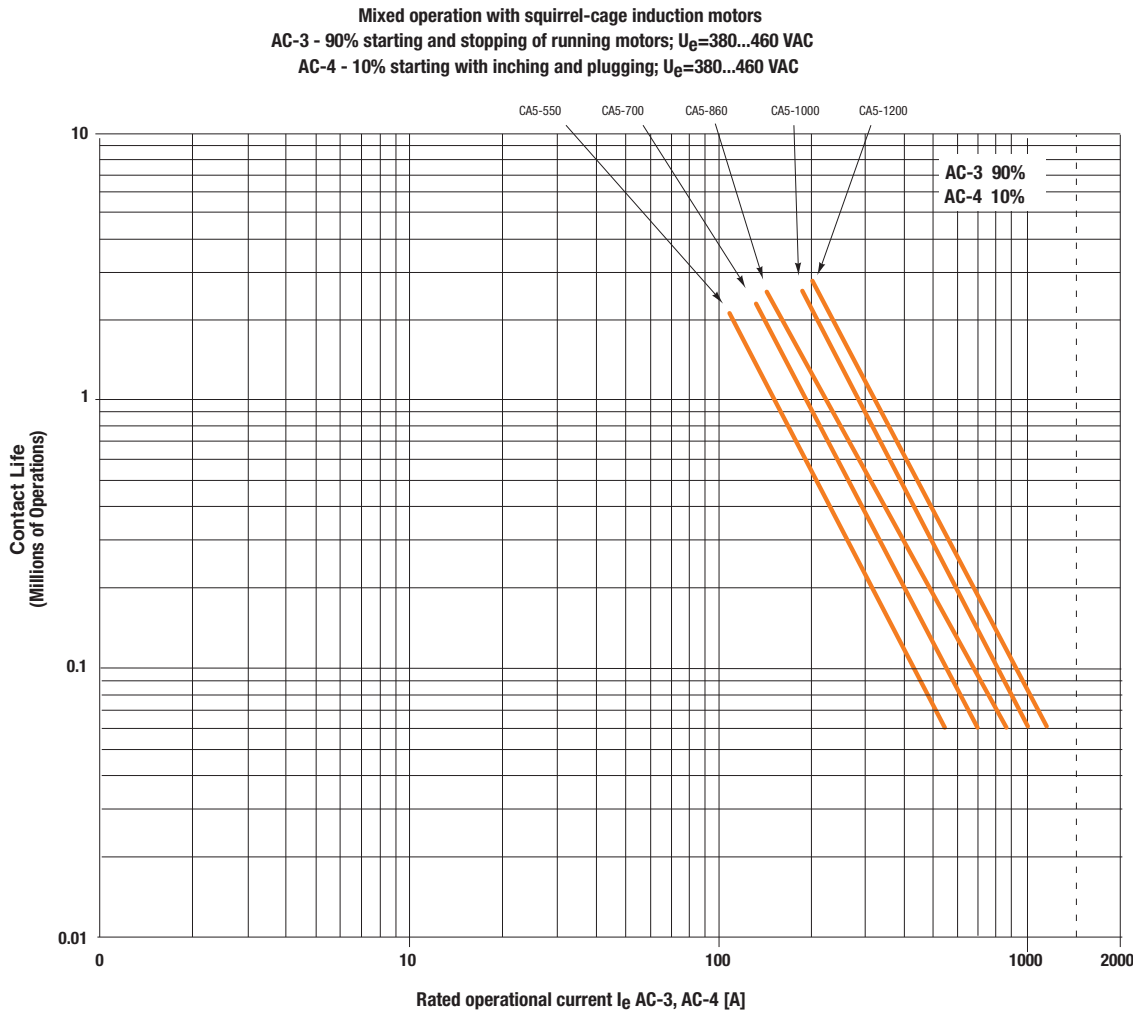

**Contact Life for Mixed Utilization Categories AC-3 and AC-4**

In many applications, the utilization category cannot be defined as either purely AC-3 or AC-4. In those applications, the electrical life of the contactor can be estimated with the following equation:

$$L_{mixed} = L_{ac3} / [1 + P_{ac4} \times (L_{ac3} / L_{ac4} - 1)], \text{ where:}$$

- $L_{mixed}$  Approximate contact life in operations for a mixed AC-3/AC-4 utilization category application.
- $L_{ac3}$  Approximate contact life in operations for a pure AC-3 utilization category (from the AC-3 life-load curve).
- $L_{ac4}$  Approximate contact life in operations for a pure AC-4 utilization category (from the AC-4 life-load curve).
- $P_{ac4}$  Percentage of AC-4 operations

**NOTE:** The life-load curves shown here are based on Sprecher+Schuh tests according to the requirements defined in IEC 947-4-1. Since contact life in any given application is dependent on environmental conditions and duty cycle, actual application contact life may vary from that indicated by the curves shown here.

Operating Rate Curves

AC-3

Starting and stopping of running motors  
Starting time  $t_A = 0.25$  s  
Relative time energized 40%

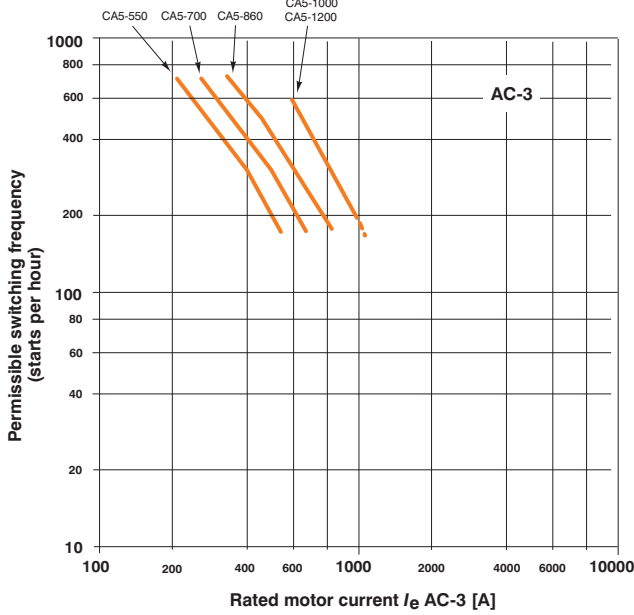

Starting time  $t_A = 1$  s

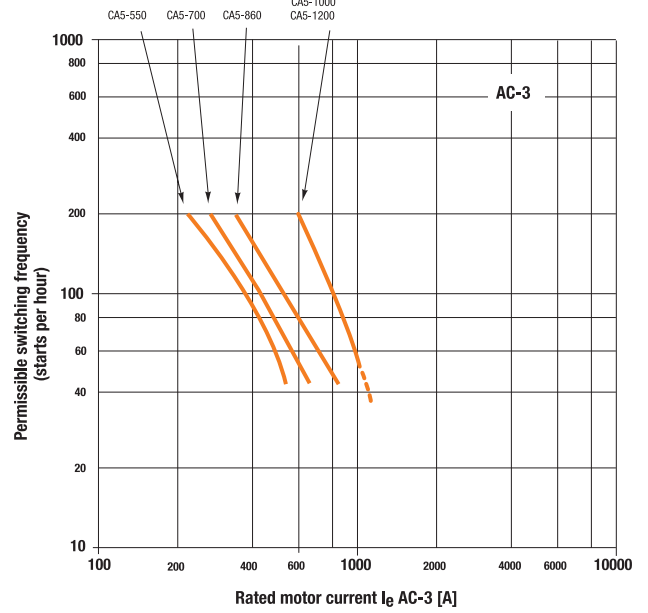

Switching motors during running (AC2, AC4)  
Time energized  $t_{ED} = 0.25$  s ( $< t_A$ )

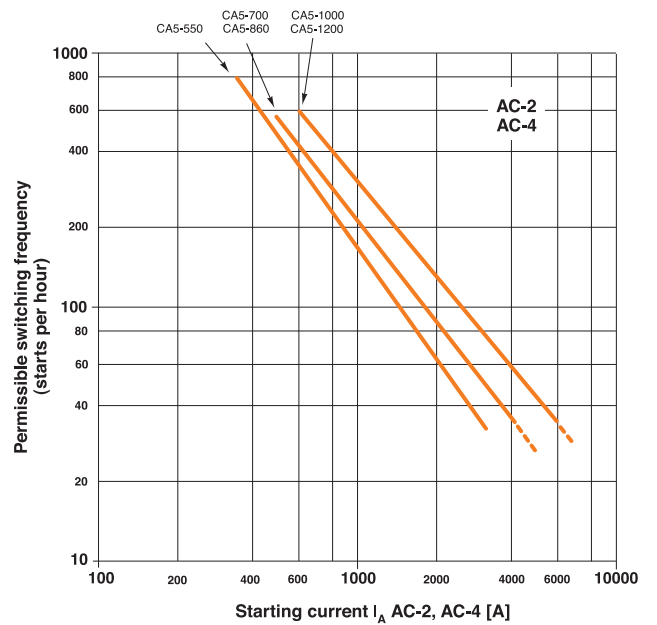



**Series CA5 & Series CAU5 (Contactors & Reversing Contactors)**

Dimensions are in millimeters (inches). Dimensions not intended for manufacturing purposes.

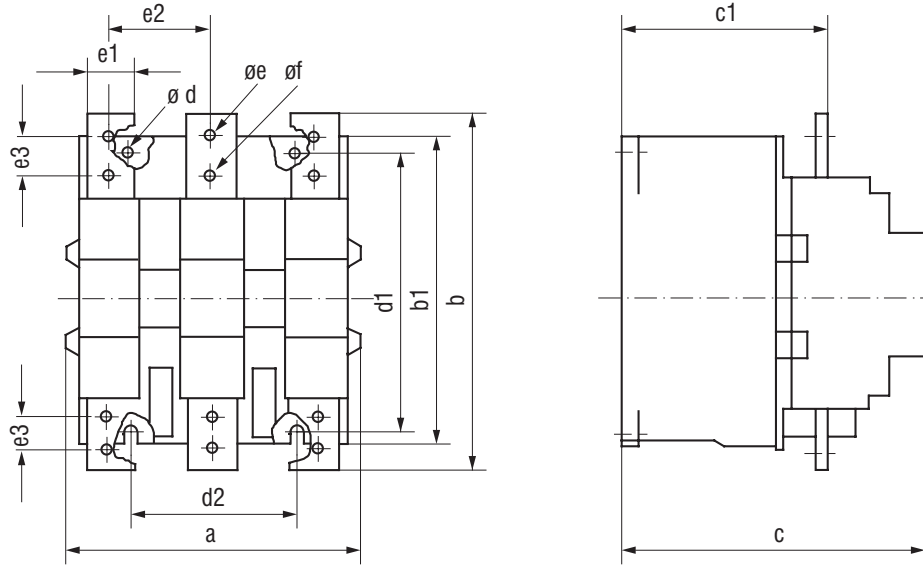

Type	a	b	b1	c	c1	ød	d1	d2	øe	øf	e1	e2	e3
CA5-550	220 (8-21/32)	258 (10-5/32)	228 (8-31/32)	225 (8-7/8)	164 (6-7/16)	9 (3/8)	220 (8-21/32)	110 (4-5/8)	13 (17/32)	-	40 (1-19/32)	79 (3-1/8)	-
CA5-700	280 (11-1/32)	307 (12-3/32)	277 (10-29/32)	291 (11-15/32)	203 (8)	11 (7/16)	280 (11-1/32)	175 (6-7/8)	13 (17/32)	-	50 (1-31/32)	101 (4)	-
CA5-860	280 (11-1/32)	361 (14-7/32)	325 (12-25/32)	291 (11-15/32)	203 (8)	11 (7/16)	280 (11-1/32)	175 (6-7/8)	15 (19/32)	11 (7/16)	50 (1-31/32)	101 (4)	32 (1-17/64)
CA5-1000	334 (13-5/32)	490 (19-9/32)	434 (17-1/16)	345 (13-9/16)	231 (9/32)	13 (25/64)	380 (14-31/32)	120 (4-23/32)	13 (25/64)	13 (25/64)	60 (2-3/8)	100 (3-31/32)	40 (1-9/16)
CA5-1200	334 (13-5/32)	490 (19-9/32)	434 (17-1/16)	345 (13-9/16)	231 (9/32)	13 (25/64)	380 (14-31/32)	120 (4-23/32)	13 (25/64)	13 (25/64)	60 (2-3/8)	100 (3-31/32)	40 (1-9/16)

**Reversing Contactors & Accessories**

Contactor with...	Dimension [mm]	Dimension [inches]
- auxiliary contact block	a	a
- reversing contactors with mechanical interlock		
next to each other		
CA 5-550-/CA 5-550	a+42+a	a+1-23/32+a
CA 5-700, -860/ CA 5-700, -860	a+32+a	a+1-1/4+a
CA 5-1000, -1200/ CA 5-1000, -1200	a+46+a	a+1-13/16+a
CA 5-550/CA, 5-700, -860	a+37+a	a+1-15/32+a
CA 5-700, -860/ CA 5-1000, -1200	a+73+a	a+2-7/8+a
above each other		
CA 5-550-/CA 5-550	b+56+b	b+2-3/16+b
CA 5-700, -860/ CA 5-700, -860	b+100...200+b	b+3-15/16...7-7/8+b
CA 5-1000, -1200/ CA 5-1000, -1200	b+230...280+b	b+9-1/16...11-1/32+b
CA 5-550/CA, 5-700, -860	b+100...200+b	b+3-15/16...7-7/8+b
CA 5-700, -860/ CA 5-1000, -1200	b+230...280+b	b+9-1/16...11-1/32+b
four main contacts		
CA 5-550-/CA 5-700, -860	a+68	a+2-11/16
CA 5-1000, -1200	a+76	a+3
latch		
CA 5-550	b+47	b+1-7/8
CA 5-700	b+64	b+2-17/32
CA 5-860	b+37	b+1-15/32
CA 5-1000, -1200	a+30	a+1-3/16

**Mounting Position**

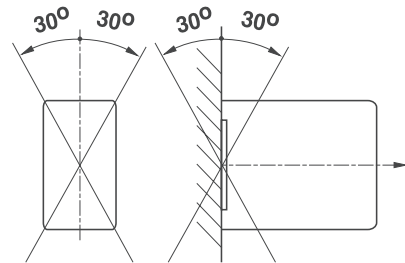



# Series CDP2 Definite Purpose Contactors

High performance economical contactors for commercial applications up to 90A



Sprecher + Schuh's Definite Purpose contactors are ideal for commercial applications including air conditioning, refrigeration, resistive heating and many other installations where a low cost, high performance contactor is needed. These devices offer flexibility and are designed to meet or exceed electrical and mechanical requirements as defined by definite purpose contactor standards.

## Popular sizes for most applications

The CDP2 series consists of one, two, three and four pole contactors rated to 600V AC. Three pole devices range up to 90A, while the one and two pole models are rated to 40A. Four pole contactors are also available ranging from 25A to 40A.

## Flexibility and convenience make installation easy

CDP2 contactors are compact in size and offer three convenient methods of wire connection: quick connect terminals, screws or box lugs. Box lugs are standard on 40A and larger contactors. Other models come standard with combination quick connect terminals and screws that accept hex, slotted or phillips screwdrivers.

## Standard Features

- Universal mounting plate
- 25A & 30A have screw power terminals that will accept ring-tongue terminals
- 40A and larger have box power terminals
- Dual quick-connect power terminals on all sizes
- Dual quick-connect coil terminals on all sizes
- Double break power contact design with feed-thru wiring
- Class B (130°C) coil insulation
- Double E magnet assembly

## Optional Features

- SPDT auxiliary contacts optional on 3- and 4-pole contactors (max of two)
- Optional covers for 1- and 2-pole contactors
- Mechanical interlock for 3-pole contactors

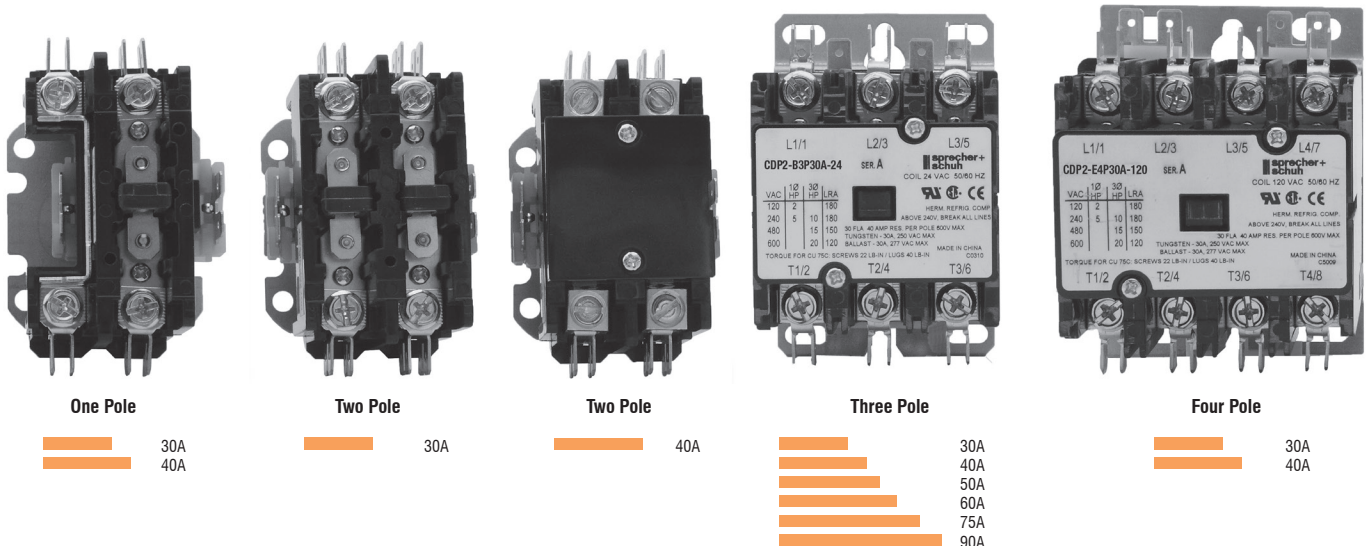

# Compare These Features

**Built-in Shock Absorber**  
Reduces contact bounce for longer life.

**Coil Dust Cover**  
Keeps dust and dirt away from magnet and coil area.

**Coil**  
Class B (1300 C Insulation System) with wide range of voltages and 50/60 Hz ratings. Includes shading coil that reduces contact chatter.

**Snap-on Auxiliary Contact**  
(optional on 3 and 4 pole contactors)  
One or two SPDT (shown) available.  
Also 1NO and 1NC with 600V AC rating.

**Base Assembly**  
High arc resistant polyester holds stationary terminals, positions actuator and magnet/coil assembly.

**Movable Contacts**  
Heavy duty silver cadmium oxide composition to resist welding and contact erosion for greater reliability

**Industry Standard Mounting Plate**  
Easily accessible mounting holes.

**Coil Terminals**  
#6 - 32 screw and one .250 Quick Connect or Dual .250 Quick Connects (will accept two insulated quick connect terminals).

**Double E Magnet Assembly**  
Provides optimal performance with reduced power consumption

**Stationary Terminal**  
One piece terminal design with integral dual .250 Quick Connects. Meets NEMA standard for spacing without insulated terminals.

**Actuator**  
Molded from high arc resistant polyester, holds upper magnet, movable contacts and contact springs position.



## Quick Selection Guide

One and Two Pole Definite Purpose Contactors with AC Coil - See page A152				
CDP2 ①	A	1P	30A	24
<b>Type</b>	<b>Frame Size</b>	<b>Poles</b>	<b>Amp Rating</b>	<b>Coil Voltage</b>
Definite Purpose	A = 30 & 40A	1P = 1 pole 2P = 2 pole	30A = 30 amps 40A = 40 amps	24 = 24 volts 120 = 120 volts 220W = 208-240 volts 277 = 277 volts

Three Pole Definite Purpose Contactors with AC Coil- See page A153				
CDP2 ①②	B	3P	30A	24
<b>Type</b>	<b>Frame Size</b>	<b>Poles</b>	<b>Amp Rating</b>	<b>Coil Voltage</b>
Definite Purpose	B = 30 & 40A C = 50 & 60A D = 75 & 90A	3P = 3 poles	30A = 30 amps 40A = 40 amps 50A = 50 amps 60A = 60 amps 75A = 75 amps 90A = 90 amps	24 = 24 volts 120 = 120 volts 220W = 208-240 volts 277 = 277 volts 480 = 480 volts

Four Pole Definite Purpose Contactors with AC Coil - See page A154				
CDP2 ①②	E	4P	25A	24
<b>Type</b>	<b>Frame Size</b>	<b>Poles</b>	<b>Amp Rating</b>	<b>Coil Voltage</b>
Definite Purpose	E = 25...40A	4P = 4 poles	25A = 25 amps 30A = 30 amps 40A = 40 amps	24 = 24 volts 120 = 120 volts 220W = 208-240 volts 277 = 277 volts 480 = 480 volts

- ① Screw power terminals standard on 30A. Box lug power terminals standard for 40A and larger.
- ② Box lugs on 30A available with volume special order only.

#### One and Two Pole Definite Purpose Contactors with AC Coil (Open type only) ④

Full Load Amps	Poles	Locked Rotor Amps			Resistive Amps ②	Maximum H.P.		Catalog Number	Std. Pkg.
		240V ②	480V	600V		1Ø			
						120V	240V ②		
30 ①	1 ⑥	150	75	50	40	1	2	CDP2-A1P30A-* ⑤	50
30 ①	2	150	125	100	40	2	3	CDP2-A2P30A-* ⑤	50
40	1 ⑥	200	150	120	50	2	3	CDP2-A1P40A-* ⑤	50
40	2	200	150	120	50	2	3	CDP2-A2P40A-* ⑤	50

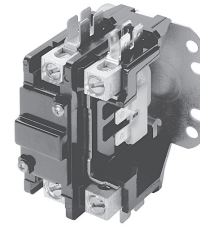

Series CDP2 1-pole contactor

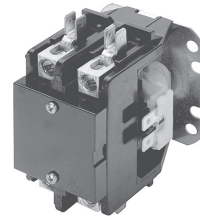

Series CDP2 2-pole contactor (with optional cover)

#### Accessories

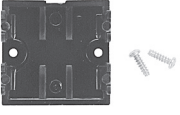
Accessory	Description	For use with...	Catalog Number
	<b>Contactor Cover</b> - Prevents foreign particles from entering contactor. Covers current carrying parts.	CDP2-A1P30A... CDP2-A2P30A...	<b>CDP2-A1P-C ⑦</b> <b>CDP2-A2P-C</b>

#### AC Coil Codes

AC Coil Code	Voltage Range
	60 Hz
24	24V
120	120V
220W	208-240V
277	277V

#### Ordering Instructions

Specify Catalog Number	
Replace (*) with Coil Code	<b>See Coil Codes on this page</b>

- ① 25A contactors only available by special order. Contact your Sprecher +Schuh representative.
- ② 240V rating also applies to 277V applications.
- ③ Box Power Lugs are supplied as standard. Screw terminals are available on the power connections by special order only in quantity.
- ④ 1 and 2 Pole, 25 and 30A contactors supplied without cover. See Accessories for cover options.
- ⑤ Screw Power Terminals are supplied standard on 25 and 30A contactors. Box Lugs available by special order only in quantity.
- ⑥ 1-Pole (1-pole plus) contactors include a shunt for termination and feed-thru of neutral.
- ⑦ 40 Amp contactors are supplied with cover as standard.

### Three Pole Definite Purpose Contactors with AC Coil (Open Type only)

Full Load Amps	Locked Rotor Amps			Resistive Amps ②	Maximum Horsepower ②						Catalog Number	Std. Pkg.	
					1Ø			3Ø					
	240V ②	480V	600V		120V	200	240V	200V	240V	480V			600V
30 ①	180	150	120	40	2	~	5	10	10	15	20	CDP2-B3P30A-* ④	25
40	240	200	160	50	3	~	7-1/2	10	10	20	25	CDP2-B3P40A-* ⑤	25
50	300	250	200	65	3	7-1/2	10	15	15	25	25	CDP2-C3P50A-*	15
60	360	300	240	75	5	7-1/2	10	25	25	30	30	CDP2-C3P60A-*	15
75	450	375	300	93	5	10	15	20	25	40	40	CDP2-D3P75A-*	1
90	540	450	360	120	7-1/2	15	20	25	30	50	50	CDP2-D3P90A-*	1

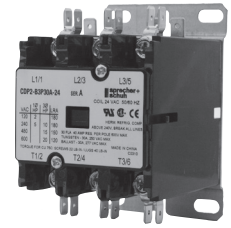

Series CDP2 3-pole contactor

### Auxiliary Contacts for 3 Pole Contactors ⑦

Auxiliary	Description	Circuit Diagram	Catalog Number
	<b>Two pole Auxiliary Contact Block (1-NO / 1-NC)</b> - Side mount with quick connect stabs  for 25...40A, 3 pole contactors for 50...90A, 3 pole contactors		<b>CDP2-BE-11 ⑥</b> <b>CDP2-CD-11 ⑥</b>
	<b>One pole Auxiliary Contact Block (SPDT)</b> - Side mount with quick connect stabs for 25...40A, 3 or 4 pole contactors		

### AC Coil Codes

AC Coil Code	Voltage Range
	60 Hz
24	24V
120	120V
220W	208-240V
277	277V
480	480V

### Ordering Instructions

Specify Catalog Number	
Replace (*) with Coil Code	See Coil Codes on this page

- ① 25A contactors available by special order. Contact your Sprecher + Schuh representative.
- ② 240V rating also applies to 277V applications.
- ③ Box lugs are supplied as standard. Screw terminals are available on the power connections by special order only in quantity.
- ④ Screw power terminals are supplied standard on 25 and 30A contactors. Box Lugs available by special order only in quantity.
- ⑤ Meets NEMA Standard B600. See page A7 for technical details.
- ⑥ Meets NEMA Standard B600 EXCEPT has 10 A continuous current rating.
- ⑦ A maximum of two auxiliary contacts can be installed on the contactor, one contact block on each side.

#### Four Pole Definite Purpose Contactors With AC Coil (Open Type only)

Full Load Amps	Locked Rotor Amps			Resistive Amps ②	Maximum Horsepower ③					Catalog Number	Std. Pkg.
					1Ø		3Ø				
	240V ④	480V	600V		120V	240V	200V	240V	480V		
30 ①	180	150	120	40	2	5	10	10	15	CDP2-E4P30A-* ⑤	20
40	240	200	160	50	3	7-1/2	10	10	20	CDP2-E4P40A-* ⑥	20

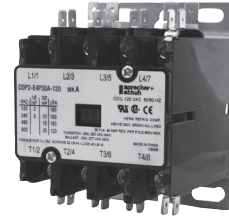

Series CDP2 4-pole contactor

#### Auxiliary Contacts for 4 Pole Contactors ⑥

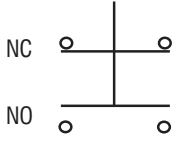
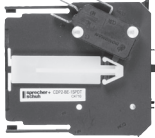
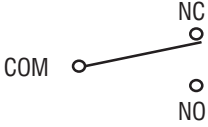
Auxiliary	Description	Circuit Diagram	Catalog Number
	<b>Two pole Auxiliary Contact Block (1-NO / 1-NC)</b> - Side mount with quick connect stabs for all 4 pole contactors		<b>CDP2-BE-11</b>
	<b>One pole Auxiliary Contact Block (SPDT)</b> - Side mount with quick connect stabs for all 4 pole contactors		<b>CDP2-BE-1SPDT</b>

#### A.C. Coil Codes

AC Coil Code	Voltage Range
	60 Hz
24	24V
120	120V
220W	208-240V
277	277V
480	480V

#### Ordering Instructions

Specify Catalog Number	
Replace (*) with Coil Code	See Coil Codes on this page

- ① 25A contactors available by special order. Contact your Sprecher + Schuh representative.
- ② 240V rating also applies to 277V applications.
- ③ Box Power Lugs are supplied as standard. Screw terminals are available on the power connections by special order only in quantity.
- ④ Screw per terminals are supplied standard on 25 and 30A contactors. Box Lugs available by special order only in quantity.
- ⑤ A maximum of two auxiliary contacts can be installed on the contactor, one contact block on each side.

**Definite Purpose Lighting Contactors with AC Coil (Open Type only)**

Tungsten Rating (Amps)	Ballast Rating (Amps)	Number of Poles	Standard Auxiliary Contacts		Electrically Held
			NO	NC	Open Type
					Catalog Number
30	40	1	0	0	<b>CDP2-A1P30A-*</b>
40	40	1	0	0	<b>CDP2-A1P40A-*</b>
30	40	2	0	0	<b>CDP2-A2P30A-*</b>
40	40	2	0	0	<b>CDP2-A2P40A-*</b>
30	40	3	0	0	<b>CDP2-B3P30A-*</b>
40	40	3	0	0	<b>CDP2-B3P40A-*</b>
30	40	4	0	0	<b>CDP2-E4P30A-*</b>
40	40	4	0	0	<b>CDP2-E4P40A-*</b>

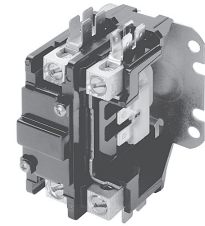

Series CDP2 1-pole contactor

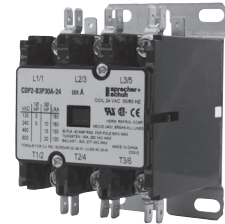

Series CDP2 3-pole contactor

**Description**

Sprecher + Schuh Definite Purpose contactors can be used to control a mixture of lighting loads. These contactors are well suited to handle the high inrush currents typical of this application as well as other non-motor (resistive) loads.

Lamps can basically be divided into three categories:

- Tungsten Filament Lamps
  - General purpose incandescent
  - Special purpose incandescent
  - Infrared
  - Sodium Iodine
- Discharge Lamps (with Ballast)
  - Fluorescent lamps - Mercury vapor
  - High/low pressure sodium
  - Quartz
  - Halogen metal-vapor
- Mixed Light Lamps

**In Application...**

The tungsten filaments of incandescent lamps have a very low ohmic resistance when cold. As a result, the closing current is very high but also very short. The closing current of discharge lamps (lighting with ballast) is highly inductive (due to series-connected transformers or chokes), and its duration depends on the lamp type.

**Electrically held contactors**

Electrically held contactors are available for use where the control signal is activated by a timer or other maintained electrical signal. The coil is energized as long as the contactor is closed. This design is well suited for applications where lights are operated frequently or where the control panel is in a remote location.

**AC Coil Codes**



AC Coil Code	Voltage Range
	60 Hz
<b>24</b>	24V
<b>120</b>	120V
<b>220W</b>	208-240V
<b>277</b>	277V
<b>480</b>	480V

**Ordering Instructions**

Specify Catalog Number	
Replace (*) with Coil Code	<b>See Coil Codes on this page</b>

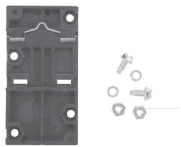

**Accessories**

Auxiliary	Description	For use with...	Catalog Number
	<p><b>DIN-rail Adaptor</b> - Attaches to the universal mounting plate of 1-, 2-, 3- and 4-pole contactors 25...40 Amps.</p>	<p>CDP2-A1P...B3P CDP2-E4P</p>	<p><b>CDP2-DRA</b></p>
	<p><b>Mechanical Interlock</b> - Can be combined with electrical interlocks on 3-pole and 4-pole contactors as required.</p>	<p>CDP2-B3P CDP2-E4P</p>	<p><b>CDP2-MK1</b></p>

**Short-Circuit Coordination**

		25-30A 1+2-Pole	40A 1+2-Pole	25-30A 3-Pole	40A 3-Pole	50-90A 3-Pole	25-30A 4-Pole	40A 4-Pole
<b>Standard Short Circuit Rating</b>	[kA]	5	5	5	5	5	5	5
<b>High Current Short Circuit Rating</b>								
Class J-fuses								
Available fault current	[kA]	100	100	100	100	❶	100	100
cUL Max. fuse (600V)	[A]	60	100	60	100	❶	50	100
Enclosure Minimum	[in <sup>3</sup> ]	96	96	144	144	❶	144	144
Molded Case Circuit Breaker								
Available fault current	[kA]	100	100	100	100	❶	100	100
cUL Max. breaker (480V)	[A]	80	80	80	100	❶	80	100
Enclosure Minimum	[in <sup>3</sup> ]	144	144	144	144	❶	144	144

**Service Life**

<b>Mechanical</b> (operations)	1,000,000	1,000,000	1,000,000	1,000,000	500,000	1,000,000	1,000,000	
<b>Electrical</b> (operations)								
Resistive Load (UL)	250,000	250,000	250,000	250,000	250,000	250,000	250,000	
Inductive Load (UL)	100,000	100,000	100,000	100,000	100,000	100,000	100,000	
Inductive Load (Self-certified)	200,000	200,000	200,000	200,000	200,000	200,000	200,000	

**Data for Surge Suppression Selection**

Contactor Configuration (All voltages)	Resistor	Capacitor	Snubber ❷
1 Pole	680 ohms	0.47 n <i>f</i>	RCS1M-6
2 Pole	330 ohms	0.47 n <i>f</i>	RCS1K-6
3P 30/40 Amp	220 ohms	0.47 n <i>f</i>	RCS1A-6
4P 30 Amp	220 ohms	0.47 n <i>f</i>	RCS1A-6
3P 50/60 Amp	150 ohms	0.47 n <i>f</i>	RCS1H-6
3P 75/90 Amp	68 ohms	0.47 u <i>f</i>	RCS1E-6

❶ UL testing not complete at the time of this printing.

❷ Recommended snubbers from RK Electric.

#### General Specifications

		CDP2	CDP2	CDP2	CDP2	CDP2
<b>Approvals</b>		<b>25...40A, 1 &amp; 2 pole</b>	<b>25...40A, 3 pole</b>	<b>50...60A, 3 pole</b>	<b>75...90A, 3 pole</b>	<b>25...40A, 4 pole</b>
UL		UL508, Guide No. NLDX2-File No. E3125				
CSA		C22.2 No. 14, Class; 321104-File No. 210566 (75A, 3 pole / C22.2 No. 14, Class: 122201 - File No. 210566)				
CE / SEMKO		Certified EN60947-4-1: 2010				
IEC		IEC 947-4-1 (Except 50A...90A, 3 pole)				
<b>Line and Load Terminals</b>		#10 - 32 screw or box lug	#10 - 32 screw or box lug	Box lug	Box lug	#10 - 32 screw or box lug
<b>Wire Size (min/max)</b>						
#10 - 32 screw (all 25A & 30A)	[AWG]	16 - 8 ①	16 - 8 ①	~	~	16 - 8 ①
Box Lug (≥40A)	[AWG]	14 - 4 Cu/Al	14 - 4 Cu/Al	14 - 2 Cu/Al	14 - 1/0 Cu/Al	14 - 4 Cu/Al
<b>Recommended Tightening Torque</b>						
#10 - 32 screw (all 25A & 30A devices)		22 lbs-in	22 lbs-in	~	~	22 lbs-in
Box Lug (40A devices only)		40 lbs-in	40 lbs-in	50 lbs-in	50 lbs-in	40 lbs-in
<b>Quick Connects</b>						
Coil Terminals		Dual .250 QC (2)	Quad .250 QC (2)	#6-32 screw 7 .250 QC (2)	#6-32 screw 7 .250 QC (2)	Dual .250 QC (2)
Power Terminals		1 pole: Quad .250 QC 2 pole: Quad .250 QC	Dual .250 QC (2)	Dual .250 QC (2)	Dual .250 QC (2)	Dual .250 QC (2)
<b>Arc Cover</b>		Optional	Standard	Standard	Standard	Standard
<b>Insulation System</b>		130°C Class B				
<b>Temperature Range</b>		[°C]		-40°C to +65°C		
		[°F]		-40°F to +150°F		
<b>Weight</b>		1 pole 0.5 lb 2 pole: 0.6 lb	1 lb	2 lbs	4 lbs	1.5 lbs.
<b>UL/CSA Ratings for 25A special order contactors</b>		<b>1 Pole</b>	<b>2 Pole</b>	<b>3 Pole</b>		
Locked Rotor Amps	240/277 V [A]	150	150	150		
	480V [A]	125	125	125		
	600V [A]	100	100	100		
Resistive Amps	[A]	35	35	35		
Max. HP	1∅	120 V [HP]	2	2	2	
		240 V [HP]	3	3	3	
	3∅	200 V [HP]	~	~	7.5	
		230 V [HP]	~	~	7.5	
		460 V [HP]	~	~	10	
		575 V [HP]	~	~	10	
<b>Coil Data</b>						
<b>1 Pole Contactors (25...40A)</b>		<b>24V Coils</b>	<b>120V Coils</b>	<b>220W Coils</b>	<b>277V Coils</b>	<b>480V Coils</b>
Normal Coil Voltage	[V]	24	120	208 / 240	277	~
Pickup voltage (min.)	[V]	18	88	177	221	~
Drop-out/Voltage Range	[V]	6...15	20...70	40...140	50...165	~
Nominal Inrush						~
50 Hz	[VA]	22.5	22.5	22.5	22.5	~
60Hz	[VA]	20	20	20	20	~
Nominal Seal-in						~
50 Hz	[VA]	7	7	7	7	~
60 Hz	[VA]	5.25	5.25	5.25	5.25	~
Nominal DC Resistance	[Ω]	16.5	420	1850	2650	~
<b>2 Pole Contactors (25...40A)</b>						~
Normal Coil Voltage	[V]	24	120	208 / 240	277	~
Pickup voltage (min.)	[V]	18	88	177	221	~
Drop-out Voltage Range	[V]	6...15	20...70	40...140	50...165	~
Nominal Inrush						~
50 Hz	[VA]	37	37	37	37	~
60Hz	[VA]	35	35	35	35	~
Nominal Seal-in						~
50 Hz	[VA]	8	8	8	8	~
60 Hz	[VA]	7	7	7	7	~
Nominal DC Resistance	[Ω]	11	250	1000	1600	~

① Stranding must be split for #8 wire.

<b>Coil Data (continued)</b>		<b>50/60 Hz 24V Coils</b>	<b>110 - 50 Hz 120 - 60 Hz 120V Coils</b>	<b>220 - 50 Hz 208-240 - 60 Hz 220W Coils</b>	<b>277 - 60 Hz 277V Coils</b>	<b>440 - 50 Hz 480 - 60 Hz 480V Coils</b>
<b>3 Pole Contactors (25...40A)</b>						
Nominal Coil Voltage	[V]	24	120	208-240	277	480
Pickup Voltage (min.)	[V]	18	88	177	220	384
Drop-out Voltage Range	[V]	6...15	20...70	40...140	50...165	150...270
Nominal Inrush						
50 Hz	[VA]	65	65	65	65	65
60Hz	[VA]	60	60	60	60	53
Nominal Seal-in						
50 Hz	[VA]	7.5	7.5	7.5	7.5	7.5
60 Hz	[VA]	6	6	6	6	6
Nominal DC Resistance	[Ω]	7	180	720	950	3100
<b>3 Pole Contactors (50...40A)</b>						
Nominal Coil Voltage	[V]	24	120	208-240	277	480
Pickup Voltage (min.)	[V]	18	88	177	221	374
Drop-out Voltage Range	[V]	6...15	20...70	40...140	65...185	120...286
Nominal Inrush						
50 Hz	[VA]	114	108	126	120	98
60Hz	[VA]	105	105	125	115	108
Nominal Seal-in						
50 Hz	[VA]	13	12	14	13	10
60 Hz	[VA]	12	11	13	1	10
Nominal DC Resistance	[Ω]	4	52	282	453	1390
<b>3 Pole Contactors (75...90A)</b>						
Nominal Coil Voltage	[V]	24	120	208-240	277	480
Pickup Voltage (min.)	[V]	22	95	177	235	384
Drop-out Voltage Range	[V]	6...15	20...70	40...110	65...185	150...270
Nominal Inrush	[Ω]					
50 Hz	[VA]	225	225	280	210	210
60Hz	[VA]	222	220	270	202	202
Nominal Seal-in						
50 Hz	[VA]	22	19	27	27	19
60 Hz	[VA]	21	18	25	25	18
Nominal DC Resistance	[Ω]	.66	15.8	50	93	258
<b>4 Pole Contactors (25...40A)</b>						
Nominal Coil Voltage	[V]	24	120	208-240	277	480
Pickup voltage (min.)	[V]	18	88	177	220	384
Drop-out Voltage Range	[V]	6...15	20...70	40...140	65...185	15...270
Nominal Inrush						
50 Hz	[VA]	62	62	62	62	67
60 Hz	[VA]	59	59	59	59	60
Nominal Seal-in						
50 Hz	[VA]	9	9	9	8	9
60 Hz	[VA]	7	7	7	6.5	7
Nominal DC Resistance	[Ω]	6	150	600	750	2400
<b>Operating Times</b>						
AC: 50Hz, 60hz						
Pick-up [ms]		0...20	0...20	0...20	0...20	0...20
Drop-out [ms]		0...30	0...30	0...30	0...30	0...30

### Auxiliary Contacts

#### 2 Pole (NO/NC) - Single Circuit Contact Rating

Voltage Rating	120	240	480	600	
Amperes	Break	3.0	1.5	0.75	0.6
	Make	30	15	7.5	6
	Continuous	10	10	10	10

#### SPDT

10A, 1/3 HP, 125 or 250V AC; 1/2A, 125 V DC; 1/4A, 250V DC; 4A, 120V AC on Lamp Load

**A**

**CDP2 Contactors**

**CDP2 25...40A, 1 & 2 Pole**

Dimensions are in inches (millimeters). Dimensions not intended for manufacturing purposes.

**1-Pole**

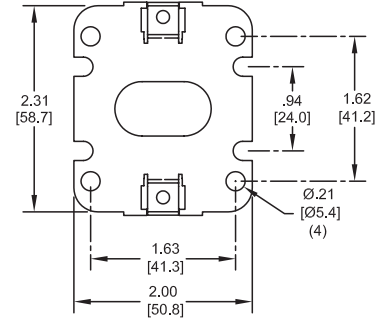
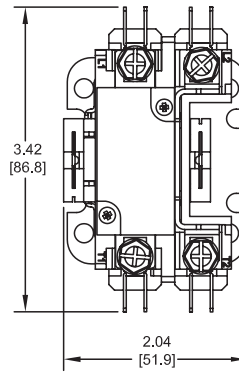
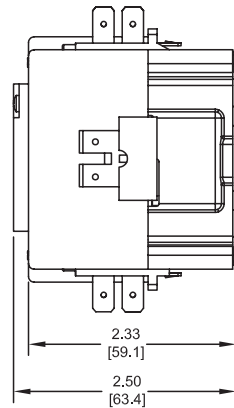

**2-Pole**

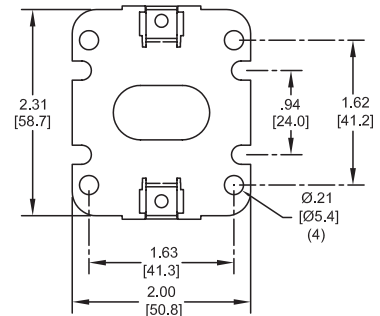
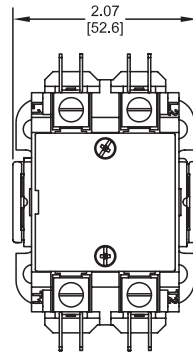
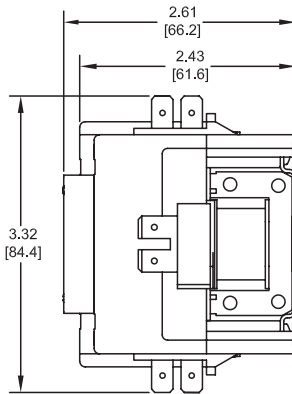

**CDP2 25...40A, 3 Pole with Auxiliary**

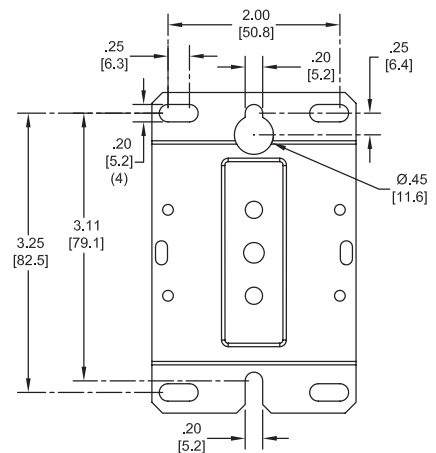
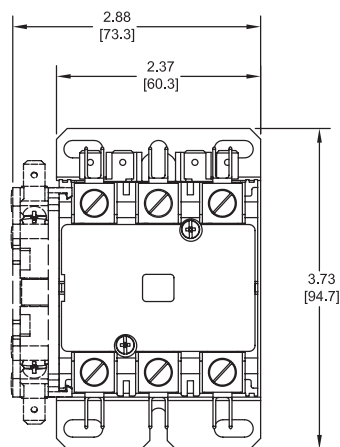
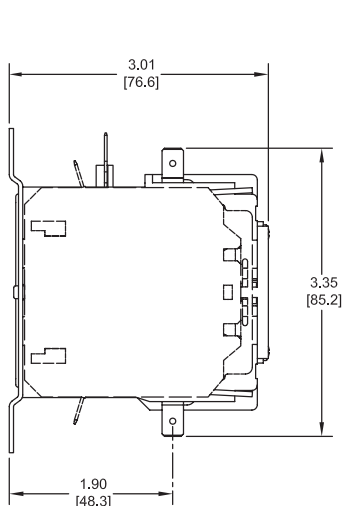

**CDP2 50...60A, 3 Pole with Auxiliary**

Dimensions are in inches (millimeters). Dimensions not intended for manufacturing purposes.

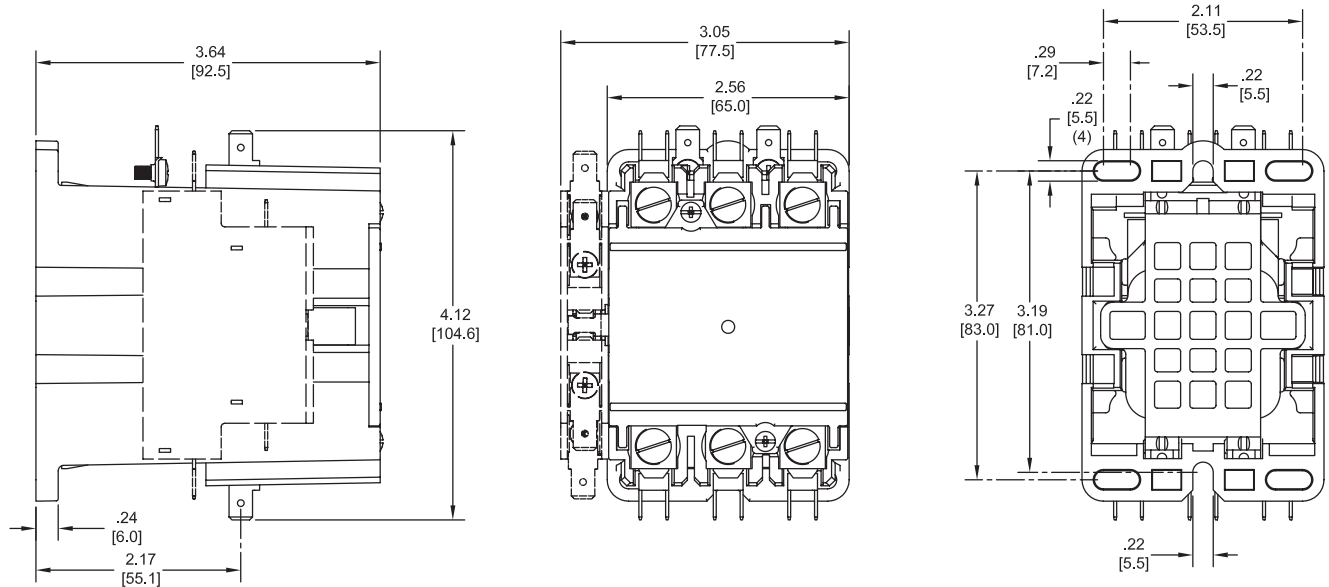

**CDP2 75...90A, 3 Pole with Auxiliary**

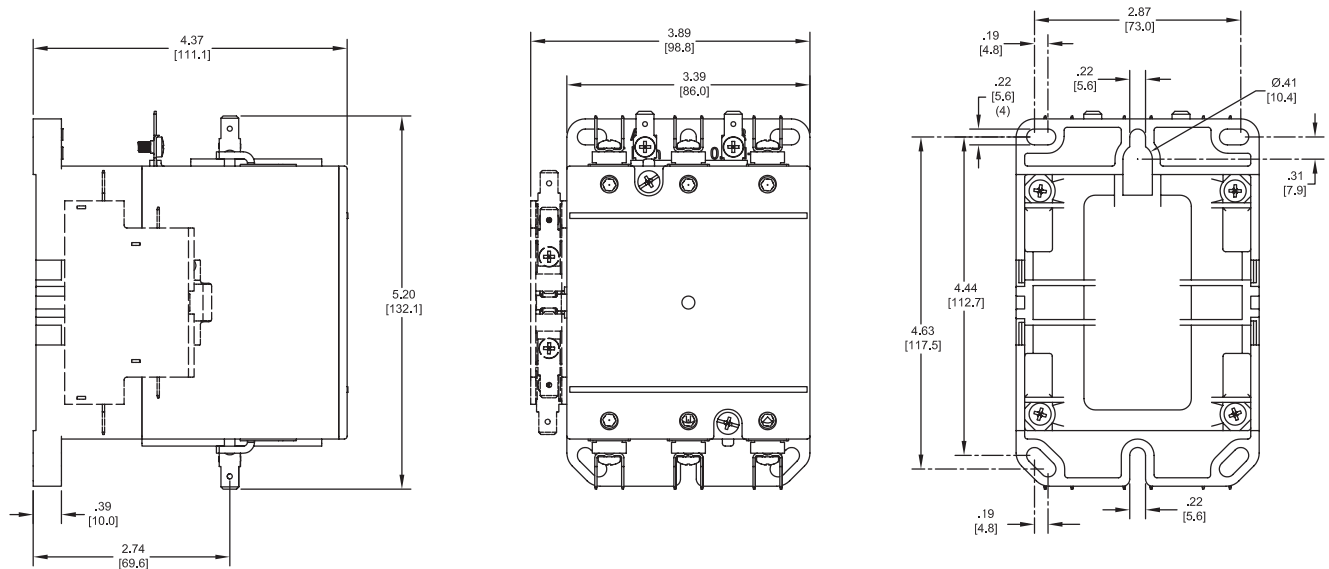

**CDP2 25...40A, 4 Pole with Auxiliary**

Dimensions are in inches (millimeters). Dimensions not intended for manufacturing purposes.

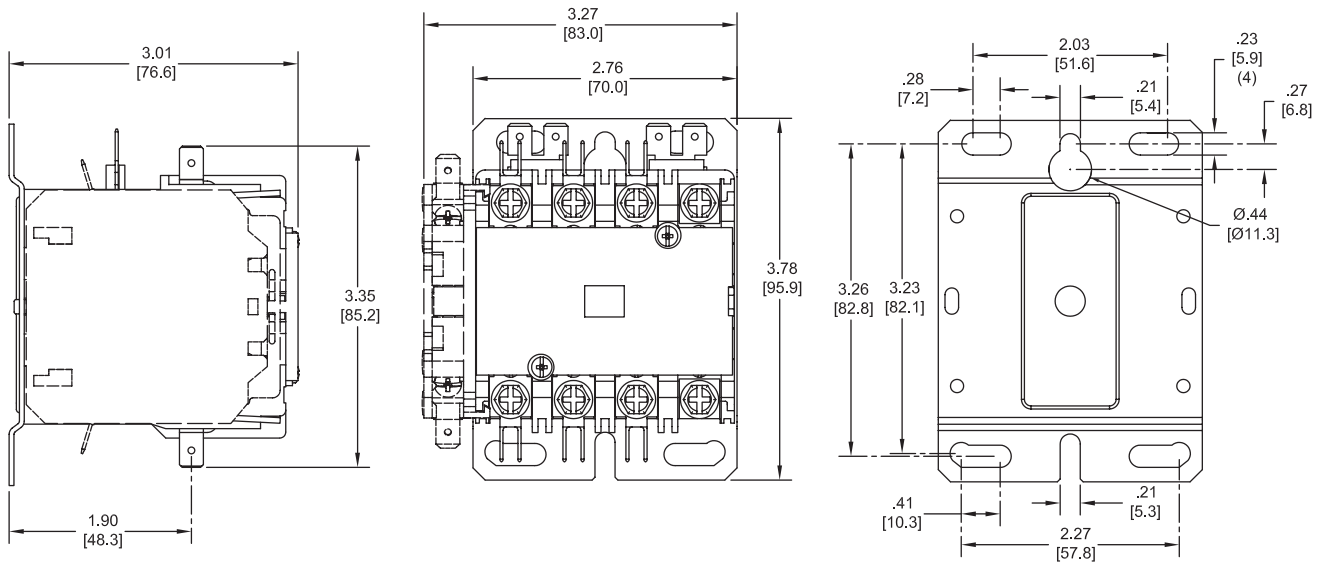

**CDP2-MK1 Mechanical Interlock**

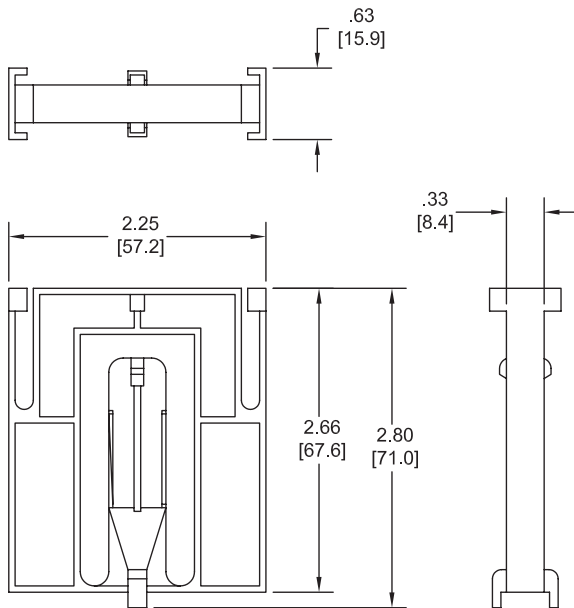

**Terminations**

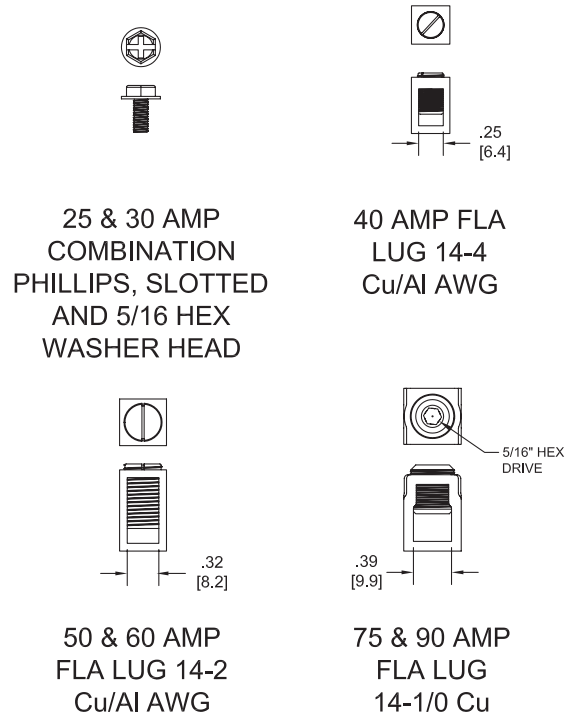







**A**

*Contactors*

**Notes**

*For Technical Information and Dimensions  
please see the online catalog*



**A**

*Contactors*

**Notes**

*For Technical Information and Dimensions  
please see the online catalog*







Notes

*For Technical Information and Dimensions  
please see the online catalog*







