































Top (Front) Mount Auxiliary Contact Blocks ①

Contact Block	Description	NO	NC	Contact Arrangement	For use with...	Standard Contacts Catalog Number	Bifurcated Contacts Catalog Number ②
 <p>Top mount auxiliary contact blocks snap-on to the top (front) of any CA7 contactor</p>	<p>Auxiliary Contact Blocks for Top Mounting -</p> <ul style="list-style-type: none"> • 2 and 4 pole • Snap on design - mounts without tools • Electronic compatible contacts • Mutual positive guidance to the main contactor poles (excluding L types) • Several terminal numbering choices even for models wit equal function • Late break /early make (L) available <p>Bifurcated Contacts</p> <p>Bifurcated auxiliary contacts provides a higher degree of reliability than the standard cross-stamped auxiliary contacts because it H-bridge divides each movable contact into two sections at the tip of the spanner. Typical application is low-voltage low-current applications (i.e.: PLC). Cross-stamped contacts are good for a minimum of 5mA at 17v while bifurcated contacts are good for a minimum of 3mA at 5v.</p>	0	2		CA7 all	CS7-PV-02	CS7-PVB-02
		0	2		CA7-30...97-*-00	CA7-PV-02	CA7-PVB-02
1		1		CA7 all	CS7-PV-11	CS7-PVB-11	
1		1		CA7-30...97-*-00	CA7-PV-11	CA7-PVB-11	
2		0		CA7 all	CS7-PV-20	CS7-PVB-20	
2		0		CA7-30...97-*-00	CA7-PV-20	CA7-PVB-20	
1EM		1LB		CA7-30...97-*-00	CA7-PV-L11	NOT AVAILABLE	
1		3		CA7-30...97-*-00	NOT AVAILABLE	CA7-PVB-13	
2		2		CA7 all	CS7-PV-22	CS7-PVB-22	
2		2		CA7-30...97-*-00	CA7-PV-22	CA7-PVB-22	
2		2		CA7-9...23-*-10 CA7-9...23-*-01	CA7-PV-S22	CA7-PVB-S22	
3		1		CA7 all	CS7-PV-31	CS7-PVB-31	
3	1		CA7-9...23-*-10 CA7-9...23-*-01	CA7-PV-S31	CA7-PVB-S31		
1	3		CA7 all	CS7-PV-13	CS7-PVB-13		
4	0		CA7 all	CS7-PV-40	CS7-PVB-40		
0	4		CA7 all	CS7-PV-04	CS7-PVB-04		
1+1EM	1+1LB		CA7 all	CS7-PV-L22	NOT AVAILABLE		

① Max. number of auxiliary contacts that may be mounted:
 • AC Coil and Electronic DC Coil contactors - max. 4 N.O. contacts on the front of the contactor, 2-N.O. contacts on the side, 4-N.C. front or side: 6 total.
 • True DC Coil contactors - max. 4 N.O. contacts on the front of the contactor, or max. 2-N.O. contacts on side, 4-N.C. front or side: 4 total.
 ② Detailed ratings can be found on page A75.



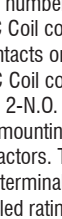



A Side Mount Auxiliary Contact Blocks (1 & 2 Pole) ①

CA7 Contactors

Contact Block	Description	NO	NC	Contact Arrangement	For use with...	Catalog Number ③
 1-pole (typical)	Auxiliary Contact Blocks for Side Mounting - ① <ul style="list-style-type: none"> • 1 and 2-pole • Two way numbering for right or left mounting on the contactor • Snap-on design - mounts without tools • Electronic compatible contacts down to 24V, 20mA • Late break / early make (L) available • Mutual positive guidance to the main contactor poles (excluding L-types) 	0	1		CA7 all	CA7-PA-01
 1-pole (typical)		1	0		CA7 all ②	CA7-PA-10
 2-pole (typical)		0	2		CA7 all	CA7-PA-02
 2-pole (typical)		1	1		CA7 all ②	CA7-PA-11
 2-pole (typical)		2	0		CA7 all ②	CA7-PA-20
 2-pole (typical)		1EM	1LB		CA7 all	CA7-PA-L11

- ① Max. number of auxiliary contacts that may be mounted:
 - AC Coil contactors - max. 4 N.O. contacts on the front of the contactor, 2-N.O. contacts on the side, 4-N.C. front or side: 6 total.
 - DC Coil contactors - max. 4 N.O. contacts on the front of the contactor, or max. 2-N.O. contacts on side, 4-N.C. front or side: (4) total.
- ② Left mounting only is recommended when using with CA7-9...CA7-23 contactors. These contactors have built-in auxiliaries, which will result in duplicate terminal markings if mounted on the right.
- ③ Detailed ratings can be found on page A75.

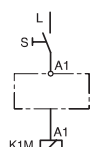
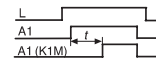
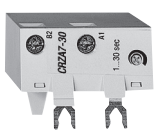
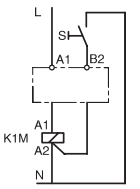
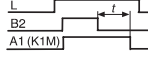
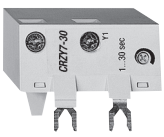
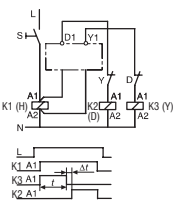
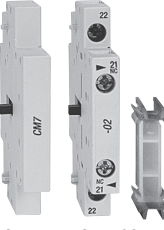
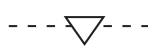
Control Modules ①

Module	Description	For use with. . .	Connection Diagrams	Function	Catalog Number
	<p>Pneumatic Timing Module – The contacts in the Pneumatic Timing Element switch after the delay time. The contacts on the main contactor continue to operate without delay.</p> <ul style="list-style-type: none"> • Continuous adjustment range 	CA7 with AC or 24V DC electronic coil		<p>ON-Delay 0.3...30s 1.8...180s</p>	<p>CZE7-30 CZE7-180</p>
		CA7 all		<p>OFF-Delay 0.3...30s 1.8...180s</p>	<p>CZA7-30 CZA7-180</p>
	<p>Electronic Timing Module – ② ON-Delay The contactor is energized at the end of the delay time.</p>	CA7 with 110...240V, 50/60Hz or 110...250V DC		<p>110...240V 50/60Hz 110...250V DC</p> <p>0.1...3s 1...30s 10...180s</p>	<p>CRZE7-3-110/240 CRZE7-30-110/240 CRZE7-180-110/240</p>
		CA7 with 24...48V DC		<p>24...48V DC</p> <p>0.1...3s 1...30s 10...180s</p>	<p>CRZE7-3-24/48VDC CRZE7-30-24/48VDC CRZE7-180-24/48VDC</p>
	<p>Electronic Timing Module – ② OFF-Delay After interruption of the control signal, the contactor is de-energized at the end of the delay time.</p>	CA7-9...37 with 110...240V, 50/60Hz		<p>110...240V 50/60Hz</p> <p>0.3...3s 1...30s 10...180s</p>	<p>CRZA7-3-110/240 CRZA7-30-110/240 CRZA7-180-110/240</p>
		CA7-9...37 with 24V, 50/60Hz		<p>24V AC 50/60Hz</p> <p>0.3...3s 1...30s 10...180s</p>	<p>CRZA7-3-24VAC CRZA7-30-24VAC CRZA7-180-24VAC</p>
	<p>Electronic Timing Module – ② Wye-Delta Transition Timer Contactor K3 (Y) is de-energized and contactor K2 (D) is energized after the end of the set transition time. Switching delay at 50ms.</p> <ul style="list-style-type: none"> • Continuous adjustment range • High repeat accuracy 	CA7 with 110...240V, 50/60Hz		<p>110...240V 50/60Hz</p> <p>1...30s</p>	<p>CRZY7-30-110/240</p>
 <p>CM7 CM7-02</p>	<p>Mechanical/Electrical Interlocks –</p> <ul style="list-style-type: none"> • Common to all CA7 contactors; • interlocks different contactor sizes • Mechanical and electrical interlocking possible in one module by means of integrated auxiliary contacts • Dovetail (CA7-S9) connector included (9mm) 	CA7 all ①		<p>Mechanical Without auxiliaries</p>	<p>CM7</p>
				<p>Mechanical/ Electrical Two NC aux contacts</p>	<p>CM7-02</p>

① Not for use with CA7-40 or CA7-90 (4-pole) contactors.
② Not available for use on CA7-9E...55E coil voltage 48V...220V.

Control Modules (continued)

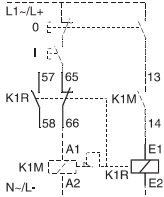
Module	Description	For use with...	Connection Diagrams	Catalog Number
	<p>Mechanical Latch – Following contactor latching, the contactor coil is immediately de-energized by the NC auxiliary contact (65-66).</p> <ul style="list-style-type: none"> • Electrical or manual release • 1 NO + 1 NC auxiliary switch • Suitable for all CA7 contactors 	All CA7 ⑥		<p>CV7-11-* Replace * with coil code below (See Application Note below)</p>

CV7 Mechanical Latch Coil Codes ①②④⑤

Coil Code	Application Range			Latch & Contactor Coil Rating
	50 Hz	60 Hz	VDC	
24Z	24 VAC	24 VAC	12 VDC	24V 50/60 Hz
48Z	48 VAC	48 VAC	24 VDC	48V 50/60 Hz
110	100 VAC	110 VAC	48 or 60VDC	110V50/110V60
120	110 VAC	120 VAC	~	110V50/120V60
220W	~	208...240 VAC	~	208...240V60
230Z	230 VAC	230 VAC	110 VDC	230V 50/60 Hz
240Z	240 VAC	240 VAC	125 VDC	240V 50/60 Hz
277	240 VAC	277 VAC	~	240V50/277V60
380	380...400 VAC	440 VAC	~	380...400V50/440V60
400Z	400 VAC	400 VAC	220 VDC	400V 50/60 Hz
415	400...415 VAC	~	~	400...415 V50 Hz
480	440 VAC	480 VAC	~	440V50/480V60
600 ③	550 VAC	600 VAC	~	550V50/600V60

APPLICATION NOTE:

The CV7 Mechanical Latch for CA7 may be used for both AC and DC applications; however when using DC control circuit the user must apply the following rules for coil selection of the contactor and latch combination:

- The CA7-9E...55E contactor uses an electronic DC coil and the CV7 latch coil code should be chosen from the table on the left. (i.e.: 24V DC control circuit select CA7-9E...55E with code 24E and CV7 latch uses a 48Z AC coil code).
- When DC control circuits are required use CA7-60D...97D contactors with standard two winding DC coil and the CV7 latch with AC coil selected from the table, top left. (i.e.: 125V DC control circuit should use 125DD coil code in the contactor and 240Z AC coil code in the CV7 latch).

① Other voltages available. Contact your Sprecher + Schuh representative.

② CV7 must be wired for momentary operation only.





③ Use 600V AC when 575 V is required.

④ Command duration 0.03...10 seconds.

⑤ Coil operating limits on CV7-11 match those of the contactor it is being used with.

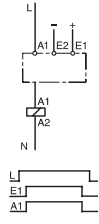

⑥ Not for use with CA7-90 (4-pole) contactors.

Control Modules (continued)

Module	Description	For use with...	Connection Diagrams	Function		Catalog Number
				Input	Output	
	<p>Electronic Interface – Interface between the DC control signal from a PLC and the AC operating mechanism of the contactor.</p> <ul style="list-style-type: none"> Requires no additional surge suppression for the coils Suitable for all CA7 contactors ② 	<p>CA7 all (with AC control)</p>		<p>24V DC ① 12V DC 48V DC</p>	<p>110... 240V AC</p>	<p>CR17E-24 CR17E-12 CR17E-48 <i>Gray is special order</i></p>
	<p>Surge Suppressors - Limits coil switching transients.</p> <ul style="list-style-type: none"> Plug-in, coil mounted Suitable for all CA7 contactors 	<p>CA7 all (with AC control)</p>		<p>RC Module - AC Control (50/60Hz) 24...48V 110...280V 380...480V</p>		<p>CRC7-48 CRC7-280 CRC7-480</p>
		<p>CA7-9C...43C (with conventional DC control)</p>		<p>Diode Module - DC Control 12-250VDC</p>		<p>CRD7-250 ③</p>
		<p>CA7 all (with AC control) CA7-9C...43C (with conventional DC control)</p>		<p>Varistor Module - AC/DC Control 12...55VAC/ 12...77VDC 56...136VAC/ 78...180VDC 137...277VAC/ 181...350VDC 278...575VAC</p>		<p>CRV7-55 ③ CRV7-136 ③ CRV7-277 ③ CRV7-575 ③</p>

① Control voltage 18...30V DC (10...15mA)
 ② Minimum actuation current is 5 volts, 2ma. The leakage current is <1mA for the following:
 • CR17E-12 @ 2.5 VDC input
 • CR17E-24 @5 VDC input
 • CR17E-48 @ 10 VDC input.
 ③ Electronic DC Contactors (CA7-9E...55E) include internal surge protection and do not require additional external surge protection.

AC Voltage Sag Immunity Modules

Module	Description	Full-Wave Bridge Rectifier		Catalog Number
		Module Input	Module Output	
		Control circuit voltage range	For use with CA7-60...97 contactors with DC coil	
	SEMI-F47-Module	24-250 VAC	24-250 VDC ①	CA7-SF47
	Semi-F47-Module with 1...30s on-delay timer	110-250 VAC	110-250 VDC ①	CA7-SF47A30

Sprecher + Schuh's CA7-SF47 module meets the Semi-F47 AC voltage sag immunity requirements to 50% voltage sag for 200 ms. Voltage sags can affect the readiness and operation of contactors and starters, resulting in shut downs, lost production, and diminished revenue. It is essential for process equipment to be compatible with its electrical environment. The CA7-SF47 voltage sag immunity module is an essential component to achieve equipment reliability during voltage sag events.

Product Features

- Meets Semi-F47 standard requirements
- For use with CA7-60...97 contactors with DC coils. A full-wave bridge rectifier internal to the CA7-SF47 module provides AC to DC coil voltage rectification.
- Suitable for contactor range (with screw terminals)
 - CA7-60...97, 3-Pole contactors
 - CA7-90, 4-Pole contactor
- Optional 1 to 30 seconds On-Delay timer function.

Benefits

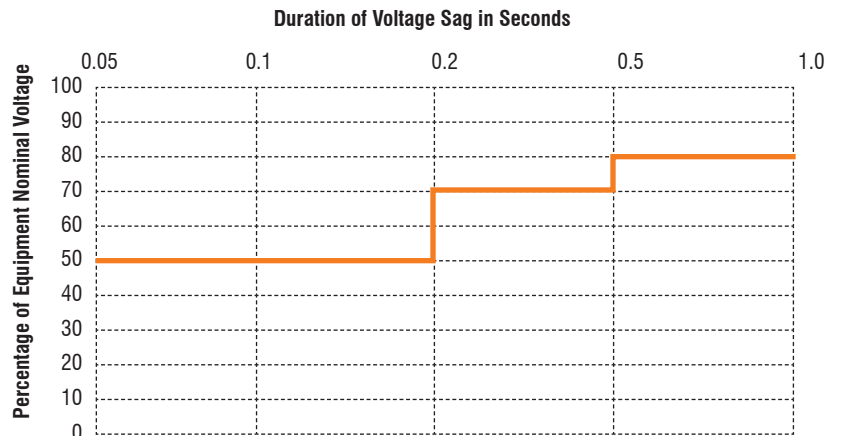

- Direct mounting to the coil terminals of the CA7 contactors. Only 24 mm is added to the component height.
- Direct electrical connection to the contactor. Customer coil power connections are made at the terminals of the CA7-SF47 module
- The CA7-SF47A30 module includes a 1 to 30 seconds adjustable On-Delay timer in addition to the voltage sag immunity functionality. Two independent functions in a single module.



VOLTAGE SAG DURATION				VOLTAGE SAG
Seconds	Milliseconds	Cycles at 60 hz	Cycles at 50 hz	Percent (%) of Equipment Nominal Voltage
< 0.05 s	< 50 ms	< 3 cycles	< 2.5 cycles	Not specified
0.05 to 0.2 s	50 to 200 ms	3 to 12 cycles	2.5 to 10 cycles	50%
0.2 to 0.5 s	200 to 500 ms	12 to 30 cycles	10 to 25 cycles	70%
0.5 to 1.0 s	500 to 1000 ms	30 to 60 cycles	25 to 50 cycles	80%
> 1.0 s	> 1000 ms	> 60 cycles	> 50 cycles	Not specified

① Input AC control circuit voltage must be matched when selecting the contactor/relay DC coil voltage.

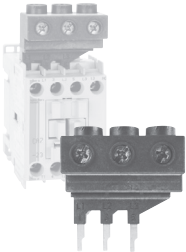
Terminal Lug Kits ①

Component	Description	For use with . . .	Maximum Resistive Current Ratings (A) ②			Pkg. Qty.	Catalog Number ①
			IEC (40°C)	IEC (60°C)	UL/CSA (40°C)		
	3 Pole Lug Kit – Allows larger wires to be used with the contactor. Ideal for wye-delta, reversing and multispeed contactors and starters. Can increase IEC AC-1 current rating, as well as the UL/CSA continuous current (resistive) rating of the contactor. Three pole kit used for smaller contactors.	CA7-9. . .23 -line side -load side	45	45	40	1	CA7-P-KN23 CA7-P-KL23
		CA7-30. . .37	60	55	55	1	CA7-P-K37
	1 Pole Lug Kit – Allows larger wires to be used with the contactor. Ideal for wye-delta, reversing and multispeed contactors and starters. Can increase AC-1 current rating of the contactor. One pole kit used for larger contactors.	CA7-43. . .55	90	75	75	3 ③	CA7-P-K43
		CA7-60. . .97	130	130	130	3 ③	CA7-P-K85

Paralleling Links ①②

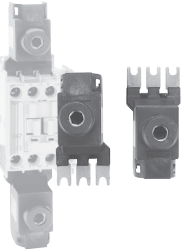
Component	Description	For use with . . .	Maximum Resistive Current Ratings (A) ②			Pkg. Qty.	Catalog Number ①
			IEC (40°C)	IEC (60°C)	UL/CSA (40°C)		
	3 Pole Paralleling Link – Allows smaller CA7 contactors to be used on single-phase resistive applications. By paralleling the three power poles, the contacts see only a portion of the actual load. ④	CA7-9. . .23	100	100	100	2 ③	CA7-P-B23
		CA7-30. . .37	150	135	150	2 ③	CA7-P-B37

Quick Connectors

Component	Description	For use with . . .	Pkg. Qty.	Catalog Number
	Stab Connectors - Dual stab (0.250 inch)	CA7-9. . .97 coil term. CA7-9. . .23 power term. CA7 accessories	20 100 100	CA7-SC2 CA7-SC10 CA4-SC11

① cULus Approved (File E33916).

② Lighting applications are not considered purely resistive loads. Therefore, the IEC and UL/CSA resistive ratings listed here do not apply to lighting loads. Lighting contactor ratings are provided in the Technical Information section.

③ Must be ordered in multiples of package quantity. For example on CA7-P-K43, order minimum quantity of 3 for one package of 3 pieces. Price is per piece.

④ Engineering practice permits 2.5 x Ie to be applied to a contactor when 3 poles are connected in parallel for single phase discharge lamp (ballast lighting) applications.

Reversing Components

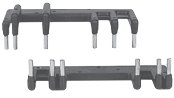
Component	Description	For Use With...	Catalog Number	Pkg. Qty.
	Dovetail Connectors – Connects multiple contactor and starter assemblies together.	CA7 all	CA7-S9	10
	Reversing Power Wiring Kit - ❶ Provides a solid "wireless" connection for reversing applications. May be used with both solid state and thermal O/L relays.	CA7-9...12 CA7-16...23	CAUT7-PW23	1
		CA7-30...37 CA7-43...55	CAUT7-PW37 CAUT7-PW55	1 1
		CA7-60...97	CAUT7-PW85	1

Reversing Power Wiring Kits

Only the kits are catalog items. Single components are available by special order in bulk packages of 20 pieces.

Reversing Starter Connection Kits ❷

Kit = CAUT7-PW23
CA7-PWNM23M

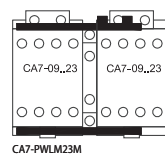

CA7-PWLM23M

Kit = CAUT7-PW37
CA7-PWNM37M

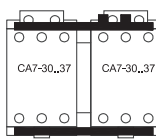

CA7-PWLM37M

Kit = CAUT7-PW55
CA7-PWNM55M

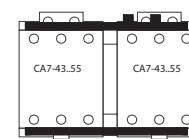

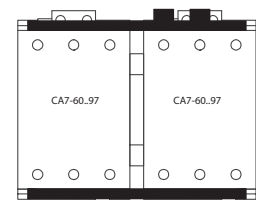

CA7-PWLM55M

Kit = CAUT7-PW85
CA7-PWNM85M



CA7-PWLM85M

Assembly Components

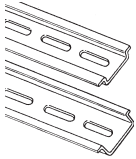
Component	Description	For Use With...	Catalog Number	Pkg. Qty.
	Protective Covers - Protects against unintended manual operation.	CA7 all	CA7-SCC	1
	Protective Covers - For front mounted auxiliary contacts, pneumatic timers and latches.	CS7-PV, CA7-PV, CZE7, CZA7, CV7	CA7-SCF	1
	DIN-rail - 2 meter lengths (6' 6"); price per rail Top Hat, low profile Top Hat, high profile	CA7 all	3F	20
			3AF	10

Marking Systems

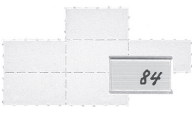
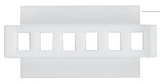
Component	Description	Catalog Number	Pkg. Qty.
	Label Sheet – 1 sheet with 105 self-adhesive paper labels, each 6 x 17mm	CA7-FMS	1
	Marking Tag Sheet - 1 sheet with 160 perforated paper labels each, 6 x 17mm. To be used with transparent cover.	CA7-FMP	1
		Transparent Cover - To be used with Marking Tag Sheets.	CA7-FMC
	Tag Carrier - For marking with marker cards and tags. See page N35 for complete listing of available cards and tabs.	CA7-FMA2	100 ❷

❶ cULus Approved (File E33916).

❷ Minimum quantity is one package of 100. Price is each x 100 = package price.

Wye-Delta Starter Kits ①

Wye-Delta power wiring kits were designed to aid in the field assembly of open-transition wye-delta starters that use CA7 contactors. These kits include line, load and start-point (shorting) connections. Assembling a wye-delta starter requires the use of the following components:

- Contactors and overload relay
- Mechanical / Electrical Interlock (Cat.No: CM7-02)
- Electronic Wye-delta Timer (Cat. No: CRZY7-30-110/240)
- Dovetail Connector to couple 1M and 2M contactor (Cat. No: CA7-S9); optional



Power Jumper Connection



Shorting Bar



Reversing Power Connection

Three Contactor Assembly Components

3-Phase Rating										For 3 contactor assembly ②	
kW (50Hz)				HP (60Hz)				Use with catalog number . . .			
230V	380V 415V	500V	690V	200V	230V	460V	575V	Delta	Wye		
								1M	2M	1S	Catalog Number
5.5	8	8	8	5	5	10	10	CA7-9	CA7-9	CA7-9	CAYT7-PW23
7.5	11	11	11	5	7.5	15	15	CA7-12	CA7-12	CA7-9	
10	14	15	14	7.5	10	20	20	CA7-16	CA7-16	CA7-12	
14	21	21	19	7.5	10	25	25	CA7-23	CA7-23	CA7-12	
18	28	28	28	10	15	30	30	CA7-30	CA7-30	CA7-16	CAYT7-PW37
19	35	35	32	15	20	40	40	CA7-37	CA7-37	CA7-23	
23	40	40	41	20	25	50	50	CA7-43	CA7-43	CA7-30	CAYT7-PW55
30	45	45	45	25	30	60	60	CA7-55	CA7-55	CA7-37	
33	58	60	56	30	40	75	75	CA7-60	CA7-60	CA7-37	CAYT7-PW72
39	69	67	70	40	50	100	100	CA7-72	CA7-72	CA7-43	
47	82	82	81	50	60	125	125	CA7-85	CA7-85	CA7-60	CAYT7-PW85
50	90	90	90	50	60	125	125	CA7-97	CA7-97	CA7-60	

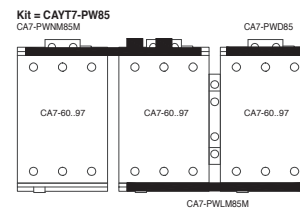
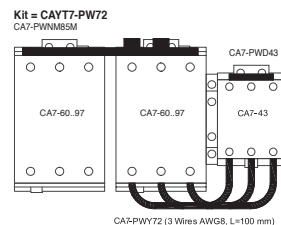
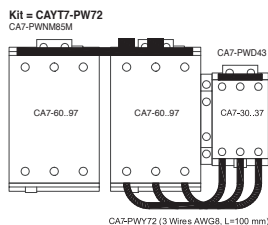
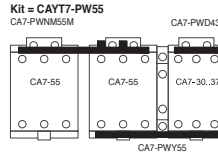
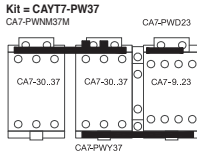
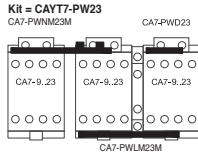

Two Contactor Assembly Components

When Connecting...		Load Side Power Connection	Shorting Bar
Delta	Wye		
2M	1S	Catalog Number	Catalog Number
CA7-30	CA7-30	CA7-PWLM37M	CA7-PWD43
CA7-37	CA7-37		
CA7-43	CA7-43	CA7-PWLM55M	CA7-PWD43
CA7-55	CA7-55		
CA7-60	CA7-60	CA7-PWLM85M	CA7-PWD85
CA7-72	CA7-72		
CA7-85	CA7-85		
CA7-97	CA7-97		

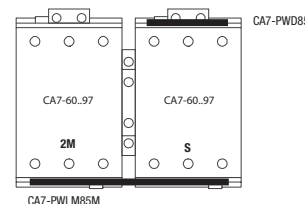
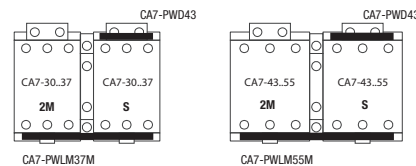

Two Contactor Wiring Connections are for Hydraulic Elevator Wye-Delta Contactors CA7Y2

① cULus Approved (File E33916).

② Individual parts of kits are available for unique applications by special order. Contact your Sprecher + Schuh Representative.

Renewal Coils - A.C. ①

AC Control Voltages			AC Coil Codes	For use with contactor . . .				
				CA7-9...16 CA7-9-M...16-M... CAQ7-16 CNX-205...206 CAN7-12...16 ~	CA7-23...37 CA7-23-M...37-M... CAQ7-37 CNX-207...209 CAN7-37 CAL(V)7-20-M40	CA7-43...55 ~ ~ CA7-40-M, CAN7-43 CAL(V)7-30-M40	CA7-60...85 ~ ~ CNX-212 CNX-218 CAN7-85 ~	CA7-97 CA7-90-M... ~ ~ CAL(V)7-60-M40
50 Hz	60 Hz	50/60 Hz	Cat. No.	Cat. No.	Cat. No.	Cat. No.	Cat. No.	
~	~	24V	24Z	TA855	TC855	TD855	TE855	TF855
32V	36V	~	36	~	~	~	TE481	~
48V	~	~	48A	~	TC414	TD414	~	~
110V	120V	~	120	TA473	TC473	TD473	TE473	TF473
115V	127V	~	127	TA424	TC424	~	~	~
200...220V	208.. 240V	~	220W	TA296	TC296	TD296	TE296	TF296
~	~	230V	230Z	TA851	TC851	TD851	TE851	TF851
240V	277V	~	277	TA480	TC480	TD480	TE480	TF480
400...415V	~	~	415	TA457	TC457	TD457	TE457	TF457
440V	480V	~	480	TA475	TC475	TD475	TE475	TF475
550V	600V	~	600	TA476	TC476	TD476	TE476	TF476

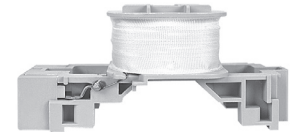

CA7 AC Coil (typical)

① AC Codes in bold letters and shaded indicate coils that are standard stocked items.

Renewal Coils - D.C. ①

DC Control Voltages	DC Coil Codes ①	Electronic DC Replacement Coils ④				Two Winding DC Replacement Coils	
		For use with contactor...				For use with contactor...	
		CA7-9E...16E CA7-9E-M...16E-M... CAN7-12E...16E	CA7-23E...37E CA7-23E-M... CAN7-37E	CA7-43E...55E CA7-40E-M... CAN7-43E (Series A)	CA7-43E...55E CA7-40E-M... CAN7-43E (Series B)	CA7-60D...85D ③ CNX7-218 CAN7-85D	CA7-97D ③ CA7-90D-M...
Cat. No.	Cat. No.	Cat. No.	Cat. No.	Cat. No.	Cat. No.		
		CA7-	CA7-	CA7-	CA7-	CA7-	CA7-
12V Electronic	12E	TC708E	TC708E	~	TD708E2	~	~
24V Electronic	24E	TC714E	TC714E	~	TD714E2	~	~
24V Diode ②	24DD	~	~	~	~	TE714M	TF714M
36-48V Elec	36E	TC719E	TC719E	~	TD719E2	~	~
48-72V Elec	48E	TC724E	TC724E	~	TD724E2	~	~
64V Diode	64DD	~	~	~	~	~	TF727M
72V Diode	72DD	~	~	~	~	TE728M	TF728M
110-125V Elec	110E	TC733E	TC733E	~	TD733E2	~	~
110V Diode	110DD	~	~	~	~	TE733M	TF733M
220-250V Elec	220E	TC747E	TC747E	~	TD747E2	~	~

Note: The “DD” coils listed above include an integrated bidirectional diode. Drop out time of this design is significantly improved when compared to an external diode. See ratings on page A69.

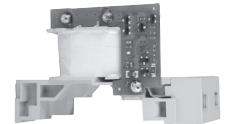

12V & 24V Electronic DC coil

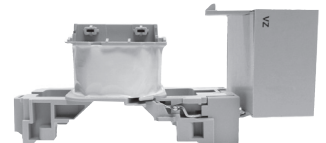

36V...220V Electronic DC coil with Back Pack



Two Winding DC coil (typical) ③

A

CA7 Contactors

- ① DC Codes in bold letters and shaded indicate coils that are standard stocked items.
- ② Voltage operating range: 0.7...1.25 x Us.
- ③ CA7-60D...97D contactors have a two winding coil with built-in late break auxiliary contact and coil suppression.
- ④ CA7-9E...55E electronic coils are not interchangeable with non-electronic DC or AC coils

CA7 Contactors

Replacement Contactors Cross Reference, Series CA1 to Series CA7 (Open Type Only) ①

I_e [A]		Ratings for Switching AC Motors (AC2 / AC3 / AC4)										Series CA1U Obsolete	Series CA7 Equivalent
		kW (50 Hz)				UL/CSA HP (60 Hz)							
		AC-3	AC-1	230V	400V / 415V	500V	690V	1 Ø		3 Ø			
115V	230V							200V	230V	460V	575V		
						1	3	5	5	10	10	CA1U-10	
16	32	5.5	7.5	7.5	7.5	1	3	5	5	10	15		CA7-16-10
						2	3	7-1/2	7-1/2	15	20	CA1U-14	
23	32	7.5	11	13	10	2	3	5	7-1/2	15	15		CA7-23-10
						2	5	7-1/2	10	20	25	CA1U-16	
30	65	10	15	15	15	2	5	7-1/2	10	20	25		CA7-30-10
						3	7-1/2	10	15	30	40	CA1U-25	
43	85	13	22	25	22	3	7-1/2	10	15	30	30		CA7-43-10
72	100	22	40	45	40	5	15	20	25	50	60		CA7-72-10
						5	15	25	25	50	60	CA1U-40	
85	100	25	45	55	45	7-1/2	15	25	30	60	60		CA7-85-10
						7-1/2	20	30	30	60	75	CA1U-55	
97	130	30	55	55	55	10	15	30	30	75	75		CA7-97-10

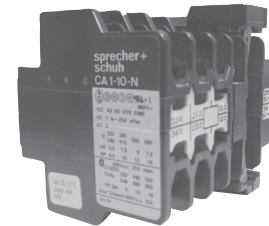

CA1U-10
Contactor

Replacement Contactors Cross Reference, Series CA3 to Series CA7 (Open Type Only) ①

I_e [A]		Ratings for Switching AC Motors (AC2 / AC3 / AC4)										Series CA3 Obsolete	Series CA7 Equivalent
		kW (50 Hz)				UL/CSA HP (60 Hz)							
		AC-3	AC-1	230V	400V / 415V	500V	690V	1 Ø		3 Ø			
115V	230V							200V	230V	460V	575V		
								2	2	5	7-1/2	CA3-9-10	
9	32	3	4	4	4	1/2	1 1/2	2	2	5	7-1/2		CA7-9-10
								3	3	7-1/2	10	CA3-12-10	
12	32	4	5.5	5.5	5.5	1/2	2	3	3	7-1/2	10		CA7-12-10
								5	5	10	15	CA3-16-10	
16	32	5.5	7.5	7.5	7.5	1	3	5	5	10	15		CA7-16-10
								5	5	10	15	CA3-23A-10	
23	32	7.5	11	13	10	2	3	5	7-1/2	15	15		CA7-23-10
								7-1/2	7-1/2	15	20	CA3-23-10	
30	65	10	15	15	15	2	5	7-1/2	10	20	25		CA7-30-10
								10	10	20	25	CA3-30-10	
								10	10	25	30		CA7-37-10
37	65	11	18.5/20	20	18.5	3	5	10	10	25	30	CA3-37	
43	85	13	22	25	22	3	7-1/2	10	15	30	30		CA7-43-10
								10	15	30	40	CA3-43	
								15	20	40	50	CA3-60	
55	85	15	30	30	22	5	10	15	20	40	40		CA7-55-10
60	100	18.5	32	37	32	5	10	15	20	40	50		CA7-60-10
								20	20	50	60	CA3-72	
72	100	22	40	45	40	5	15	20	25	50	60		CA7-72-10
85	100	25	45	55	45	7-1/2	15	25	30	60	60		CA7-85-10
97	130	30	55	55	55	10	15	30	30	75	75		CA7-97-10

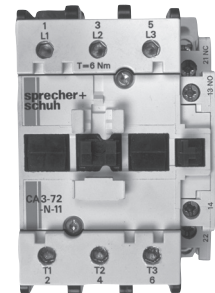

CA3-72
Contactor

① Available auxiliary contacts may vary. See selection pages for more information.