

Series CA6 Contactors

CA6 Contactors

A classic contactor for demanding applications from 75 to 600HP (@460V) - 100 to 700HP (@ 575V)

Sprecher + Schuh's CA6 contactor line combines the simple function of our popular CA7 series with the rugged performance demanded in this middle horsepower range. On average these contactors are 50% smaller than traditional contactors in this size class.

A broad selection for middle horsepower applications

The CA6 range consists of nine contactors in three frame sizes covering motors from 75 to 600HP at 460V and from 100 to 700HP at 575V. This line is ideally suited for demanding applications such as steel mills, rock quarries, mines or for any middle horsepower application where a sturdy, durable contactor is needed.



Rugged and reliable

CA6 contactors conform to UL508, IEC 60947 and can be operated at rated voltages up to 600V (UL) and 1000V (IEC). High thermal and switching capacities guarantee reliable operation and long life. CA6 contactors are listed in CSA Certified Elevator Equipment for heavy duty use in elevators, refrigerators and heating installations in Canada.

Arc quenching extends contact life

All CA6 contactors are designed with sophisticated arc quenching techniques that extinguish damaging breaking arcs quickly. This is accomplished by guiding the arc away from the contacts and into "arc chambers" which are built-in to every CA6 cover.

Safety first

CA6 arc chambers are completely enclosed (without arc exhaust vents), offering the best protection against hot arcing gases. A large safety distance in front of the contactor is unnecessary. CA6 contactors are also designed so that operation is impossible if the arc chambers are removed. Conversely, once the contactor is energized, the arc chambers cannot be removed.

When used with terminal covers or HB Touch-Safe Lugs, CA6 contactors meet international standards for touch-safe design.

DISCONTINUED
This series is being replaced by the CA9 Series of contactors

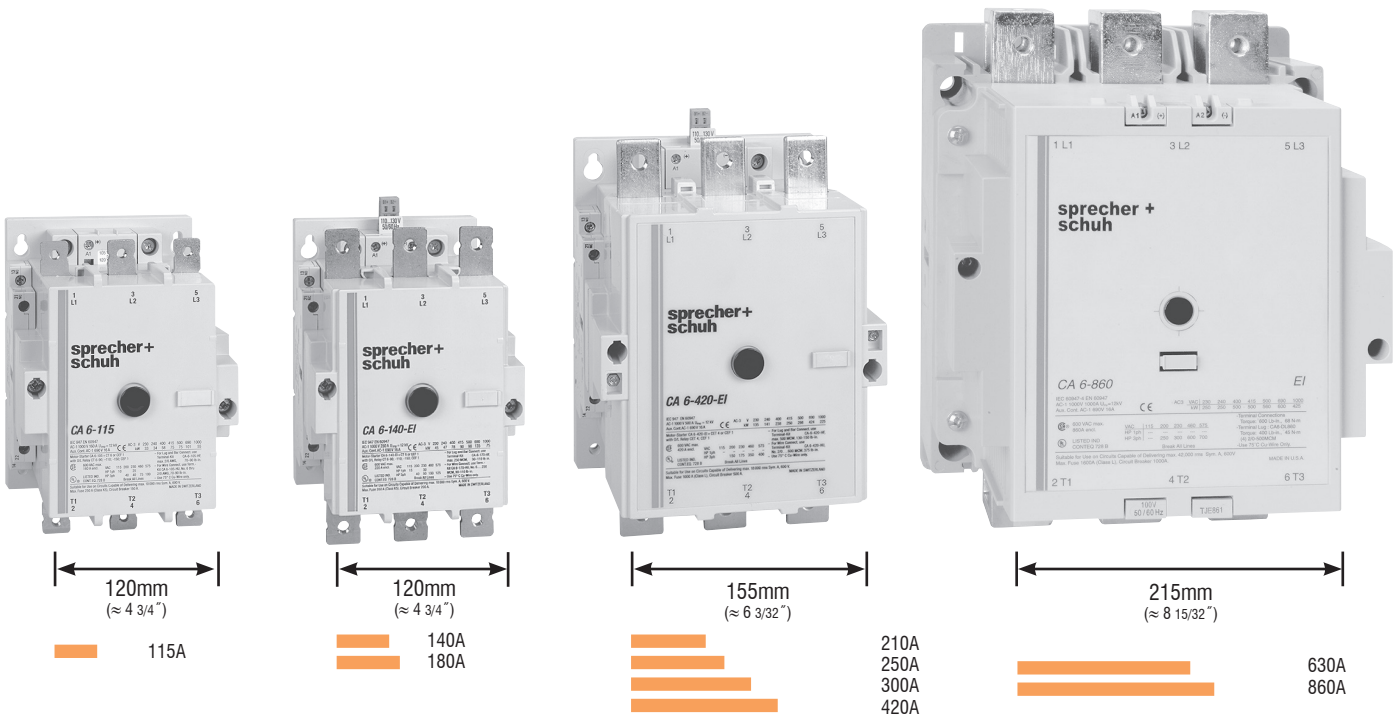

Electronic coils offer many advantages

Behind the attractive outward appearance of the CA6 contactor are advanced engineering solutions that offer convenience and savings. The entire line can be equipped with an electronically controlled coil that reduces pick-up currents by 60% on average. Holding current is also reduced.

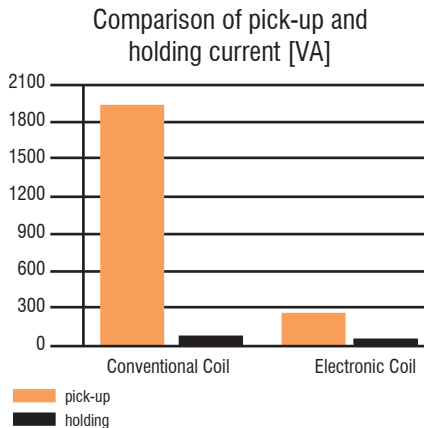

Other advantages of the CA6 electronic coil include:

- Direct connection to a PLC
- Overvoltage protection and suppression circuits (eliminating interference from the coil) are standard

The entire CA6 line is modularly designed for easy inspection, coil change and contact replacement. Maintenance can be performed from the front so that mounting requires no additional space. Even with the installation of mechanical interlocks and auxiliary contact blocks, the units can be flush mounted side by side, saving panel space.

- 1 CA6-115-EI Contactor
- 2 CA6-140-EI Contactor
- 3 Main Terminal Set
- 4 Lug set
- 5 Mechanical Interlock
- 6 Aux. Contact Block
- 7 Aux. Contact Block
- 8 Aux. Contact Block
- 9 Aux. Contact Block
- 10 Terminal Cover
- 11 Surge Suppressor

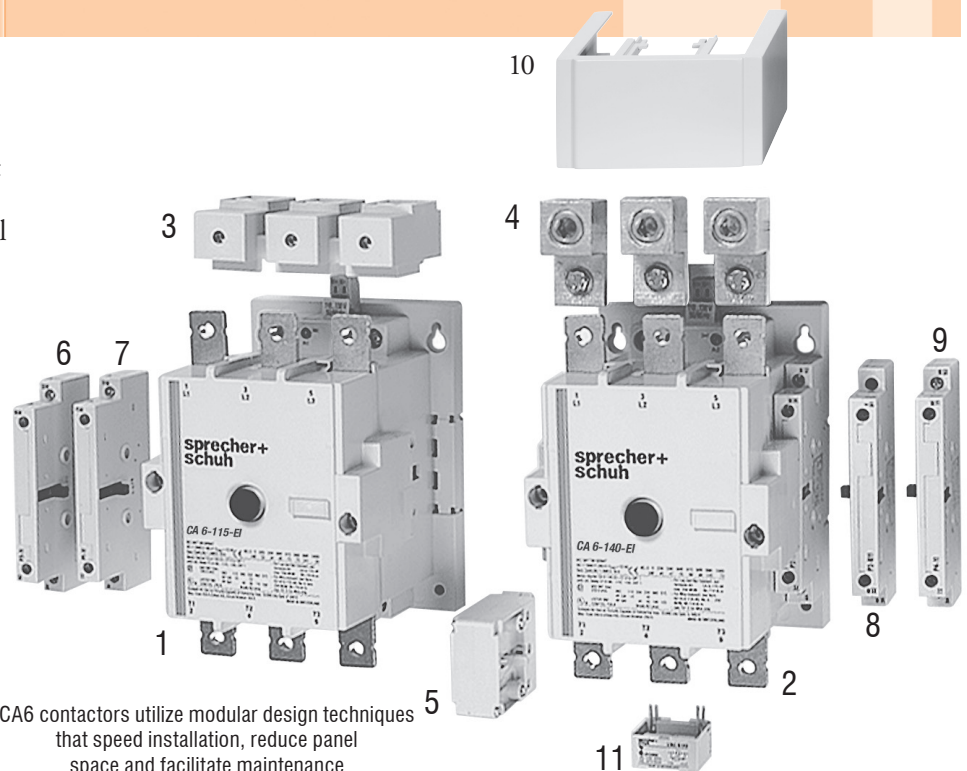

CA6 contactors utilize modular design techniques that speed installation, reduce panel space and facilitate maintenance

DISCONTINUED

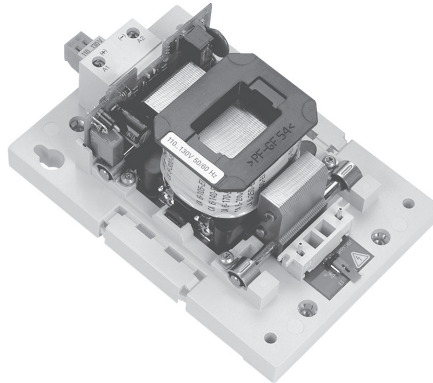

CA6 “EI” electronic coils offer many unique advantages over conventional types

- Smooth, even operation over the entire voltage range minimizes the possibility of contact bounce
- No safeguards are necessary to bridge brief supply interruptions
- Precisely defined pick-up and drop-out voltages, eliminate the possibility of chattering
- Electronic coils operate over a much broader voltage range, providing flexibility in applications and lower costs due to reduced inventory

Two user-selectable modes

CA6 contactors with electronic coils operate in either the “E” mode for normal operation or the “EI” mode for interfacing directly with a Programmable Logic Controller (PLC) or other low level signal source (13...30.2 VDC). The coil is set in the “E” mode from the factory, offering all of the functions and advantages of an electronic coil with the exception of electronic interface. An orange “jumper” located on the bottom of the contactor can be quickly changed if interface from a PLC is desired. A detailed technical explanation of CA6-EI coils along with connection diagrams can be found in the Technical Section.

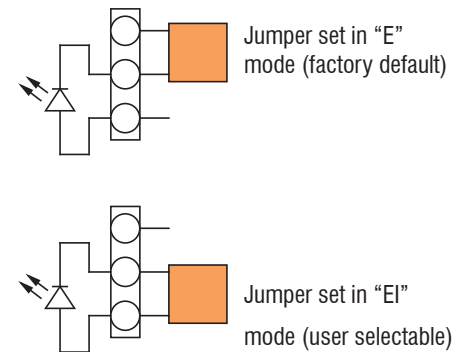

Non-Reversing, Three Pole Contactors With AC Coil, Series CA6 (Open type only) ①③

I _e [A]		Ratings for Switching AC Motors (AC2 / AC3)										Auxiliary Contacts per Contactor		Open Type	
		kW (50 Hz)				UL/CSA HP (60 Hz)									
		AC-3	AC-1	230V	400V/ 415V	500V	690V	1 Ø		3 Ø					
115V	230V							200V	230V	460V	575V				
115	250	37	64/66	80	111	10	25	40	40	75	100	1	1	CA6-115-11-*	694.86
														CA6-115-EI-11-*	836.12
140	250	45	78/82	80 ④	111	15	30	40	50	100	125	1	1	CA6-140-11-*	1142.52
														CA6-140-EI-11-*	1298.32
180	250	57	101/105	98 ④	135 ④	~	40	50	60	150	150	1	1	CA6-180-11-*	1599.53
														CA6-180-EI-11-*	1817.65
210	350	67	118/122	147	205	~	50	60	75	150	200	1	1	CA6-210-EI-11-*	1921.52
250	350	80	140/145	177	250	~	~	75	100	200	250	1	1	CA6-250-EI-11-*	2170.80
300	450	97	170/176	213	293	~	~	100	125	250	300	1	1	CA6-300-EI-11-*	2420.07
420	540	135	238/250	298	424	~	~	150	175	350	400	1	1	CA6-420-EI-11-*	5110.20
630	800	200	355	450	500	~	~	200	250	500	600	1	1	CA6-630-EI-11-*	9109.04
860	1000	250	500	560	~	~	~	250	300	600	700	1	1	CA6-860-EI-11-*	12360.04



CA6-140-EI contactor



CA6-420-EI contactor

Note: CA6 open-type contactors include terminal bolts. If lugs are required, see page A129 for ordering information.

Coil Codes ②

CA6-115 /140 /180		
AC Coil Code	Voltage Range	
	50 Hz	60 Hz
24	~	24V
120B	110V	120V
208	~	208V
240B	220-230V	240V
277	240V	277V
380	380-400V	440V
480	415V	480V
575	500V	575V

CA6-115-EI ...CA6-420-EI ①	
AC Coil Code	Voltage Range
	50 Hz / 60 Hz
24 ⑤	24V
120	110-130V
220W	208-277V
460W	380-500V

CA6-630-EI ...CA6-860-EI ①	
AC Coil Code	Voltage Range
	50 Hz / 60 Hz
120	110-130V ⑥
208W	200-220V
240W	230-250V ⑥
277	277V
480	440-480V

CA6 "EI" coils are electronically controlled coils with the following characteristics:

- Ability to connect directly to a low level signal source such as a PLC (13-30 VDC at 15mA max.)
- Very low pull-in and holding current for contactors in this size class
- Threshold voltages for pull-in and drop-out are very precisely defined, eliminating "chattering"
- Supply voltage dips are bridged without extra equipment
- "EI" coils cover a much wider voltage range with only one coil

Ordering Instructions

Specify Catalog Number	
Replace (*) with Coil Code	See Coil Codes on this page

- ① "EI" designates contactor with Electronic Interface coil.
- ② Other voltages available, see page A134-A135.
- ③ For CSA Elevator duty rating, consult Technical Information on page A139.
- ④ Ratings are higher for contactors with electronic coil:
CA6-140-EI-11-* CA6-180-EI-11-*
500V = 98 kW 500V = 126 kW
690V = 135 kW 690V = 176 kW
- ⑤ 24 VAC Coil is not available for CA6-420-EI.
- ⑥ Coil is rated AC/DC.

Non-Reversing, Three Pole Contactors With DC Coil, Series CA6 (Open type only) ①③

I _e [A]		Ratings for Switching AC Motors (AC2 / AC3)										Auxiliary Contacts per Contactor		Open Type		Price
		kW (50 Hz)				UL/CSA HP (60 Hz)										
		AC-3	AC-1	230V	400V/415V	500V	690V	1 Ø		3 Ø						
115V	230V							200V	230V	460V	575V	NO	NC			
115	250	37	64/66	80	111	10	25	40	40	75	100	1	1	CA6-115-L22-* CA6-115-EI-11-*	836.12	
140	250	45	78/82	80 ④	111	15	30	40	50	100	125	1	1	CA6-140-L22-* CA6-140-EI-11-*	1298.32	
180	250	57	101/105	98 ④	135 ④	~	40	50	60	150	150	1	1	CA6-180-L22-* CA6-180-EI-11-*	1817.65	
210	350	67	118/122	147	205	~	50	60	75	150	200	1	1	CA6-210-EI-11-*	1921.52	
250	350	80	140/145	177	250	~	~	75	100	200	250	1	1	CA6-250-EI-11-*	2170.80	
300	450	97	170/176	213	293	~	~	100	125	250	300	1	1	CA6-300-EI-11-*	2420.07	
420	540	135	238/250	298	424	~	~	150	175	350	400	1	1	CA6-420-EI-11-*	5110.20	
630	800	200	355	450	500	~	~	200	250	500	600	1	1	CA6-630-EI-11-*	9109.04	
860	1000	250	500	560	~	~	~	250	300	600	700	1	1	CA6-860-EI-11-*	12360.04	

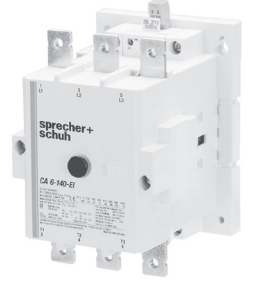

CA6-140-EI contactor with DC coil

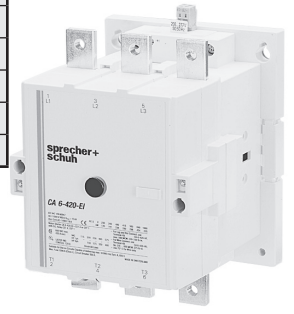

CA6-420-EI contactor with DC coil

Note: CA6 open-type contactors include terminal bolts. If lugs are required, see page A129 for ordering information.

Coil Codes ②

CA6-115 / 140 / 180	
DC Coil Code	Voltage Range
24D	24V
110D	110V
220D	220V

CA6-115-EI...CA6-420-EI ①	
DC Coil Code	Voltage Range
24D ⑤	24V
120D	110-130V
220D	200-255V

CA6-630...CA6-860-EI ①	
DC Coil Code	Voltage Range
120	110-130V ⑥
240W	200-255V ⑥

Note: Conventional DC coils have high current pick-up winding and low current "seal-in" winding wired in parallel. The pick-up winding is taken out of the circuit after the armature pulls in. Price includes two winding coil and an L11 block including one NC late break auxiliary contact mounted on the right side. See page A149 for functional schematic.

CA6 "EI" coils are electronically controlled coils with the following characteristics:

- Ability to connect directly to a low level signal source such as a PLC (13-30 VDC at 15mA max.)
- Very low pull-in and holding current for contactors in this size class
- Threshold voltages for pull-in and drop-out are very precisely defined, eliminating "chattering"
- Supply voltage dips are bridged without extra equipment
- "EI" coils cover a much wider voltage range with only one coil

Ordering Instructions

Specify Catalog Number	
Replace (*) with Coil Code	See Coil Codes on this page

- ① "-EI" designates contactor with Electronic Interface coil.
- ② Other voltages available, see page A134-A135.
- ③ For CSA Elevator duty rating, consult Technical Information on page A139.
- ④ Ratings are higher for contactors with electronic coil:
CA6-140-EI-11-* CA6-180-EI-11-*
500V = 98 kW 500V = 126 kW
690V = 135 kW 690V = 176 kW
- ⑤ 24V DC Coil not available for CA6-420-EI. Customers selecting 24V DC Coils should consider the "EI" functionality of the CA6 (see page A148).
- ⑥ Coil is rated AC/DC.

Reversing, Three Pole Contactors With AC Coil, Series CA6 (Open type only) ⑥

I _e [A]		Ratings for Switching AC Motors (AC2 / AC3)										Auxiliary Contacts per Contactor		Open Type	
		kW (50 Hz)					UL/CSA HP (60 Hz)								
		AC-3	AC-1	230V	400V/415V		500V	690V	1 Ø		3 Ø				
											115V	230V	200V	230V	460V
115	250	37	64/66	80	111	10	25	40	40	75	100	1	1	CAU6-115-22-* CAU6-115-EI-22-*	1963.06 2139.64
140	250	45	78/82	80 ⑦	111	15	30	40	50	100	125	1	1	CAU6-140-22-* CAU6-140-EI-22-*	2814.76 3147.14
180	250	57	101/105	98 ⑦	135 ⑦	~	40	50	60	150	150	1	1	CAU6-180-22-* CAU6-180-EI-22-*	3413.98 4206.57
210	350	67	118/122	147	205	~	50	60	75	150	200	1	1	CAU6-210-EI-22-*	4850.54
250	350	80	140/145	177	250	~	~	75	100	200	250	1	1	CAU6-250-EI-22-*	5349.09
300	450	97	170/176	213	293	~	~	100	125	250	300	1	1	CAU6-300-EI-22-*	5920.35
420	540	135	238/250	298	424	~	~	150	175	350	400	1	1	CAU6-420-EI-22-*	11217.51
630	800	200	355	450	500	~	~	200	250	500	600	1	1	CAU6-630-EI-22-*	20253.84
860	1000	250	500	560	~	~	~	250	300	600	700	1	1	CAU6-860-EI-22-*	26797.39

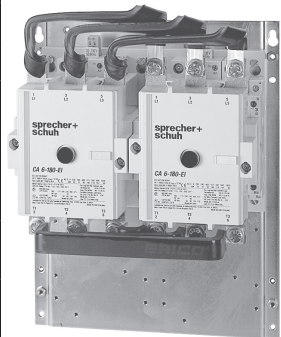

CAU6-180 reversing contactor

Includes:

- Mechanical and electrical Interlock ④
- Reversing power wiring (using Power Wiring Kit Cat.# CA6-...VL[T]) ①
- Mounting plate
- Control wiring available; see footnote ②

Note: CA6 open-type contactors include terminal bolts. If lugs are required, see page A129 for ordering information.

Coil Codes ②

CA6-115 /140 180		
AC Coil Code	Voltage Range	
	50 Hz	60 Hz
24	~	24V
120B	110V	120V
208	~	208V
240B	220-230V	240V
277	240V	277V
380	380-400V	440V
480	415V	480V
575	500V	575V

CA6-115-EI ...CA6-420-EI ①		
AC Coil Code	Voltage Range	
	50 Hz / 60 Hz	
24 ③	24V	
120	110-130V	
220W	208-277V	
460W	380-500V	

CA6-630-EI ...CA6-860-EI ①		
AC Coil Code	Voltage Range	
	50 Hz / 60 Hz	
120	110-130V ③	
208W	200-220V	
240W	230-250V ③	
277	277V	
480	440-480V	

① For -LW Option Deduct the following from List Price	
CAU6-115...180	181.77
CAU6-210...860	373.92
② For -CW Option Add the following to List Price	
All CAU6	20.73

Ordering Instructions

Specify Catalog Number	
Replace (*) with Coil Code	See Coil Codes on this page

CA6 "EI" coils are electronically controlled coils with the following characteristics:

- Ability to connect directly to a low level signal source such as a PLC (13-30 VDC at 15mA max.)
- Very low pull-in and holding current for contactors in this size class
- Threshold voltages for pull-in and drop-out are very precisely defined, eliminating "chattering"
- Supply voltage dips are bridged without extra equipment
- "EI" coils cover a much wider voltage range with only one coil

- ① For Reversing Contactors without power wiring add suffix "-LW" to catalog number. For example: CAU6-115-22-* becomes CAU6-115-22-*LW. Control wiring is not included.
- ② For control wiring, add suffix -CW to catalog number. For example: CAU6-115-22-* becomes CAU6-115-22-*CW.
- ③ "-EI" designates contactor with Electronic Interface coil.
- ④ One NC auxiliary contact on each contactor is used for electrical interlocking.
- ⑤ Other voltages available, see page A134-A135.
- ⑥ For CSA Elevator duty rating, consult Technical Information on page A139.
- ⑦ Ratings are higher for contactors with electronic coil:

CA6-140-EI-11-*	CA6-180-EI-11-*
500V = 98 kW	500V = 126 kW
690V = 135 kW	690V = 176 kW
- ⑧ 24 VAC Coil is not available for CA6-420-EI.
- ⑨ Coil is rated AC/DC.

Reversing, Three Pole Contactors With DC Coil, Series CA6 (Open type only) ⑥

I _e [A]		Ratings for Switching AC Motors (AC2 / AC3)										Auxiliary Contacts per Contactor		Open Type	
		kW (50 Hz)				UL/CSA HP (60 Hz)									
		AC-3	AC-1	230V	400V/415V	500V	690V	1 Ø			3 Ø				
115V	230V							200V	230V	460V	575V	NO	NC④		
115	250	37	64/66	80	111	10	25	40	40	75	100	2	1	CAU6-115-L42-* CAU6-115-EI-22-*	2285.05 2513.55
140	250	45	78/82	80 ⑦	111	15	30	40	50	100	125	2	1	CAU6-140-L42-* CAU6-140-EI-22-*	3354.87 3780.72
180	250	57	101/105	98 ⑦	135 ⑦	~	40	50	60	150	150	1	1	CAU6-180-L42-* CAU6-180-EI-22-*	4528.55 5099.81
210	350	67	118/122	147	205	~	50	60	75	150	200	1	1	CAU6-210-EI-22-*	5785.33
250	350	80	140/145	177	250	~	~	75	100	200	250	1	1	CAU6-250-EI-22-*	6408.52
300	450	97	170/176	213	293	~	~	100	125	250	300	1	1	CAU6-300-EI-22-*	7104.42
420	540	135	238/250	298	424	~	~	150	175	350	400	1	1	CAU6-420-EI-22-*	13606.43
630	800	200	355	450	500	~	~	200	250	500	600	1	1	CAU6-630-EI-22-*	20253.84
860	1000	250	500	560	~	~	~	250	300	600	700	1	1	CAU6-860-EI-22-*	26797.39

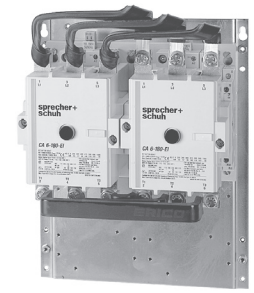

CAU6-180 reversing contactor with DC coil

Includes:

- DC operating mechanism
- Mechanical and electrical Interlock ④
- Reversing power wiring (using Power Wiring Kit Cat.# CA6-...VL[T]) ①
- Mounting plate
- Control wiring available; see footnote ②

Note: CA6 open-type contactors include terminal bolts. If lugs are required, see page A129 for ordering information.

Coil Codes ⑤

CA6-115 / 140 / 180	
DC Coil Code	Voltage Range
24D	24V
110D	110V
220D	220V

Note: Conventional DC coils have high current pick-up winding and low current "seal-in" winding wired in parallel. The pick-up winding is taken out of the circuit after the armature pulls in. Price includes two winding coil and an L11 block including one NC late break auxiliary contact mounted on the right side. See page A149 for functional schematic.

CA6-115-EI...CA6-420-EI ①③	
DC Coil Code	Voltage Range
24D ⑥	24V
120D	110-130V
220D	200-255V

CA6-630...CA6-860-EI ①③	
DC Coil Code	Voltage Range
120	110-130V ⑨
240W	200-255V ⑨

① For -LW Option Deduct the following from List Price	
CAU6-115...180	181.77
CAU6-210...860	373.92
② For -CW Option Add the following to List Price	
All CAU6	20.73

CA6 "EI" coils are electronically controlled coils with the following characteristics:

- Ability to connect directly to a low level signal source such as a PLC (13-30 VDC at 15mA max.)
- Very low pull-in and holding current for contactors in this size class
- Threshold voltages for pull-in and drop-out are very precisely defined, eliminating "chattering"
- Supply voltage dips are bridged without extra equipment
- "EI" coils cover a much wider voltage range with only one coil

- ① For Reversing Contactors *without* power wiring add suffix "-LW" to catalog number. For example: CAU6-115-22-* becomes CAU6-115-22-***-LW**. Control wiring is not included.
- ② For control wiring, add suffix **-CW** to catalog number. For example: CAU6-115-22-* becomes CAU6-115-22-***-CW**.
- ③ "-EI" designates contactor with Electronic Interface coil.
- ④ One NC auxiliary contact on each contactor is used for electrical interlocking.
- ⑤ Other voltages available, see page A134-A135.
- ⑥ For CSA Elevator duty rating, consult Technical Information on page A139.
- ⑦ Ratings are higher for contactors with electronic coil:
CA6-140-EI-11-* CA6-180-EI-11-*
500V = 98 kW 500V = 126 kW
690V = 135 kW 690V = 176 kW
- ⑧ 24V DC Coil not available for CA6-420-EI. Customers selecting 24V DC Coils should consider the "EI" functionality of the CA6 (see page A148).
- ⑨ Coil is rated AC/DC

Ordering Instructions

Specify Catalog Number	
Replace (*) with Coil Code	See Coil Codes on this page

Non-Reversing, Three Pole NEMA Labeled Contactors with AC Coil ①③

NEMA Size	Maximum Horsepower						Standard Auxiliary Contacts		Catalog Number	Price
	1Ø		3Ø				NO	NC		
	115V	230V	200V	230V	460V	575V				
00	1/3	1	1-1/2	1-1/2	2	2	1	0	CAN7-12-10-*	See page A42
0	1	2	3	3	5	5	1	0	CAN7-16-10-*	
1	2	3	7-1/2	7-1/2	10	10	1	0	CAN7-37-10-*	
2	3	7-1/2	10	15	25	25	1	0	CAN7-43-10-*	
3	7-1/2	15	25	30	50	50	1	0	CAN7-85-10-*	
4	~	~	40	50	100	100	1	1	CAN6-180-11-*	2723.96
									CAN6-180-EI-11-*	3159.29
5	~	~	75	100	200	200	1	1	CAN6-300-EI-11-*	6767.39



CAN6 NEMA labeled contactor (AC)



Application Notes

- NEMA contactors are UL Listed and rated in accordance with the requirements of NEMA standards publication ICS-2. These contactors are labeled for applications that require compliance with NEMA standards.
- Sizes are based on standard NEMA classifications.
- Easy coil change and contact replacement. See pages A134-A135 for coils and contacts.
- Snap-on auxiliary contact blocks available in many configurations. See page A132 (CA[N]6).

Note: CAN6 open-type contactors include terminal bolts. If lugs are required, see page A129 for ordering information.

CAN6 AC Coil Codes Conventional Coils ②

AC Coil Code	CAN6-180 Voltage Range	
	50 Hz	60 Hz
	24	~
120B	110V	120V
208	~	208V
240B	220-230V	240V
277	240V	277V
380	380V-400V	440V
480	415V	480V
575	500V	575V

CAN6 AC Coil Codes “EI” Electronic Coils ②③

AC Coil Code	CAN6-180-EI...300-EI Voltage Range
	50 Hz / 60 Hz
	24
120	110-130V
220W	208-277V
460W	380-500V

Ordering Instructions

Specify Catalog Number	
Replace (*) with Coil Code	See Coil Codes on this page.

- ① Refer to page A154 for CAN6 dimensions.
- ② Other voltages available, see pages A134-A135 for CAN6 coils.
- ③ “EI” designates contactor with Electronic Interface coil.

Non-Reversing, Three Pole NEMA Labeled Contactors with DC Coil ①

NEMA Size	Maximum Horsepower						Standard Auxiliary Contacts		Catalog Number	Price
	1Ø		3Ø				NO	NC		
	115V	230V	200V	230V	460V	575V				
00	1/3	1	1-1/2	1-1/2	2	2	1	0	CAN7-12E-10-* ⑤	See page A43
0	1	2	3	3	5	5	1	0	CAN7-16E-10-* ⑤	
1	2	3	7-1/2	7-1/2	10	10	1	0	CAN7-37E-10-* ⑤	
2	3	7-1/2	10	15	25	25	1	0	CAN7-43E-10-* ⑤	
3	7-1/2	15	25	30	50	50	2	1	CAN7-85D-10-*	
4	~	~	40	50	100	100	1	1	CAN6-180-L22-* ④	3060.83
									CAN6-180-EI-11-* ③④	3159.29
5	~	~	75	100	200	200	1	1	CAN6-300-EI-11-* ③④	6767.39



CAN6 NEMA labeled contactor



A
CAN6 Contactors

Application Notes

- NEMA contactors are UL Listed and rated in accordance with the requirements of NEMA standards publication ICS-2. These contactors are labeled for applications that require compliance with NEMA standards.
- Sizes are based on standard NEMA classifications.
- Easy coil change and contact replacement. See pages A134-A135 for coils and contacts.
- Snap-on auxiliary contact blocks available in many configurations. See page A132.

Note: CA6 open-type contactors include terminal bolts. If lugs are required, see page A129 for ordering information.

CAN6 DC Coil Codes

Conventional Coils ②④

CAN6-180-L22	
DC Coil Code	Voltage Range
24D	24V

CAN6 DC Coil Codes

“EI” Electronic Coils ②④

CAN6-180-EI...300-EI	
DC Coil Code	Voltage Range
24D	24V

Ordering Instructions

Specify Catalog Number	
Replace (*) with Coil Code	See Coil Codes on this page.

- ① Refer to page A154 for CAN6 dimensions.
- ② Other voltages available, see pages A134-A135 for CAN6 coils.
- ③ “-EI” designates contactor with Electronic Interface coil.
- ④ Customers with 24VDC applications should strongly consider using the “EI” functionality of the CA6 (see pages A148-A149).

Hydraulic Elevator Wye Delta, with AC Coils (Two Contactor Type ①②⑤)

Maximum Horsepower Three Phase				Auxiliary Contacts per Contactor		Open Type	Price
200V	230V	460V	575V	NO	NC ③	Catalog No.	
60 40	60 50	125 100	150 125	1	1	CA6Y2-115-22-∗-LW CA6Y2-115-EI-22-∗-LW	1654.59 1848.81
60 50	75 60	175 125	200 125	1	1	CA6Y2-140-22-∗-LW CA6Y2-140-EI-22-∗-LW	2578.99 2911.36
75 60	100 75	200 150	250 150	1	1	CA6Y2-180-22-∗-LW CA6Y2-180-EI-22-∗-LW	3520.02 3535.60

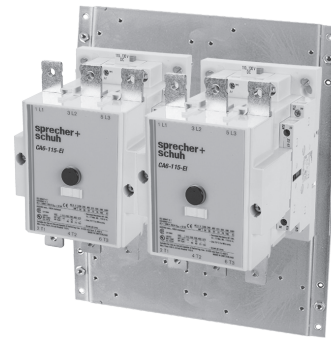

CA6Y2-115 Wye-Delta contactor

Includes:

- Mechanical and electrical Interlocks ③
- Mounting plate

Optional:

- Power wiring available but not included (see page A130) ①⑦

HP Selection	
Industrial Application ⑤	CSA Elevator Duty ⑥

Larger sizes are possible. Contact your Sprecher + Schuh representative.

CA6 “EI” coils are electronically controlled coils with the following characteristics:

- Ability to connect directly to a low level signal source such as a PLC (13-30 VDC at 15mA max.)
- Very low pull-in and holding current for contactors in this size class
- Threshold voltages for pull-in and drop-out are very precisely defined, eliminating “chattering”
- Supply voltage dips are bridged without extra equipment
- “EI” coils cover a much wider voltage range with only one coil

Coil Codes ④

CA6-115...180		
AC Coil Code	Voltage Range	
	50 Hz	60 Hz
24	~	24V
120B	110V	120V
208	~	208V
240B	220-230V	240V
277	240V	277V
380	380-400V	440V
480	415V	480V
575	500V	575V

CA6-115-EI ...CA6-180-EI ①		
AC Coil Code	Voltage Range	
	50 Hz / 60 Hz	
24	24V	
120	110-130V	
220W	208-277V	
440W	380-440V	

① For -PW Option Add the following to List Price	
CA6Y2-115...180	283.56

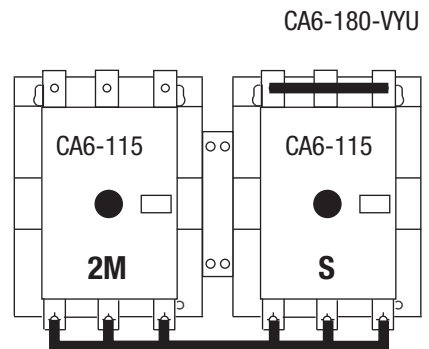



CA6-180-VLHB

Ordering Instructions

Specify Catalog Number	
Replace (∗) with Coil Code	See Coil Codes on this page.

- ① For Contactors with power wiring add suffix “-PW” to catalog number. For example: CA6Y2-115-22-∗-LW becomes CA6Y2-115-22-∗-PW. Control wiring is not included.
- ② “EI” designates contactor with Electronic Interface coil.
- ③ One NC auxiliary contact on each contactor is used for electrical interlocking.
- ④ Other voltages available, see page A134-A135.
- ⑤ HP selection based on UL508 for Industrial Applications.
- ⑥ HP selection based on CSA Elevator Duty Ratings.
- ⑦ See typical Wye-Delta Wiring Diagram on page C117.

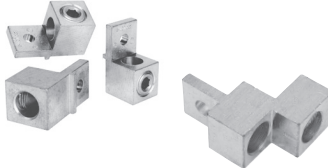
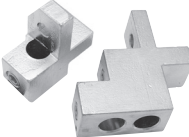
Main Lugs and Lug Accessories





Lug or Accessory	Connection	Description	Catalog Number	Price
 <p>Multiple conductors (flat or round) fit in each terminal on CA6-HB Main Terminal Sets (top view)</p>	<ul style="list-style-type: none"> Accommodation for dual connections to each pole Accepts flat or round conductors Touch safe to IP20 according to IEC 60529 Eliminates need for Terminal Shields <p>Main Terminal Sets (catalog #: CA6-HB...) are specifically designed for connecting line and load to all three poles on CA6 contactors. Each touch safe terminal set contains three built-in terminals capable of carrying two round conductors or multiple flat conductors. Main Terminal Sets add a clean finished appearance to CA6 contactors</p>	<p>Main Terminal Set, Dual Conductor, Touch Safe (price as complete set, containing 2 blocks, 6 lugs)</p> <p>For CA6-115(-EI); 140(-EI); 180(-EI)</p> <p>For CA6-210-EI to 420-EI</p>	<p>CA6-HB2</p> <p>CA6-HB3</p>	<p>129.83</p> <p>195.27</p>
	<p>Screw Type Lugs -</p> <ul style="list-style-type: none"> Single connections to each pole Accepts round conductors only Copper construction <p>(set of 3 - two sets required to wire line and load sides)</p>	<p>For CA6-115(-EI); 140(-EI); 180(-EI)</p> <p>For CA6-210-EI to CA6-420-EI</p>	<p>CA6-L180</p> <p>CA6-L420</p>	<p>85.17</p> <p>185.92</p>
	<p>Screw Type Lugs -</p> <ul style="list-style-type: none"> Accommodation for dual connections to each pole Accepts round conductors only Copper construction <p>(set of 3 - two sets required to wire line and load sides)</p>	<p>For CA6-630-EI</p>	<p>CA6-L630</p>	<p>327.18</p>
	<p>Screw Type Lugs -</p> <ul style="list-style-type: none"> Accommodation for dual connections to each pole Accepts round conductors only Copper construction <p>(set of 3 - two sets required to wire line and load sides)</p>	<p>For CA6-860-EI</p>	<p>CA6-L860</p>	<p>473.63</p>
 <p>(Typical)</p>	<p>Control Wire Terminal ① 2 x 2.5mm²</p>	<p>For CA6-115(-EI); 140(-EI); 180(-EI)</p> <p>For CA6-210-EI to 420-EI</p>	<p>CA6-AT1</p> <p>CA6-AT2</p>	<p>5.47</p> <p>14.96</p>

① The IP2X lug rating will no longer apply if used with CA6-HB_ main terminal set.



See Page A145 for terminal wire ranges.

A
CA6 Contactors

Power Wiring Connection Kits







Connection Kits	Application	Used with contactor...	Use with Lug...	Catalog Number	Price
 CA6-180-VLHB	Reversing Line Side Wye-Delta Line Side Connects L1-L1 L2-L2 L3-L3	CA6-115(-EI) to 180(-EI)	CA6-L180	CA6-180-VLHB	118.41
		CA6-115(-EI) to 180(-EI)	CA6-HB2		
		CA6-210-EI to 420-EI	CA6-HB3	CA6-420-VLHB	284.59
			CA6-420-HU CA6-L420		
CA6-630-EI to 860-EI	CA6-L630 CA6-L860	CA6-860-VL	545.30		
 CA6-180-VT	Reversing Load Side Connect T1-T3 T2-T2 T3-T1	CA6-115(-EI) to 180(-EI)	CA6-L180	CA6-180-VT	153.73
		CA6-115(-EI) to 180(-EI)	CA6-HB2	CA6-180-VTHB	153.73
		CA6-210-EI to 420-EI	CA6-HB3	CA6-420-VTHB	286.67
		CA6-210-EI to 420-EI	CA6-420-HU CA6-L420	CA6-420-VT	273.17
		CA6-630-EI to 860-EI	CA6-L860	CA6-860-VT	500.63
 CA6-180-VYU	Wye-Delta Shorting Bar	CA6-115(-EI) to 180(-EI) CA6-210-EI to 420-EI	N/A	CA6-180-VYU CA6-420-VYU	15.48 31.47
		CA6-630-EI to 860-EI	N/A	CA6-860-VYU	62.00
 CA6-420-VT	Wye-Delta (2M to S jumper)	Connects 2M contactor CA6-210-EI to 420-EI... to S contactor CA6140(-EI) to 180(-EI)	CA6-HB3	CA6-420-VYHB	243.05
		Connects 2M contactor CA6-210-EI to 420-EI... to S contactor CA6-210-EI to 420-EI	CA6-420-HU CA6-L420	CA6-420-VT	273.17

Lug Accessories and Backpans

Accessory	Description	For use with contactor...	Catalog Number	Price	
	Main Terminal Cover - ❶ • CA6 touch protection • Line or load (price each) • IP20; IEC60529 & DIN 40 050 protection	CA6-115(-EI) to 180(-EI)	CA6-TC180	46.42	
		CA6-210-EI to 420-EI	CA6-TC420	76.34	
		CA6-630-EI to 860-EI	CA6-TC860	111.13	
		CA6-630-EI to 860-EI	CA6-TCS860 ❷	52.14	
		CA6-630-EI to 860-EI	CA6-TCR860 ❸	435.20	
		CA6-630-EI to 860-EI	CA6-TCE860 ❹	492.33	
	Mounting Plates – 1 contactor & 1 O/L relay (Across-The-Line)	CA6-115(-EI)...180(-EI)	CA6-MS180	63.57	
		CA6-210-EI...420-EI	CA6-MS420	102.41	
		CA6-630-EI...860-EI	CA6-MS860	256.54	
		2 contactors & 2 O/L relays (Reversing or Multispeed)	CA6-115(-EI)...180(-EI)	CA6-MU180	102.41
			CA6-210-EI...420-EI	CA6-MU420	153.73
			CA6-630-EI...860-EI	CA6-MU860	311.60
	3 contactors, 2 O/L relays & 1 relay/timer (Wye-delta)	For CA6-115(-EI) to 180(-EI)	CA6-MY180	175.54	
For CA6-210-EI to 420-EI		CA6-MY420	211.89		
CA6-630-EI to 860-EI		CA6-MY860	368.72		

- ❶ Terminal Covers not necessary when using Main Terminal Sets (CA6-HB...) which are insulated.
- ❷ DOL starter/relay terminal covers
- ❸ Reversing starter/relay terminal cover
- ❹ Line-side panel relay and reversing terminal cover



Auxiliary Contact Blocks, 2 Pole

Auxiliary Contact Blocks	NO	NC	Contact Arrangement	Mounting Position	Catalog Number	Price
	1	1		Inside left or right	CA6-S1-11	46.22
	1	1		Outside left or right	CA6-S2-11	46.22
	1	1 LB		Inside left or right	CA6-S1-L11	53.49
	2	0		Inside left or right	CA6-S1-20	46.22
	2	0		Outside left or right	CA6-S2-20	46.22
	Form C Electronic Compatible				Inside left or right	CA6-S1-B11 Ⓢ

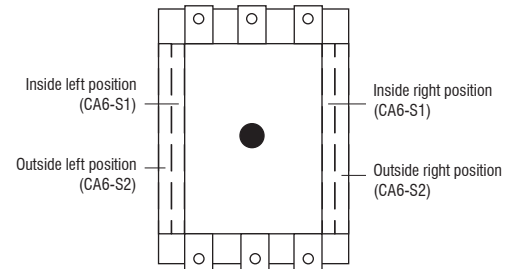
NOTE: Up to four auxiliary contact blocks (8 poles) may be mounted on the side of the CA6 contactor. One auxiliary contact block (1 NO + 1 NC) is mounted at the factory. New style CA6-115...140 contactors with conventional DC coils have an "-L11" mounted to right side and an "-11" mounted to left side at the factory.



Miscellaneous Accessories

Accessory	Description	For use with...	Catalog Number	Price
 CM6-D00	Mechanical Interlock • No built-in auxiliaries	Interlocks CA6 contactors	CM6-D00	57.02
 CM6-D02	Mechanical / Electrical Interlock - • Two built-in N.C. auxiliaries	Interlocks CA6 to CA7-60...97 contactors	CM6-C02	68.35
		Interlocks CA6 contactors	CM6-D02	68.35

Ⓢ Electronic compatible auxiliary contacts function through the use of an internal micro-switch and have the following ratings:

IEC 947 Data:



AC-1	250V	0.1A
AC-15/DC-13 min.	3...125V	1...100mA

UL 508, CSA 22.2 Data: 250VAC max. 0.1A
Minimum Switching 17V 5mA

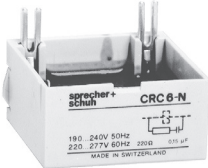
Miscellaneous Accessories

Accessory	Description	For use with...	Catalog Number	Price
	<p>Surge Suppressor - Limits voltage spikes when switching off coil. Attaches to all CA6 contactors.</p> <p>RC Link: 21-48V 50Hz / 24-55V 60Hz 95-110V 50 Hz / 110-127V 60 Hz 190-240V 50Hz / 220-277V 60Hz 380-550V 50Hz / 440-575V 60Hz</p>	Conventional AC Coils	<p>CRC6-48 CRC6-110 CRC6-240 CRC6-550</p>	38.02
	<p>Varistor Link: 12-55V 50/60Hz 56-136V 50/60Hz 137-277V 50/60Hz 278-575V 50/60Hz</p>	Conventional AC Coils	<p>CRV6-55 CRV6-136 CRV6-277 CRV6-575</p>	24.30
	<p>Varistor Link: 24-28V AC/DC 48-72V DC 43-65V 50/60Hz 208-277 50/60 Hz 380-400V 50/60Hz</p>	Electronic (-EI) Coils ①	<p>CRV6-40 CRV6-55 CRV6-75 CRV6-550 CRV6-460</p>	24.30

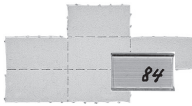
Marking Systems

Component	Description	Pkg. Qty.	Catalog Number	Price Each
	<p>Label Sheet - 1 sheet with 105 self-adhesive paper labels each, 6 x 17mm</p>	1	CA7-FMS	See page A54
	<p>Marking Tag Sheet - 1 sheet with 160 perforated paper labels each, 6 x 17mm. To be used with transparent cover</p>	1	CA7-FMP	
	<p>Transparent Cover - To be used with Marking Tag Sheets</p>	100 ②	CA7-FMC	
	<p>Tag Carrier - For marking with marker cards and tags. See page N35 for complete listing of available cards and tabs.</p>	100 ②	CA7-FMA2	

① “EI” contactors are supplied with factory installed integrated surge protection (see page A135).

② Minimum order quantity is one package of 100. Price each x 100 = total price.

Renewal Coils - A.C., Conventional Coil ❶

AC Control Voltages			AC Coil Codes	For use with contactor... CA6-95, CA6-110 CA6-115, CA6-140 CA(N)6-180	Optional RC Module ❷	Optional Varistor Module ❷
Conventional Coil						
50 Hz	60 Hz	50/60 Hz		Catalog No.	Catalog No.	Catalog No.
24V	~	~	24A	CA6-TG407	CRC6-48	CRV6-55
~	24V	~	24	CA6-TG013	CRC6-48	CRV6-55
32V	36V	~	~	CA6-TG481	CRC6-48	CRV6-55
42V	48V	~	48	CA6-TG482	CRC6-48	CRV6-55
48V	55V	~	48A	CA6-TG414	CRC6-48	CRV6-55
110V	120V	~	120B	CA6-TG473	CRC6-110	CRV6-136
~	208V	~	208	CA6-TG049	CRC6-240	CRV6-277
220-230V	240V	~	240B	CA6-TG441	CRC6-240	CRV6-277
240V	277V	~	277	CA6-TG480	CRC6-240	CRV6-277
380V-400V	440V	~	380	CA6-TG071	CRC6-880	CRV6-575
415V	480V	~	480	CA6-TG475	CRC6-550	CRV6-575
440V	508V	~	~	CA6-TG478	CRC6-550	CRV6-575
500V	575V	~	575	CA6-TG479	CRC6-550	CRV6-575
550V	600V	~	600	CA6-TG476	CRC6-550	CRV6-575
Price				184.89	See page A133 for pricing	

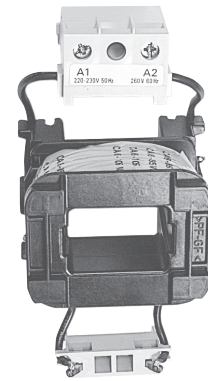

CA6 A.C. Coil (typical)

Renewal Coils - D.C., Conventional Two-Winding Coil ❶❸

DC Control Voltages	DC Coil codes	For use with contactor...	Factory Integrated Varistor built into coil
		CA6-95 CA6-110 CA6-115, CA6-140 CA(N)6-180	
Conventional Coil		Catalog No.	
12V	12D	CA6-TG708	Yes
24V	24D	CA6-TG714	Yes
48V	48D	CA6-TG724	Yes
110V	110D	CA6-TG733	Yes
125V	125D	CA6-TG737	Yes
220V	220D	CA6-TG761	Yes
240V	~	CA6-TG750	Yes
250V	250D	CA6-TG751	Yes
Price		257.59	

❶ Other coil voltages available. Contact your Sprecher + Schuh representative for information.

❷ Not factory installed, must be ordered separately.

❸ For conventional DC coils, the pickup winding must be connected to a NC late-break auxiliary contact. (See page A149)

Renewal Coils - A.C., “-EI” Electronic Coil ①③⑤

AC Control Voltages		AC Coil Codes ②	For use with contactor...				'EI' Coil Suppressor Info	
			CA6-95-EI CA6-110-EI CA6-115-EI CA6-140-EI CA6-180-EI CAN6-180-EI CA6-210-EI CA6-250-EI	CA6-300-EI CAN6-300-EI	CA6-420-EI	CA6-630-EI CA6-860-EI	Factory Integrated Suppressor on Coil Circuit Board ③	Factory Installed External Suppressor Module ④
EI Coil			Catalog No.	Catalog No.	Catalog No.	Catalog No.		Catalog No.
60 Hz	50/60 Hz							
~	24V	24	CA6-TGE855	CA6-TGE855	~	~	No	CRV6-40
~	42-64V	48	CA6-TGE864	CA6-TGE864	~	~	No	CRV6-75
~	110-130V	120	CA6-TGE865	CA6-TGE865	CA6-THE865	~	Yes	~
~	208-277V	220W	CA6-TGE866	CA6-TGE866	CA6-THE866	~	Yes	④
~	380-500V	460W	CA6-TGE867	CA6-TGE867	CA6-THE867 ⑥	~	Yes	RC 100N ⑤
~	110-130V	120	~	~	~	CA6-TJE865 ⑥	Yes	~
~	200-220V	208W	~	~	~	CA6-TJE878	Yes	~
~	230-250V	240W	~	~	~	CA6-TJE879 ⑥	Yes	~
~	277V	277	~	~	~	CA6-TJE880	Yes	~
~	380-415V	380	~	~	~	CA6-TJE867	Yes	~
~	440-480V	480	~	~	~	CA6-TJE868	Yes	~
Price			437.27	437.27	586.84	916.09		24.30

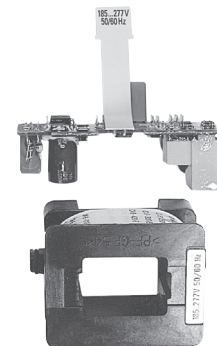

CA6 A.C. “-EI” coil (typical)

Renewal Coils - D.C., “-EI” Electronic Coil ①③④

DC Control Voltage		DC Coil Codes	For use with contactor...				'EI' Coil Suppressor Info	
			CA6-95-EI CA6-110-EI CA6-115-EI CA6-140-EI CA6-180-EI CAN6-180-EI CA6-210-EI CA6-250-EI	CA6-300-EI CAN6-300-EI	CA6-420-EI	CA6-630-EI CA6-860-EI	Factory Integrated Suppressor on Coil Circuit Board ③	Factory Installed External Suppressor Module ④
EI Coil			Catalog No.	Catalog No.	Catalog No.	Catalog No.		Catalog No.
24V ⑦		24D	CA6-TGE708	CA6-TGE708	~	~	No	CRV6-40
48-72V		48D	CA6-TGE779	CA6-TGE779	~	~	No	CRV6-55
110-130V		120D	CA6-TGE780	CA6-TGE780	CA6-THE780	~	Yes	~
200-255V		220D	CA6-TGE781	CA6-TGE781	CA6-THE781	~	Yes	~
110-130		120	~	~	~	CA6-TJE865 ⑥	Yes	~
200-255V		240W	~	~	~	CA6-TJE879 ⑥	Yes	~
Price			513.10	513.10	660.58	916.09		24.30

Items in grey are obsolete.

- ① Other coil voltages available. Contact your Sprecher + Schuh representative for more information.
- ② Coil Codes in bold letters and shaded indicate coils that are standard stocked items.
- ③ Factory external suppressor module provided where shown, included with replacement coil.
- ④ Factory integrated suppressor is overvoltage category III, for optional category IV, e.g. lightning protection, a CRV6-550 module can be added.
- ⑤ Special capacitor module supplied on CA6-420 only, not shown in catalog.
- ⑥ Coil is rated AC / DC.
- ⑦ Customers with 24VDC applications should strongly consider using the “EI” functionality of the CA6 (see page A148).
- ⑧ Contactor manufactured with 380-500V coils can not be interchanged with any other coils because of the circuit board built into the base of the CA6-420.

CA6 Contactors

Main Contact - 3 Per Set (up to CA6-420)

Main Contacts <i>(typical)</i>	For use with...	Catalog Number	Price/ Set
	CA6-95	CA6-C95	259.66
	CA6-95-EI	CA6-CE95	307.44
	CA6-110	CA6-C110	323.02
	CA6-110-EI	CA6-CE110	323.02
	CA6-115	CA6-C115	307.44
	CA6-115-EI	CA6-CE115	307.44
	CA6-140	CA6-C140	492.33
	CA6-140-EI	CA6-CE140	492.33
	CA(N)6-180	CA6-C180	586.84
	CA(N)6-180-EI	CA6-CE180	611.77
	CA6-210-EI	CA6-CE210	792.50
	CA6-250-EI	CA6-CE250	992.96
	CA(N)6-300-EI	CA6-CE300	1184.07
	CA6-420-EI	CA6-CE420	1703.40

Items in grey are obsolete and have limited availability.

Main Contact & Arc Chute - Complete Set (CA6-630 and CA6-860)

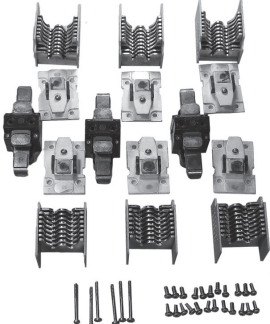
		
Complete set of three each Main Contact, Arc Chute and hardware		
For use with...	Catalog Number	Price/ Set
CA6-630-EI	CA6-CE-630 ④	3053.66
CA6-860-EI	CA6-CE-860 ④	4133.86

Standard Terminal Hardware (screw & washer) ①

Terminal Hardware	Fits Contactor...	Screw Type	Catalog Number	Price Each
	CA6-95 & 110	M6	CA6-HF110	28.77
	CA6-115(-EI), 140(-EI) & CA(N)6-180(-EI)	M8	CA6-HF180	43.42
	CA6-210-EI, CA6-250-EI, CA(N)6-300-EI & CA6-420-EI	M10	CA6-HF420	88.08
	CA6-630-EI to 860-EI	M12	CA6-HF860	132.95

Items in grey are obsolete and have limited availability.

Arc Chutes ②③

Arc Chutes <i>(typical)</i>	For use with...	Catalog Number	Price/ Set
	CA6-95	CA6-A95	128.80
	CA6-95-EI	CA6-AE95	128.80
	CA6-110	CA6-A110	173.45
	CA6-110-EI	CA6-AE110	173.45
	CA6-115	CA6-A115	166.19
	CA6-115-EI	CA6-AE115	166.19
	CA6-140	CA6-A140	194.23
	CA6-140-EI	CA6-AE140	213.96
	CA(N)6-180	CA6-A180	253.43
	CA(N)6-180-EI	CA6-AE180	253.43
	CA6-210-EI	CA6-AE210	473.63
	CA6-250-EI	CA6-AE250	564.00
	CA(N)6-300-EI	CA6-AE300	658.51
	CA6-420-EI	CA6-AE420	743.68

Items in grey are obsolete and have limited availability.

- ① Set of six (6). Priced per set.
- ② One (1) required per contactor.
- ③ CA6-...W Arc Chutes available by special order.
- ④ Kit includes Main Contacts and Arc Chute Chamber.

Contactors Cross Reference, Series CA1 & CA6 to Series CA9 (Open Type Only) ①

A
CA6 Contactors

I _e [A]		Ratings for Switching AC Motors (AC2 / AC3 / AC4)										Series CA1 Obsolete	Series CA6 Obsolete	Series CA9 Equivalent
		kW (50 Hz)				UL/CSA HP (60 Hz)								
		230V	400V/ 415V	500V	690V	1 Ø		3 Ø						
115V	230V					200V	230V	460V	575V					
AC-3	AC-1	230V	400V/ 415V	500V	690V	115V	230V	200V	230V	460V	575V	Catalog Number	Catalog Number	Catalog Number
115	250	37	64/66	80	111	10	25	40	40	75	100		CA6-115	
116	160	30	55	75	55			30	40	75	100			CA9-116
						10	25	40	40	75	100	CA1-60		
140	250	45	78/82	80	111	15	30	40	50	100	125		CA6-140	
146	225	45	75	90	90			40	50	100	125			CA9-146
						15	30	50	50	100	125	CA1-100		
180	250	57	101/105	98	135	~	40	50	60	150	150		CA6-180	
190	275	55	90	90	132			50	60	125	150			CA9-190
						~	~	60	60	150	150	CA1-150		
205	350	55	110	110	160			60	75	150	200			CA9-205
210	350	67	118/122	147	205	~	50	60	75	150	200		CA6-210	
						~	~	75	100	200	250	CA1-250		
250	350	80	140/145	177	250	~	~	75	100	200	250		CA6-250	
265	400	75	132	160	200			75	100	200	250			CA9-265
300	450	97	170/176	213	293	~	~	100	125	250	300		CA6-300	
305	500	90	160	200	250			100	125	250	300			CA9-305
						~	~	150	150	350	400	CA1-480		
400	600	110	200/220	250	315			125	150	350	400			CA9-400
420	500	135	238/250	298	424	~	~	150	175	350	400		CA6-420	
460	700	132	250	315	355			150	200	400	500			CA9-460
580	800	160	315/355	400	500			200	250	500	600			CA9-580
630	800	200	355	450	500	~	~	200	250	500	600		CA6-630	
750	1050	220	400/425	520	600			250	300	600	700			CA9-750
860	1000	250	500	560	~	~	~	250	300	600	700		CA6-860	
860	1350	257	475/500	560	800			~	400	800	1000			CA9-860

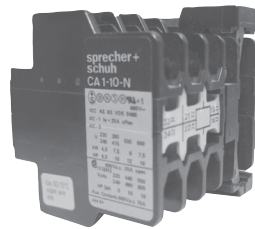

CA1-10
Contactor

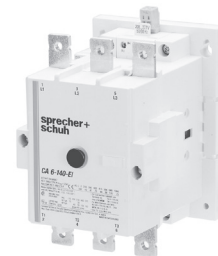

CA6-140-EI contactor

① Available auxiliary contacts may vary. See selection pages for more information.

Technical Information

	CA6-115(-EI)	CA6-140(-EI)	CA6-180(-EI)	CA6-210-EI	CA6-250-EI	CA6-300-EI	CA6-420-EI	CA6-630-EI	CA6-860-EI	
Rated Insulation Voltage U_i										
IEC, AS, BS, SEV, VDE 0660 [V]					1000V					
UL; CSA [V]					600V					
Rated Voltage U_{mp} (kV)	12kV									
Rated Voltage U_e - Main Contacts										
AC 50/60Hz [V]					230, 240, 400, 415, 500, 690, 1000V					
DC [V]					24, 48, 110, 220, 440V					
Operating Frequency for AC Loads [Hz]	50/60Hz									

Switching Motor Loads

Standard IEC Ratings

AC-2, AC-3			CA6-115(-EI)	CA6-140(-EI)	CA6-180(-EI)	CA6-210-EI	CA6-250-EI	CA6-300-EI	CA6-420-EI	CA6-630-EI	CA6-860-EI	
DOL & Reversing 50Hz	230V [A]		115	140	180	210	250	300	420	630	860	
	240V [A]		115	140	180	210	250	300	420	630	860	
	400V [A]		115	140	180	210	250	300	420	630	860	
	415V [A]		115(130)①	140(155)①	180(189)③	210(227)①	250(258)①	300(315)①	420	630	860	
	500V [A]		115	115/140②	140(180)①	210	250	300	420	630	753	
	690V [A]		115	115/140②	140(180)①	210	250	300	420	492	~	
	1000V [A]		46	55	65	80	95	115	160	~	~	
	230V [kW]		37	45	57	67	80	97	135	200	250	
	240V [kW]		38	47	60	70	83	101	141	200	250	
	400V [kW]		64	78	101	118	140	170	238	355	500	
UL/CSA DOL & Reversing 1Ø 60Hz	415V [kW]		66(75)①	82(90)①	105(110)①	122(132)①	145(150)①	176(185)①	250	355	500	
	500V [kW]		80	80(98)②	98(126)①	147	177	213	298	450	560	
	600V [kW]		111	111/135②	135(176)①	205	250	293	424	500	~	
	1000V [kW]		63	75	90	110	132	160	225	~	~	
	115V [A]		100	135	~	~	~	~	~	~	~	
	230V [A]		110	136	176	216	~	~	~	~	~	
	115 V [HP]		10	15	~	~	~	~	~	~	~	
	230 V [HP]		25	30	40	50	~	~	~	~	~	
	200V [A]		120	120	150	177	221	285	414	552	692	
	230 V [A]		104	130	154	192	248	312	420	602	720	
3Ø	460 V [A]		96	124	180	180	240	302	414	590	702	
	575 V [A]		99	125	144	192	242	289	382	562	651	
	200 V [HP]		40	40	50	60	75	100	150	200	250	
	230 V [HP]		40	50	60	75	100	125	175	250	300	
	460 V [HP]		75	100	150	150	200	250	350	500	600	
	575 V [HP]		100	125	150	200	250	300	400	600	700	
	AC4 (200,000 Op. Cycles) 50Hz	230V [A]		53	60	67	85	105	140	170	~	~
		240V [A]		53	60	67	85	105	140	170	~	~
400/415V [A]			53	60	67	85	105	140	170	~	~	
500V [A]			53	60	67	85	105	140	170	~	~	
690V [A]			53	60	67	85	105	140	170	~	~	
1000V [A]			25	37	43	60	72	85	105	~	~	
230V [kW]			15	17	20	25	32	45	55	~	~	
240V [kW]			15	18.5	22	25	32	45	55	~	~	
400/415V [kW]			25	32	37	45 / 50	55	75 / 80	90 / 100	~	~	
500V [kW]			32	40	45	55	75	100	110	~	~	
690V [kW]			45	55	63	80	100	132	160	~	~	
1000V [kW]			30	50	55	80	100	110	150	~	~	
Max. Operating Rate [ops/hr]		120	120	100	120	100	70	70	~	~		

① Values in () represent ratings for AC-2 & AC-3 and result in reduced lifespan of 25%. Use 400V values for full life span.

② Second number is rating for the "-EI" model.

Electrical Data

			CA6-115(-EI)	CA6-140(-EI)	CA6-180(-EI)	CA6-210-EI	CA6-250-EI	CA6-300-EI	CA6-420-EI	CA6-630-EI	CA6-860-EI
Switching Motor Loads (continued)											
Wye-Delta (Star Delta)											
50Hz											
230V	[A]		199	242	312	364	433	520	727	~	~
240V	[A]		199	242	312	364	433	520	727	~	~
400V	[A]		199	242	312	364	433	520	727	~	~
415V	[A]		199(225)	242(268)①	312(332)	364(393)①	433(447)①	520(546)①	727	~	~
500V	[A]		199	199 / 242②	312	364	433	520	727	~	~
690V	[A]		199	199 / 242②	312	364	433	520	727	~	~
1000V	[A]		80	95	113	139	165	200	277	~	~
230V	[kW]		63	75	90	110	132	160	220	~	~
240V	[kW]		66	80	100	125	150	160	250	~	~
400V	[kW]		110	132	160	200	250	300	425	~	~
415V	[kW]		114(132)①	132(160)①	160	220	250	315(335)①	425①	~	~
500V	[kW]		132	132 / 160②	200	250	315	375	530	~	~
690V	[kW]		192	200 / 220②	300	355	425	530	750	~	~
1000V	[kW]		100	132	160	200	220	280	400	~	~
60 Hz											
200V	[HP]		60	60	75	100	125	175	250	~	~
230V	[HP]		60	75	100	125	175	200	250	~	~
460V	[HP]		125	175	200	250	350	450	600	~	~
575V	[HP]		150	200	250	300	450	500	650	~	~
UL/GSA Elevator Duty											
200V	[A]		78	92	120	150	150	177	221	~	~
230V	[A]		80	104	130	130	154	192	248	~	~
460V	[A]		77	96	124	156	180	180	240	~	~
575V	[A]		77	77	99	125	144	192	242	~	~
200V	[HP]		25	30	40	50	50	60	75	~	~
230V	[HP]		30	40	50	50	60	75	100	~	~
460V	[HP]		60	75	100	125	150	150	200	~	~
575V	[HP]		75	75	100	125	150	200	250	~	~
AC-1 Load, 3Ø Switching											
Ambient Temperature 40°C											
I_{th}	[A]		250	250	250	350	350	450	540	800	1000
230V	[kW]		100	100	100	139	139	179	199	319	398
240V	[kW]		104	104	104	145	145	187	208	333	416
400V	[kW]		173	173	173	242	242	312	346	554	693
415V	[kW]		180	180	180	252	252	323	359	575	719
500V	[kW]		217	217	217	303	303	390	433	693	866
690V	[kW]		299	299	299	418	418	538	598	956	1195
1000V	[kW]		433	433	433	606	606	779	866	~	~
Ambient Temperature 60°C											
I_{th}	[A]		210	210	210	300	300	380	425	~	~
230V	[kW]		84	84	84	120	120	151	169	~	~
240V	[kW]		87	87	87	125	125	158	177	~	~
400V	[kW]		145	145	145	208	208	263	294	~	~
415V	[kW]		151	151	151	216	216	273	305	~	~
500V	[kW]		182	182	182	260	260	329	368	~	~
690V	[kW]		251	251	251	359	359	454	508	~	~
1000V	[kW]		364	364	364	520	520	658	736	~	~

① Values in () represent ratings for AC3 & AC4 and result in reduced lifespan of 25%.

Use 400V values for full life span.

② Rating CA6-140 / CA6-140-EI.

Electrical Data

			CA6-115(-EI)	CA6-140(-EI)	CA6-180(-EI)	CA6-210-EI	CA6-250-EI	CA6-300-EI	CA6-420-EI	CA6-630-EI	CA6-860-EI	
Continuous Current (UL/CSA)												
General Purpose Rating (40°C)	Open	[A]	250	250	250	350	350	420	500	760	1000	
	Enclosed	[A]	220	220	220	300	300	340	420	630	860	
Lighting Loads												
Elect.Dischrg.Lamps-AC-5a, single compensated	Open	[A]	144	225	225	315	315	405	450	~	~	
	Enclosed	[A]	122	189	189	270	270	342	383	~	~	
Incandescent Lamps - AC-5b		[A]	120	140	170	210	250	300	420	~	~	
Switching power transformers AC-6a												
Inrush												
Rated transformer current, P_e												
n=30	240VAC	[A]	60	70	85	105	125	150	210	~	~	
	230 VAC	[kVA]	24	28	34	42	50	60	84	~	~	
	240 VAC	[kVA]	26	29	35	44	52	62	87	~	~	
	400 VAC	[kVA]	42	48	59	73	87	104	145	~	~	
	415 VAC	[kVA]	43	50	61	75	90	108	151	~	~	
	500 VAC	[kVA]	52	61	74	91	108	130	182	~	~	
	690 VAC	[kVA]	72	84	102	125	149	179	251	~	~	
	1000 VAC	[kVA]	80	121	147	182	217	260	364	~	~	
	n = 20	690 VAC	[A]	90	105	128	158	188	225	315	~	~
	n = 15	690 VAC	[A]	120	140	170	210	250	300	420	~	~
60Hz Peak inrush/peak rated transformer												
n = 30		[A]	60	70	85	105	125	150	210	~	~	
	200V	[kVA]	20.8	24.2	29.4	36.4	43.3	52.0	72.7	~	~	
	208V	[kVA]	21.6	25.2	30.6	37.8	45.0	54.0	75.7	~	~	
	240V	[kVA]	24.9	29.1	35.3	43.6	52.0	62.4	87.3	~	~	
	480V	[kVA]	49.9	58.2	70.7	87.3	104	125	175	~	~	
	600V	[kVA]	62.4	72.7	88.3	109	130	156	218	~	~	
	660V	[kVA]	68.6	80.0	97.2	120	143	171	240	~	~	
60Hz Peak inrush/peak rated transformer												
n = 20		[A]	90	105	128	158	188	225	315	~	~	
	200V	[kVA]	31.2	36.4	44.3	54.7	65.1	77.9	109	~	~	
	208V	[kVA]	32.4	37.8	46.1	56.9	67.7	81.1	113	~	~	
	240V	[kVA]	37.4	43.6	53.2	65.7	78.2	93.5	131	~	~	
	480V	[kVA]	74.8	87.3	106	131	156	187	262	~	~	
	600V	[kVA]	93.5	109	133	164	195	234	327	~	~	
	660V	[kVA]	103	120	146	181	215	257	360	~	~	
60Hz Peak inrush/peak rated transformer												
n = 15		[A]	120	140	170	210	250	300	420	~	~	
	200V	[kVA]	41.6	48.5	58.9	72.7	86.6	104	145	~	~	
	208V	[kVA]	43.2	50.4	61.2	75.7	90.1	108	151	~	~	
	240V	[kVA]	49.9	58.2	70.7	87.3	104	125	175	~	~	
	480V	[kVA]	99.8	116	141	175	208	249	349	~	~	
	600V	[kVA]	125	145	177	218	260	312	436	~	~	
	660V	[kVA]	137	160	194	240	286	343	480	~	~	

Electrical Data

			CA6-115(-EI)	CA6-140(-EI)	CA6-180(-EI)	CA6-210-EI	CA6-250-EI	CA6-300-EI	CA6-420-EI	CA6-630(EI)	CA6-860-EI	
DC Ratings												
DC-1 Rating at 60°C												
1 Pole	Non-inductive or slightly inductive loads, resistive furnaces	24VDC	[A]	135	210	210	300	300	380	425	~	~
		48VDC	[A]	135	210	210	300	300	380	425	~	~
		110VDC	[A]	135	210	210	300	300	380	425	~	~
		220VDC	[A]	3	3.3	3.3	4.9	4.9	4.9	5.2	~	~
		440VDC	[A]	0.6	0.75	0.75	1	1	1	1.2	~	~
2 Poles in Series		24VDC	[A]	135	210	210	300	300	380	425	~	~
		48VDC	[A]	135	210	210	300	300	380	425	~	~
		110VDC	[A]	135	210	210	300	300	380	425	~	~
		220VDC	[A]	135	210	210	300	300	380	425	~	~
		440VDC	[A]	3	3.3	3.3	4.9	4.9	4.9	5.2	~	~
3 Poles in Series ❶		24VDC	[A]	135	210	210	300	300	380	425	~	~
		48VDC	[A]	135	210	210	300	300	380	425	~	~
		110VDC	[A]	135	210	210	300	300	380	425	~	~
		220VDC	[A]	135	210	210	300	300	380	425	~	~
		440VDC	[A]	11	11	11	14	14	14	15	~	~
DC-3 Rating at 60°C												
3 Poles in Series ❶	Shunt wound motors - Starting, reverse current breaking, reversing, stepping	24VDC	[A]	135	210	210	300	300	380	425	~	~
		48VDC	[A]	135	210	210	300	300	380	425	~	~
		110VDC	[A]	135	210	210	300	300	380	425	~	~
		220VDC	[A]	135	210	210	300	300	380	425	~	~
	440VDC	[A]	3	3.5	3.5	4.1	4.1	4.1	5.8	~	~	
DC-5 Rating at 60°C												
3 Poles in Series ❶	Series wound motors - Starting, reverse current breaking, reversing, stepping	24VDC	[A]	135	210	210	300	300	380	425	~	~
		48VDC	[A]	135	210	210	300	300	380	425	~	~
		110VDC	[A]	135	210	210	300	300	380	425	~	~
		220VDC	[A]	135	210	210	300	300	380	425	~	~
	440VDC	[A]	1.2	2.1	2.1	2.4	2.4	2.4	3.0	~	~	

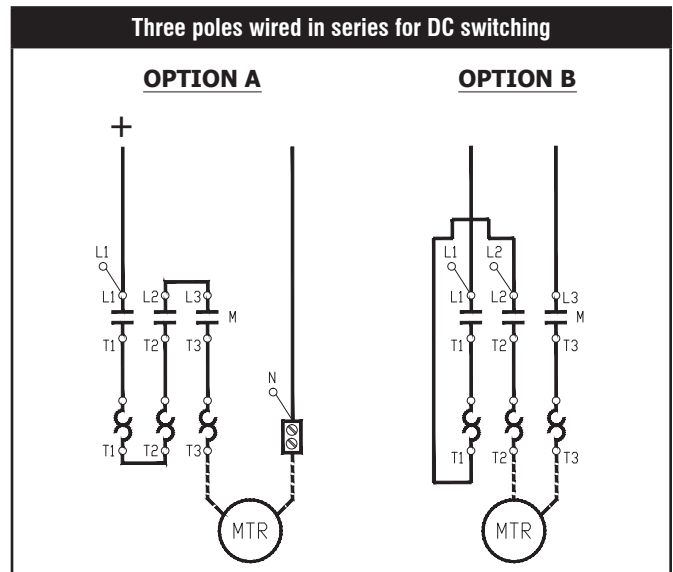

❶ See diagram to right for three poles wired in series for DC switching

Electrical Data

			CA6-115(-EI)	CA6-140(-EI)	CA6-180(-EI)	CA6-210(-EI)	CA6-250(-EI)	CA6-300(-EI)	CA6-420(-EI)	CA6-630(-EI)	CA6-860(-EI)
Capacitor Ratings AC-6b											
Capacitor Switching - 50Hz											
Single Capacitor - 40°C	230 V	[kVar]	45	70	70	98	98	125	139	~	~
	240 V	[kVar]	47	73	73	102	102	131	145	~	~
	400 V	[kVar]	78	121	121	170	170	218	242	~	~
	415 V	[kVar]	81	126	126	176	176	226	252	~	~
	500 V	[kVar]	97	152	152	212	212	273	303	~	~
	690V	[kVar]	134	209	209	293	293	376	418	~	~
	1000 V	[kVar]	194	303	303	424	424	546	606	~	~
Single Capacitor - 60°C	230 V	[kVar]	38	59	59	84	84	106	119	~	~
	240 V	[kVar]	39	61	61	87	87	111	124	~	~
	400 V	[kVar]	65	102	102	145	145	184	206	~	~
	415 V	[kVar]	68	106	106	151	151	191	214	~	~
	500 V	[kVar]	82	127	127	182	182	230	258	~	~
	690V	[kVar]	113	176	176	251	251	318	356	~	~
	1000 V	[kVar]	164	255	255	364	364	461	515	~	~
Capacitor Bank- 40°C	230 V	[kVar]	45	70	70	98	98	125	139	~	~
	240 V	[kVar]	47	73	73	102	102	131	145	~	~
	400 V	[kVar]	56	76	111	170	170	218	242	~	~
	415 V	[kVar]	56	76	112	170	176	226	252	~	~
	500 V	[kVar]	56	76	113	172	212	273	303	~	~
	690V	[kVar]	57	78	114	174	247	356	418	~	~
	1000 V	[kVar]	58	79	116	177	251	361	606	~	~
Capacitor Bank- 60°C	230 V	[kVar]	38	59	59	84	84	106	119	~	~
	240 V	[kVar]	39	61	61	87	87	111	124	~	~
	400 V	[kVar]	56	76	102	145	145	184	206	~	~
	415 V	[kVar]	56	76	106	151	151	191	214	~	~
	500 V	[kVar]	56	76	113	172	182	230	258	~	~
	690V	[kVar]	57	78	114	174	247	318	356	~	~
	1000 V	[kVar]	58	79	116	177	251	361	515	~	~
Capacitor Switching - 60Hz											
Single Capacitor - 40°C	200 V	[kVar]	39	61	61	85	85	109	121	~	~
	230 V	[kVar]	45	70	70	98	98	125	133	~	~
	460 V	[kVar]	89	139	139	195	195	251	279	~	~
	600V	[kVar]	116	182	182	255	255	327	364	~	~
Capacitor Bank- 40°C	200 V	[kVar]	39	61	61	85	85	109	121	~	~
	230 V	[kVar]	45	70	70	98	98	125	139	~	~
	460 V	[kVar]	56	76	112	171	195	251	279	~	~
	600V	[kVar]	57	77	114	173	246	327	364	~	~

Electrical Data

		CA6-115(-EI)	CA6-140(-EI)	CA6-180(-EI)	CA6-210-EI	CA6-250-EI	CA6-300-EI	CA6-420-EI	CA6-630-EI	CA6-860-EI	
Short-Circuit Coordination											
Contactors without Motor Protection Relays											
DIn Fuses - gG, gL											
Available Fault Current	[A]	100 KA	100 KA	100 KA	100 KA	100 KA	100 KA	100 KA	~	~	
Type "1"	[A]	250	315	315(355)	500	500	630	630	①	①	
Type "2" (380/400/415/690V) ④	[A]	200	250	250(315)	400	400	500	500			
Type "2" (1000V) ④	[A]	200	250	250(315)	400	400	500	500			
cUL Short-Circuit Ratings											
Class K1, RK1, K5, and RK5 Fuses (L Fuses)											
Available Fault Current	[A]	10 KA	10 KA	10 KA	10 KA	18 KA	18 KA	18 KA	30 KA	42 KA	
cUL Max. Rating (600V) ⑤ Type 1	[A]	250	350	450	500	L-700	L-700	L-1000	L-2000	L-2500	
Class J CSA & HRCI-J Fuses ②											
Available Fault Current	[A]	100 KA	100 KA	100 KA	100 KA	100 KA	100 KA	100 KA	~	~	
cUL Max. Rating (600V) ⑤ Type 2	[A]	200	250	300	400	400	500	600	~	~	
Circuit Breaker, inverse time ⑤											
Available Fault Current	[A]	10 KA	10 KA	10 KA	10 KA	18 KA	18 KA	18 KA	30 KA	42 KA	
cUL Max. Rating (600V) ⑤ Type 1	[A]	150	200	250	300	350	400	500	1200	1200	
Short Time Current Withstand Ratings											
I_{cw} 60° C	1 S	[A]	1800	1800(2550) ②	2550	3405	3870	4725	6376	①	①
	4 S	[A]	1500	1800(1970) ②	1970	3150	3870	4100	6376		
	10 S	[A]	1040	1240(1360) ②	1480	2360	2520	2840	4700	6300	7000
	15 S	[A]	860	860 (1130) ②	1130	2000	2110	2270	3460		
	60 S	[A]	650	650 (850) ②	850	1215	1300	1500	1880	①	①
	240 S	[A]	340	340 (600) ②	600	705	750	840	1280		
900 S	[A]	240	250 (440) ②	440	460	500	590	840			
Off Time Between Operations	[Min.]	20	20	20	30	30	30	30			
Resistance and Watt Loss I_e AC3											
Resistance per power pole	[mW]	0.4	0.42	0.42	0.22	0.22	0.18	0.15	0.19	0.14	
Watt Loss - 3 power poles	[W]	14.5	24.6	40.8	29.4	41.7	48.6	79.4	226.2	310.6	
Coil and 3 power poles (@ I_{eAC3})	AC	[W]	24.5(20.5) ②	34.6(30.6) ②	50.8(46.8) ②	35.4	47.7	54.6	86.5	256.2	340.6
	DC	[W]	22.5(20.5) ②	32.6(30.6) ②	48.8(46.8) ②	35.4	47.7	54.6	86.5	256.2	340.6

① Under test. Contact your Sprecher + Schuh representative.
 ② Values in parentheses () are for the -EI- contactor.
 ③ UL Listed Combination. (UL File E41850) Per UL508A, NEC409 and CSA 22.2 No.14 for contactor and fuses or circuit breaker only.
 ④ Per IEC 60947-1 for contactor and fuses only.
 ⑤ When used as a Branch Circuit Protection device, NEC 430-152 defines the maximum rating of an Inverse-time circuit breaker to be sized at 250% of the motor nameplate FLA for most applications.

A
CA6 Contactors

Short Circuit Ratings

High Fault Short Circuit Ratings per UL508 and CSA 22.2 No.14

			Fuse Ratings			UL Listed Circuit Breaker Ratings ①			
CEP7 Second Generation Cat. No.	Contactors Catalog No.	Max. starter FLC (A)	Max. available fault current (kA)	Max. voltage (V)	UL Class J and CSA HRCI-J fuse (A)	Short Circuit Rating (kA)	Max. Voltage (V)	Max. CB rating (A)	
CEP7	EEHF	CA6-115 CAN6-115	115	100	600	200	65 25	480 600	250
		CA6-140	140			250			
	EEJF	CA6-180 CAN6-180	180	100	600	300	65 25	480 600	250
		EEJG	CA6-210	210	100	600	400	65 30	480 600
	CA6-250		250	400					
	CA6-300 CAN6-300		300	500					
	EEKG	CA6-210	210	100	600	400	65 30	480 600	400
		CA6-250	250			400			
		CA6-300 CAN6-300	300			500			
	EELG	CA6-420	420	100	600	600	42 25	480 600	600

① Various Mfg. of UL Listed Circuit Breakers may be used.

Mechanical Data

			CA6-115	CA6-115-EI	CA6-140(-EI)	CA6-180(-EI)	CA6-210-EI	CA6-250-EI	CA6-300-EI	CA6-420-EI	CA6-630-EI	CA6-860-EI	
Service Life	Mechanical	AC	[Mil.]	10	10	10	10	10	10	10	2	2	
		DC	[Mil.]	10	10	10	10	10	10	10	2	2	
	Electrical	AC-3 (400V)	[Mil.]	1	1	1	1	1	1	1	R/F	R/F	
Shipping Weights	AC - CA6		[kg]	3.3	3.8	3.3 (3.8)	3.3 (3.8)	7.5	7.5	7.5	7.5	28.6	28.6
			[Lbs]	7.3	8.38	7.3 (8.4)	7.3 (8.4)	16.5	16.5	16.5	16.5	63	63
	DC - CA6		[kg]	3.3	3.8	3.3 (3.8)	3.3 (3.8)	7.5	7.5	7.5	7.5	28.6	28.6
			[Lbs]	7.28	8.38	7.3 (8.4)	7.3 (8.4)	16.5	16.5	16.5	16.5	63	63

Terminations - Power

Type



Direct Connection

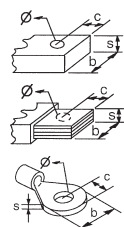

			25	30	52
b max.	[mm]		25	30	52
c max.	[mm]		12.5	15	22
s max.	[mm]		5	6	2 x 8
Ø min.	[mm]		8.3	10.5	13
Recommended Torque	[Nm]		22	43	68
	[Lb-in]		195	380	600

With Main Terminal Set (CA6-HB...)

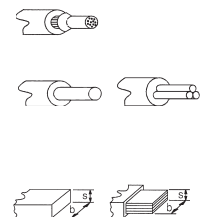

	sm. opening	[mm ²]	16...35	25...185	~
	lg. opening	[mm ²]	16...95	25...185	~
	sm. opening	[mm ²]	16...50	25...240	~
	lg. opening	[mm ²]	16...120	25...240	~
	b max.	[mm]	20	25	~
	s. sm. opening	[mm]	3...9	6...20	~
	s. lg. opening	[mm]	3...14	6...20	~
	Recommended Torque	[Nm]	14	25	~
Wire Size per UL/CSA	sm. opening	[AWG]	#6...1 / 0	#4...600MCM	~
	lg. opening	[AWG]	#6...250MCM	#4...600MCM	~
Recommended Torque	[Lb-in]		124	220	~

Minimum 25mm² (#4 AWG) -95mm² (250mcm) with sleeve per DIN 46228.

Mechanical Data (continued)

		CA6-115(-EI)	CA6-140(-EI)	CA6-180(-EI)	CA6-210(-EI)	CA6-250(-EI)	CA6-300(-EI)	CA6-420(-EI)	CA6-630(-EI)	CA6-860(-EI)
With Screw-type Lugs - Copper Clad (CA6-L...)										
Screw-type lugs accept round conductors only										
CA6-L180	[AWG]	#6...300 MCM			~			~	~	~
Recommended Torque	[Lb-in]	88...106			~			~	~	~
CA6-L420	[AWG]	~			2x #4...350 MCM			~	~	~
Recommended Torque	[Lb-in]	~			375			~	~	~
CA6-L630	[AWG]	~			~			2 x 2 / 0... 500 MCM	~	~
Recommended Torque	[Lb-in]	~			~			400	~	~
CA6-L860	[AWG]	~			~			~	4 x 2 / 0... 500 MCM	~
Recommended Torque	[Lb-in]	~			~			~	400	~

Terminations - Control

Description	 Combination Screw Head: Cross, Slotted, Pozidrive									
Coils										
Wires	1 or 2	[mm ²]					1...2.5			
		[AWG]					16...12			
Torque Requirement		[Nm]					1...1.5			
		[Lb-in]					8.9...13			
Control Modules										
Wires	1	[mm ²]					1...4			
		[AWG]					16...12			
Degree of Protection - contactor	IP00 per IEC 60529 and DIN 40 050									
Type of Protection - with accessories										
Single contactor cover	IP1X per IEC 60529 and DIN 40 050									
With main terminal set	IP2X per IEC 60529 and DIN 40 050									
Protection against accidental contact	Finger and back-of-hand proof according to VDE 0106, Part 100									

Coil Data

			CA6-115...180	CA6-115-EI...300-EI	CA6-420-EI	CA6-630-EI...860-EI
			Conventional Coil	"EI" Coil	"EI" Coil	"EI" Coil
Voltage Range	AC: 50Hz, 60Hz, 50/60 Hz	Pickup [x Us]	0.85...1.1	0.85 Us min...1.1 Us max	0.85 Us min...1.1 Us max	0.80 Us min...1.1 Us max
		Dropout [x Us]	0.3...0.6	0.3 Us min...0.5 Us max	0.3 Us min...0.5 Us max	0.1 Us min...0.8 Us max
DC		Pickup [x Us]	0.85...1.1	0.85 Us min...1.1 Us max	0.85 Us min...1.1 Us max	0.85 Us min...1.1 Us max
		Dropout [x Us]	0.30...0.6	0.3 Us min...0.5 Us max	0.3 Us min...0.5 Us max	0.1 Us min...0.8 Us max
Coil Consumption						
AC: 50Hz, 60Hz, 50/60 Hz	Pickup	[VA/W]	650 / 310	380 / 240 Ⓣ	490 / 270 Ⓣ	1915 / 1720
	Hold-in	[VA/W]	50 / 10	13 / 6	18 / 7	33 / 30
DC	Pickup	[W]	540 Ⓣ②	265 Ⓣ③	340 Ⓣ③	1980 Ⓣ③
	Hold-in	[W]	8	6	7	30
EI (B1-B2 24VDC Interface)		[VA/W]	~	15 ma	15 ma	15 ma
Operating Times						
AC: 50Hz, 60Hz, 50/60 Hz	Pickup	[ms]	20...47	20...45	20...45	60...100
	Dropout	[ms]	6...12	25...110	25...110	70...145
with RC Suppressor	Dropout	[ms]	9...18	~	~	~
DC	Pickup	[ms]	27...47	25...50	25...50	60...100
	with Integ. Suppression	Dropout	[ms]	12...20	35...110	35...110
Insulation Class			Class "B" according to VDE 0660, Table 22			

CA6-EI Application Notes for 24 volt AC/DC Electronic Coils

The CA6-EI 24 VAC or 24 VDC electronic coils are sensitive to voltage drops. These notes are provided to assist customers in control wiring methods and the selection of a power supply.

< 10ms	$I_{peak} = 25$ amps	Start-up peak
< 100ms	$I_{mean} = 11$ amps	Pull-in values
> 100ms	$I_{hold} = 0.5$ amps	Average Hold-in values

Circuit operation

- While the electronic coil is switching on, the power supply must deliver a peak of 25 amps. This period will not exceed 10ms.
- During the contactor closing period, the pull-in current of the coil drops to 11 amps. This period will not exceed 100ms.
- After approximately 80ms the demand of the electronic coil will be reduced to the holding value; which has an average of 0.5 amps.

Power supply selection

- Use peak value (I_{peak}) for the selection of the power supply.
- A regulated power supply is preferred.
- If an unregulated power supply is utilized then the no load value of the power supply must be less than 28 volts. Additional attention must be given to decrease the control wire resistance because unregulated power supplies have a high ripple voltage.

Control Circuit Wiring

To minimize wire resistance see the following:

- The wire gauge (cross-section) must be sufficient to allow a wire resistance of less than 150 milli-ohms for a regulated power supply and 100 milli-ohms for an unregulated power supply. For unregulated power supplies, 16 AWG can be used for runs up to 25 feet (longer for regulated power supply). Consult Sprecher + Schuh for additional information if longer runs are required.
- Stranded wire should be fitted with ferrules.
- Terminations should be tightened within the recommended torque values.
- If multiple CA6-EI contactors are used in the control circuit, the electronic coil terminations should be fed directly from the power supply (home runs). Do NOT parallel (jumper) multiple coil terminations. Switching of the home runs must be accomplished through separate (individual) contacts of a control relay or control device.

A Recommendation

A CA6 contactor used in the "EI" mode removes the burden of the coil from the 24 VDC power supply. The integrated electronic interface allows line voltage, or at least a higher AC voltage (i.e., 120V), to be applied to coil terminals A1 – A2, while the 24 VDC low level milli-ampere signal switches the B1 – B2 interface. The "EI" mode (method) has significant advantages over direct coil switching at 24 VDC. See the description of operation on the next page.

① Customers with 24VDC applications should strongly consider using the "EI" functionality of the CA6 (see pages A148-A149).

② Conventional DC coils are Two-Winding Coils. See page A149.

③ Electronic coil drives are designed to minimize power requirements, but this control may exhibit higher inrush (540W, <10ms) when energizing. This must be taken into account for the proper sizing of supply devices, all-or-nothing relays, and cross-sections of coil supply lines.

A CA6 Electronic Coils (CA6-115-EI...CA6-860-EI)

CA6 Contactors

CA6-EI contactors are supplied with an electronically controlled mechanism, which has an integrated electronic interface that consists of the following main parts:

- The coil bobbin rated for the control voltage.
- A printed circuit board with components for control and interface functions which is matched to the coil and rated for the control voltage.
- An interconnecting printed circuit board with coil terminals, which is located in the contactor base.
- R/C transient surge suppressors which are installed on the printed circuit board.

The CA6-EI coil bobbin and printed circuit board are a matched set; therefore, both must be changed when replacing the coil or changing out the coil to a different voltage. All replacement coils include both the coil bobbin and printed circuit board.

Commissioning

The CA6-EI contactor is operated in either the “E” mode (normal operation) or the “EI” mode (electronic interface operation) and is programmed by an orange “jumper” located on the bottom side of the contactor (opposite the coil terminals). This orange jumper is directly underneath main terminal T2 and is exposed by removing the small plastic cover that shields the mating space for the CRC/CRV protec-

tion element.

Electronic Operation – “E” Mode

For the “E” mode (factory default setting), the contactor is connected and controlled using terminals A1 & A2 in the same manner as a traditional contactor with an electromechanical coil mechanism. The contactor is programmed from the factory in the “E” mode by means of the orange jumper in the position as shown in Detail A. The “E” mode (or electronic mode) provides electronic control of the coil mechanism, but does not allow coil energizing from a low level signal source such as a PLC.

Electronic Interface Operation – “EI” Mode

For the “EI” mode, or optional electronic interface setting, the contactor can be switched from a PLC or other low-level signal source (13...30.2 VDC) without the need for an interposing relay. The contactor is programmed for the “EI” mode by moving the orange jumper to the position as shown in Detail B.

In the “EI” mode, the control voltage (VAC or VDC) must be permanently switched on to terminals A1 & A2 while in operation. The control signal from the PLC or other low-level signal source must be applied to terminals B1 & B2 (orange terminals) of the electronic interface in order to energize the contactor. The current burden of the interface is 15mA maximum.

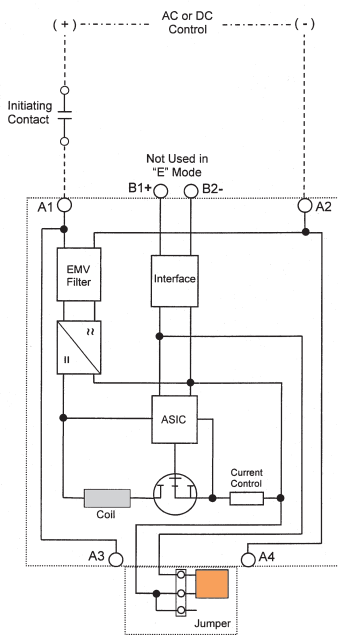

“E” Mode or Normal Operation Detail-A

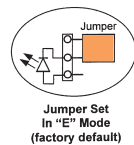

Jumper Set In “E” Mode (factory default)

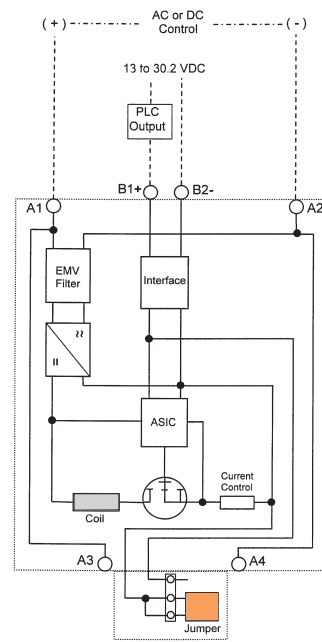

“EI” Mode or Interface Operation Detail-B

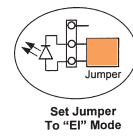

Set Jumper To “EI” Mode

CA6 Conventional DC Coil (CA6-115...CA6-180)

Conventional 3-lead DC Coil

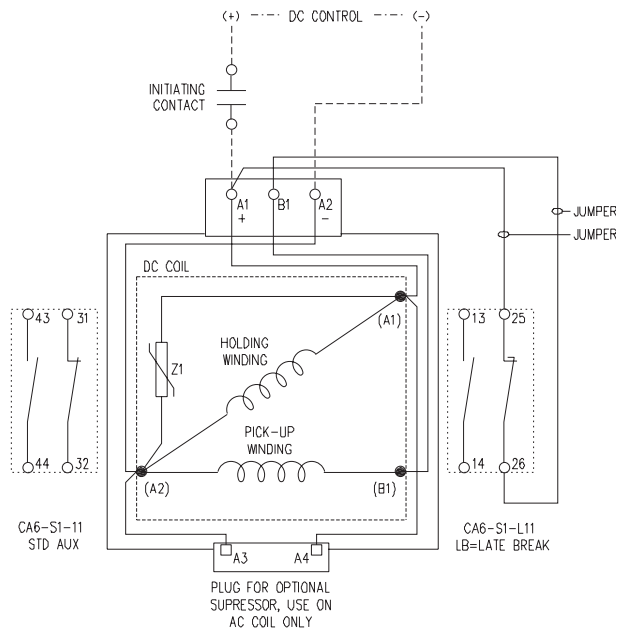





Notes

- 1) The CA6 conventional DC coil has dual windings with three leads brought out. One winding is the "pick-up" winding and the other is the "holding" winding. The coil also has a built-in voltage limiting varistor (Z1).
- 2) The pick-up winding has low resistance while the holding winding has a higher resistance.
- 3) When the control circuit is energized, the contactor "pulls-in" through the lower resistance pick-up winding and the NC late break auxiliary contact. After the contactor seals in, the late break contact opens and the contactor is held in through the holding winding.
- 4) The pick-up winding is not designed for continuous operation and must be disconnected by the "late break" contact immediately after the contactor pulls-in.

Environmental and General Specifications

	CA6-115(-EI)	CA6-140(-EI)	CA6-180(-EI)	CA6-210(-EI)	CA6-250(-EI)	CA6-300(-EI)	CA6-420(-EI)	CA6-630(-EI)	CA6-860(-EI)
Ambient Temperature ①									
Storage	-55...+80°C (-67...176°F)								
Operation at rated current	-25...+60°C (-13...140°F) (40°C per UL)								
Conditioned 15% current reduction	-70°C (158°F)								
Altitude at installed site	2000 meters above sea level per IEC 60947-1								
Resistance to Corrosion / Humidity	Damp-alternating climate: cyclic to IEC 68-2, 56 cycles. Dry heat: IEC 68-2, +100°C (212°F), relative humidity <50%, 7 days Damp tropical: IEC 68-2, +40°C (104°F), relative humidity <92%, 56 days.								
Shock Resistance	IEC 60068-2-27: Half sinusoidal shock 11 ms, 4g (12g in all three directions)								
Vibration Resistance	IEC 60068-2-6: Static >2g, in normal position								
Operating Position	See Dimensions pages								
Standards	IEC/EN 60947-1/-4-1/-5-1; UL508; CSA 22.2 No. 14								
Approvals	CE, cULus, CCC								

Auxiliary Contacts

		Conventional auxiliary contacts					Suitable for electronic circuits		
Switching, AC & DC Loads									
AC-1 I _{th}	at 40°C	[A]	16					0.1A at 250V	
	at 60°C	[A]	12					0.1A at 250V	
AC-15 at rated operating voltage of:		[V]	230	400	415	500	690		
		[A]	5.5	3	2.5	1.6	1	1...100mA at 3...125V	
DC-13, switching electromagnets at:		[V]	24	48	110	220	440		
		[A]	5	2	0.7	0.25	0.12	1...100mA at 3...125V	
Short Circuit Protection - gG Fuse									
Type 2 Coordination		[A]	16					0.1	
Rated Impulse Voltage U _{imp}		[kV]	8					1.5	
Load carrying capacity per UL/CSA									
Rated Voltage		[V]	600 max.					250V max.	
Continuous Rating		[A]	10 general purpose						
Switching Capacity			Heavy pilot duty (A600)					0.1A	
Rated Voltage		[V]	600 max.						
Switching Capacity			Standard pilot duty (P600)						
Minimum Switching Capacity			17V, 10mA					17V, 5mA	
Terminals									
Terminal Type									
Maximum Wire Size per IEC 947-1			1...2.5					1...2.5	
 Flexible with Wire-End Ferrule	1 Conductor	[mm²]	1...4					1...4	
 Solid/Stranded-Conductor	2 Conductor	[mm²]	1...4					1...4	
	1 Conductor	[mm²]	1...4					1...4	
	2 Conductor	[mm²]	1...4					1...4	
Recommended Tightening Torque		[Nm]	1.4...2.3					1.4...2.3	
Max. Wire Size per UL/CSA		[AWG]	16...12					16...12	
Recommended Tightening Torque		[lb-in]	12...20					12...20	
Degree of Protection	IP2X per IEC 529 and DIN 40 050								

Contact Ratings (Per UL508/NEMA A600 & Q600)

Standard	Circuit Voltage	Make (Amps/VA)	Break (Amps/VA)	Continuous Amps
A600	120AC	60A/7200VA	6A/720VA	10
	240AC	30A/7200VA	3A/720VA	
	480AC	15A/7200VA	1.5/720VA	
	650AC	12A/7200VA	1.2/720VA	
Q600	125DC	0.55/69VA	0.55A/69VA	2.5
	250DC	0.27A/69VA	0.27A/69VA	
	600AC	0.1A/69VA	0.1A/69VA	

① Ambient is the temperature outside the enclosure.

Life-Load Curves

AC-1 / AC-3

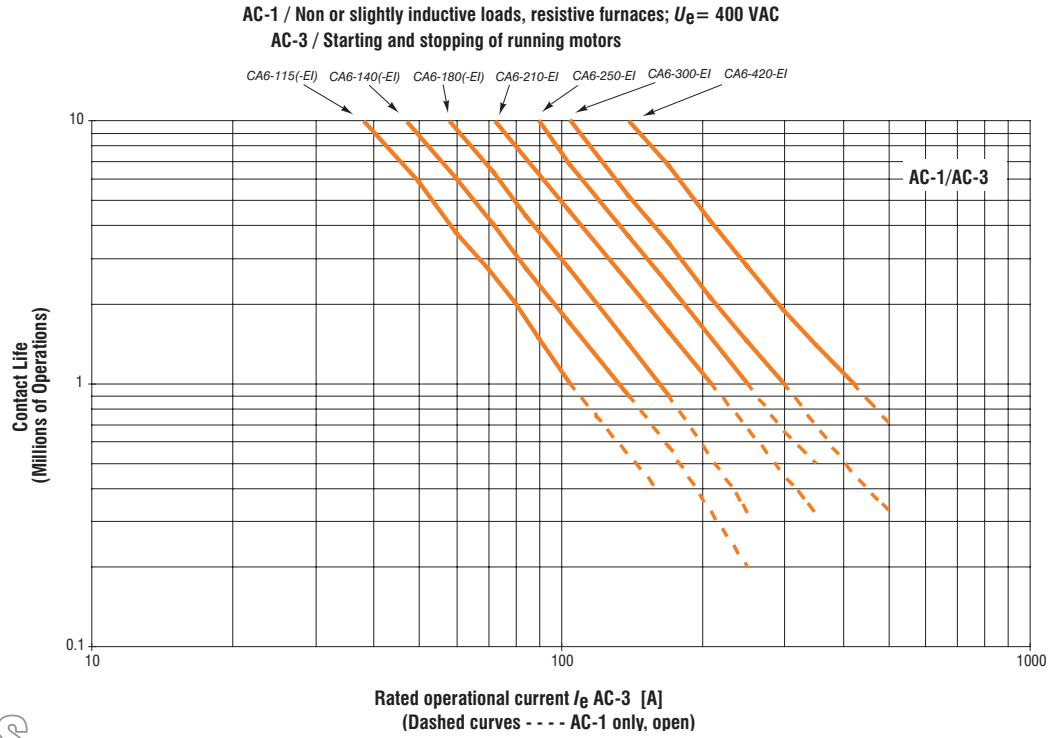

Instructions on
How to read
Life Curves
can be found on page A8

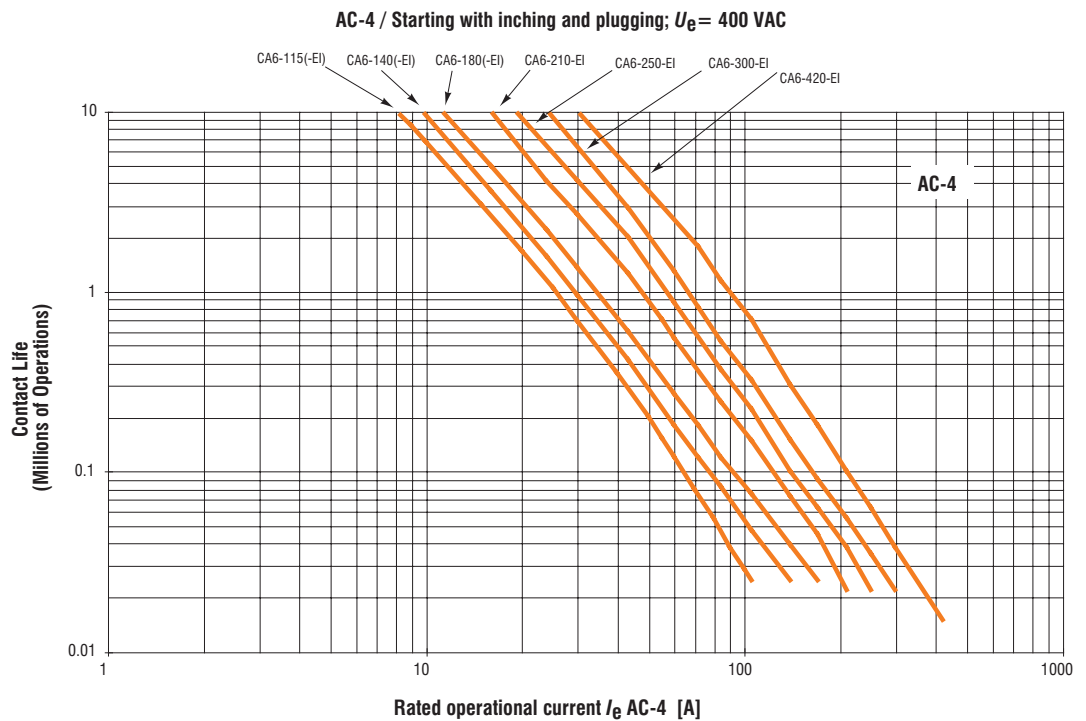

NOTE: The life-load curves shown here are based on Sprecher+Schuh tests according to the requirements defined in IEC 947-4-1. Since contact life in any given application is dependent on environmental conditions and duty cycle, actual application contact life may vary from that indicated by the curves shown here.

A
CA6 Contactors

Life-Load Curves

AC-3 (90%),
AC-4 (10%)

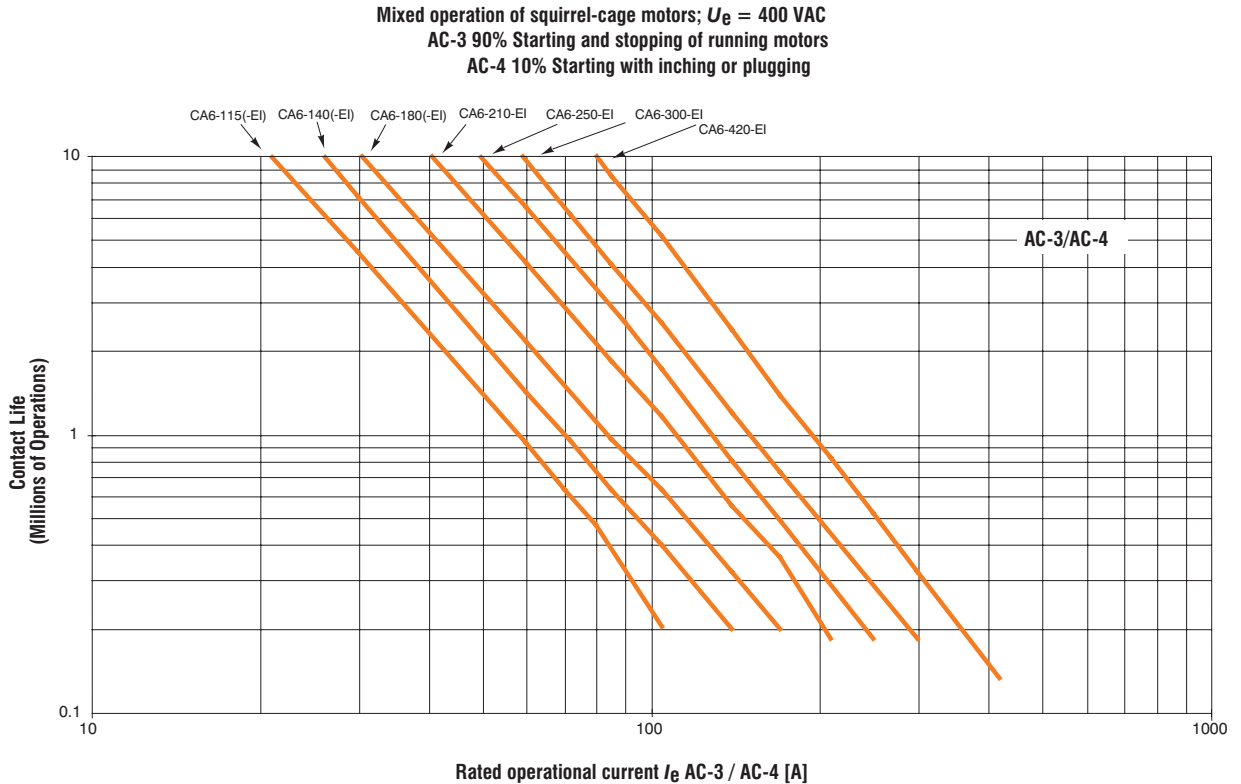

Contact Life for Mixed Utilization Categories AC-3 and AC-4

In many applications, the utilization category cannot be defined as either purely AC-3 or AC-4. In those applications, the electrical life of the contactor can be estimated with the following equation:

$$L_{\text{mixed}} = L_{\text{ac3}} / [1 + P_{\text{ac4}} \times (L_{\text{ac3}} / L_{\text{ac4}} - 1)], \text{ where:}$$

- L_{mixed} Approximate contact life in operations for a mixed AC-3/AC-4 utilization category application.
- L_{ac3} Approximate contact life in operations for a pure AC-3 utilization category (from the AC-3 life-load curve).
- L_{ac4} Approximate contact life in operations for a pure AC-4 utilization category (from the AC-4 life-load curve).
- P_{ac4} Percentage of AC-4 operations



NOTE: The life-load curves shown here are based on Sprecher+Schuh tests according to the requirements defined in IEC 947-4-1. Since contact life in any given application is dependent on environmental conditions and duty cycle, actual application contact life may vary from that indicated by the curves shown here.

Maximum Operating Rates

Squirrel cage motors; starting, switching off during running; $U_e = 400 \text{ VAC}$
250ms start time; 40% duty cycle

AC-3
250ms start time

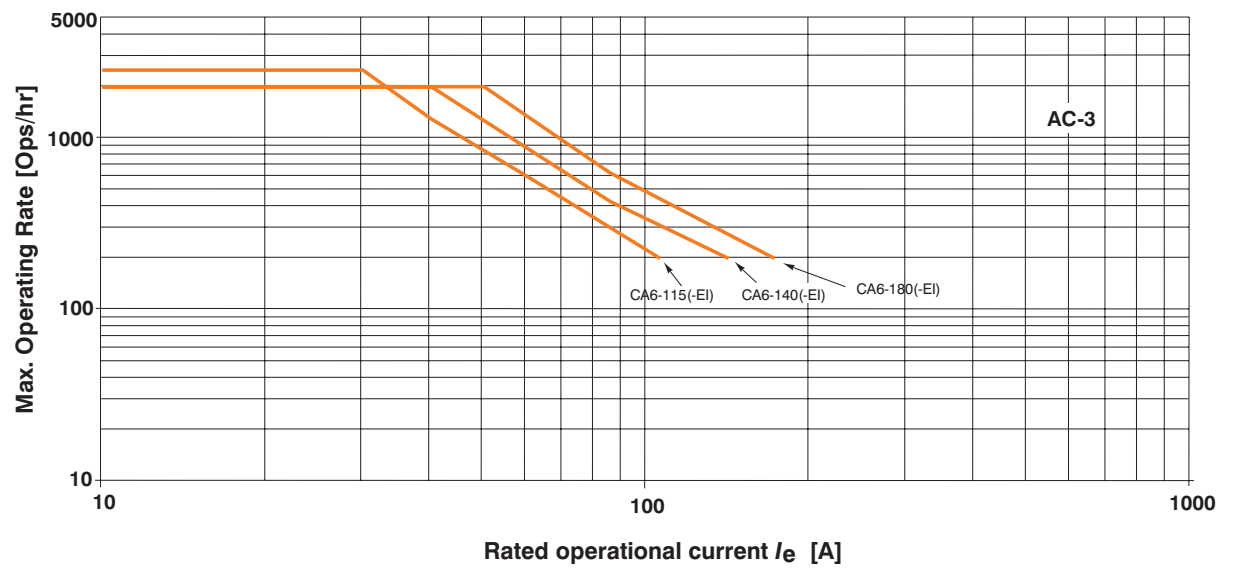

Squirrel cage motors; starting, switching off during running; $U_e = 400 \text{ VAC}$
1s start time; 40% duty cycle

AC-3
1 sec. start time

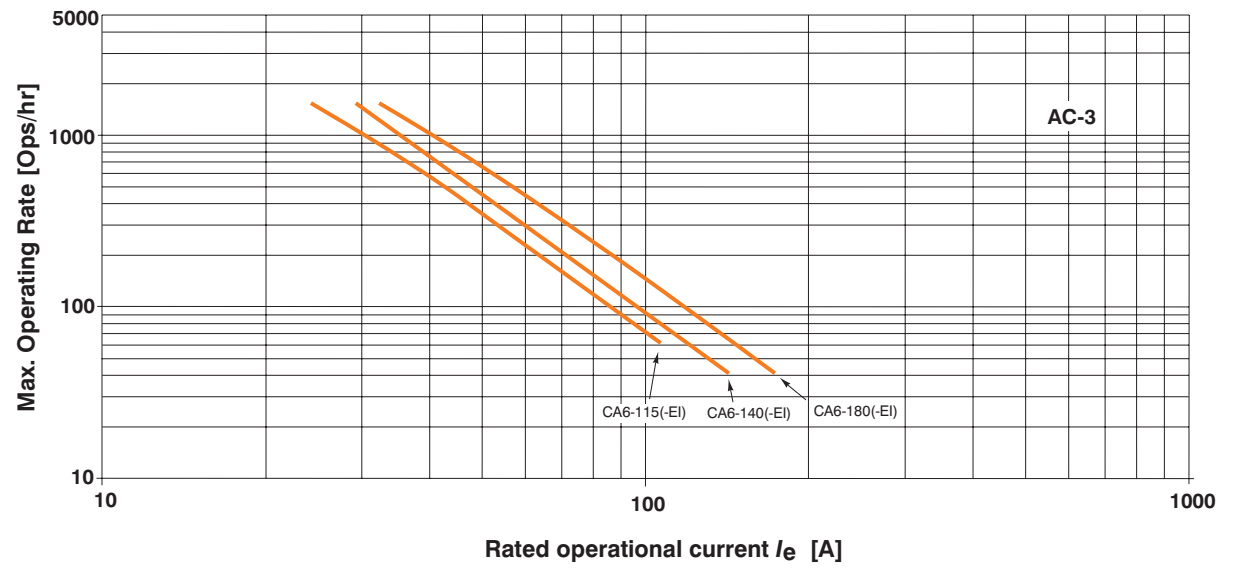

Series CA6 & Series CAU6 (Contactors & Reversing Contactors)

Dimensions are in millimeters (inches). Dimensions not intended for manufacturing purposes.

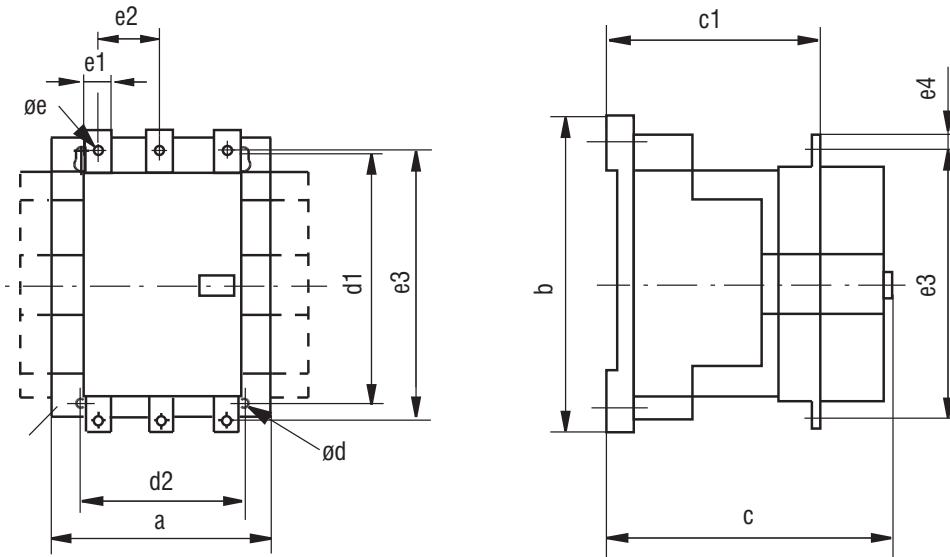

Catalog Number	a	b	c	c1	d	d1	d2	e	e1	e2	e3	e4
CA6-115(-EI); CA6-140(-EI); CA(N)6-180(-EI);	120 (4-3/4)	170 (6-11/16)	156 (6-1/8)	110.5 (4-11/32)	5.2 (7/32)	145 (5-11/16)	100 (3-15/16)	M8	20 (13/16)	39 (1-35/64)	160 (6-19/64)	10 (25/64)
CA6-210-EI...CA6-250-EI CA(N)6-300(-EI); CA6-420-EI	155 (6-1/8)	205 (8-1/16)	180 (7-3/32)	110.5 (4-11/32)	6.5 (9/32)	180 (7-3/32)	130 (5-1/8)	M10	25 (1)	48 (1-7/8)	193 (7-19/32)	12.5 (31/64)
CA6-630-EI...CA6-860-EI	255 (10-3/64)	310 (12-7/32)	265 (10-7/16)	110.5 (4-11/32)	10 (25/64)	230 (9-1/16)	225 (8-55/64)	M12	40 (1-37/64)	70 (2-3/4)	291 (11-29/64)	22 (55/64)

Reversing Contactors & Accessories (+...)

Contactor with...	CA6...	Dimension [mm]	Dimension [inches]
- auxiliary contact block ❶	+ S1	a	a
	+ S2	a + 13.5 mm each	a + 9/32 each
- reversing w/mechanical interlock		a + a	a + a
- main terminal set	HB2	b + 7mm each	b + 19/64 each
	HB3	b + 8.5mm each	b + 11/32 each
- label holder		c + 5mm	c + 3/16

Mounting Position

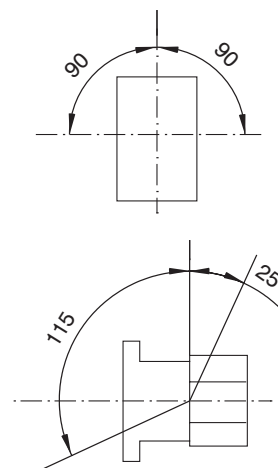

❶ No change of base dimensions with 1 or 2 auxiliary contact blocks (S1 or S2).
Each dimension increased by 13.5 mm to the "a" dimensions on the right hand side.

