

Series CA5 Contactors

CA5 Contactors

The contactor for heavy industrial applications from 500HP to 900HP

CA5 Series contactors provide large horsepower performance with a design that is up to 40% smaller than traditional contactors of this rating. The entire line is modularly designed for easy inspection, contact replacement and coil change out. All maintenance can be performed from the front so that mounting can be accomplished with no wasted space on the sides.

The contactor for large horsepower applications

The CA5 series consists of four contactors in two frame sizes covering motors from 500 to 900 HP (at 460V/575V). This line is well suited for heavy industrial applications utilizing large machinery and equipment such as rock quarries and mines, or for any large horsepower application where a rugged and dependable contactor is needed.



Specially designed shock-free contact system

A characteristic of contactors in this size class is to transmit intense impact forces during operation. This is caused by the heavy magnetic armatures of the core, which can cause contact "bounce." CA5 contactors, however, are designed so that the operating planes of the electromagnets and the contacts are opposed to each other by 90°. This results in a bounce-free contact system, increasing the contactor's mechanical life and raising contact reliability.

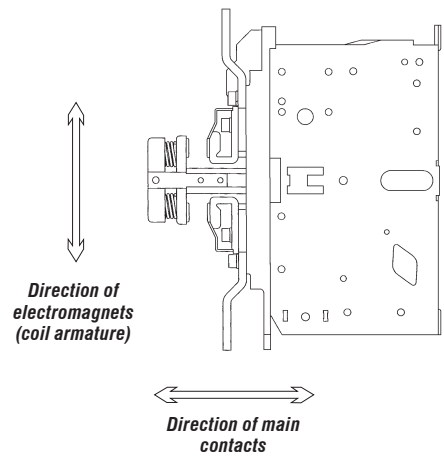

Rugged and reliable

A massive steel framework supporting the magnet system ensures high stability in all applications. Low-wear materials for bearings and sliding surfaces, as well as generously dimensioned magnet-pole faces result in above average mechanical life with a minimum of maintenance. Despite their rugged construction, overall contactor weight has been reduced considerably permitting simpler panel construction and easier assembly.

DISCONTINUED
This series is being replaced by the CA9 Series of contactors

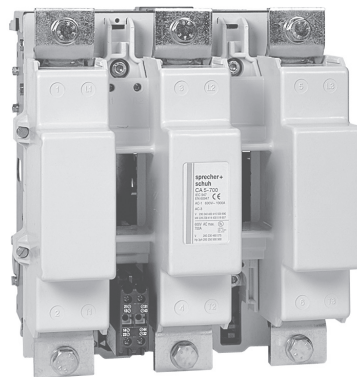

← 280mm (≈11") →
1000A
1100A

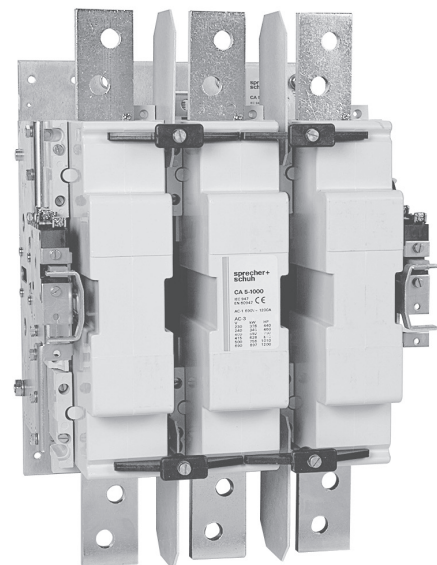

← 334mm (≈13 3/16") →
1200A
1350A

Unique coil “feeder group” offers many advantages

CA5-700 and 860 contactors are equipped with a special “feeder group” for the coil that accommodates AC control voltages of 50 or 60Hz, and a wide range of DC voltages.

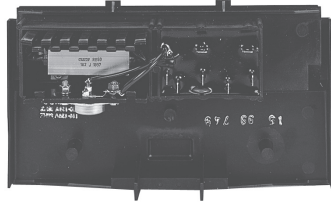

This coil arrangement eliminates noise and provides very low pickup and hold-in current. In addition, the dropout time of the coil can be adjusted within one of three ranges.

Normal Drop (150 to 200ms): for prompt reaction of contactor to a breaking command (factory setting).

Delayed Drop (0.5 to 1s): where it is necessary for the contactor to be immune to short power supply interruptions or uncertain control devices.

Fast Drop (about 20ms): for safety applications where instant dropout is required.

Adjustable auxiliary contacts

CA5 contactors can be equipped with a maximum of four NO and four NC auxiliary contacts. In addition, the closing time of the auxiliary contacts (on CA5-700 & 860 contactors) can be adjusted to meet individual control requirements.

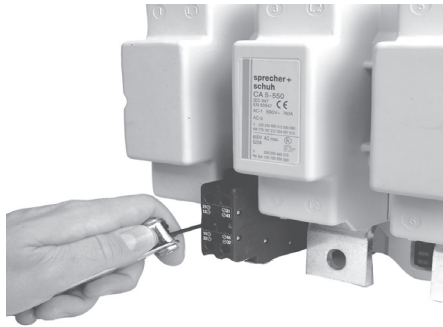

Add-on fourth pole

In many applications, the neutral also needs to be switched. All CA5 contactors can be fitted with a 4th pole on either the left or right side of the contactor. This switched neutral is available as an accessory that can easily be installed in the field.

Two choices for interlocking reversing contactors

Unique to the CA5 range is the ability to mechanically interlock reversing contactors in either a horizontal or vertical orientation. This feature allows maximum flexibility when laying out panels.

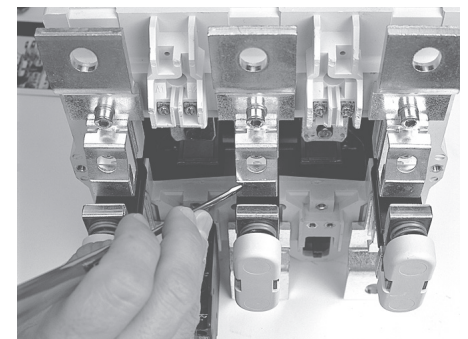
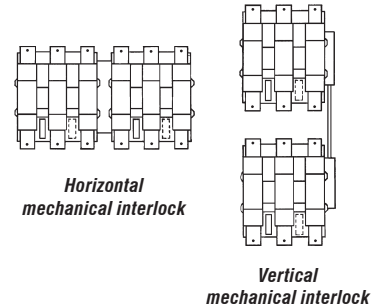

Simple main contact inspection and easy coil change

DISCONTINUED

Modular, convenient design

The CA5 line is modularly designed for easy inspection, coil change and contact replacement. Maintenance can be performed from the front so that mounting requires no additional space. Even with the installation of mechanical interlocks and auxiliary contact blocks, the units can be flush mounted side by side, saving panel space.

- 1 CA5-700 Contactor
- 2 CA5-1000 Contactor
- 3 Coil Pair
- 4 Feeder Group
- 5 4th Pole (Neutral Switching)
- 6 Auxiliary Contact Block
- 7 Auxiliary Contact Block
- 8 Mechanical Interlock (horizontal)
- 9 Mechanical Interlock (vertical)

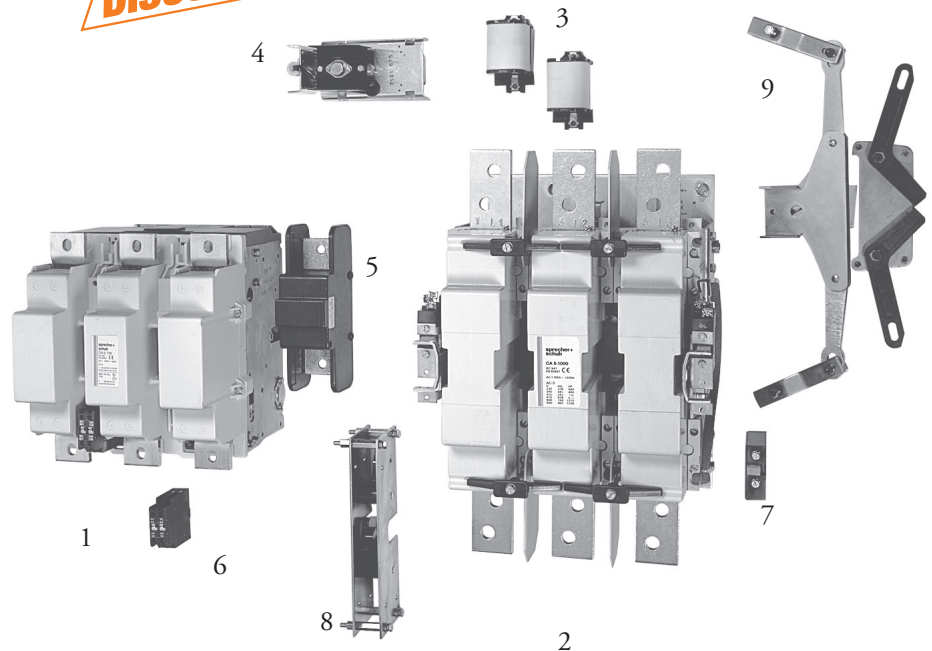

A full range of CA5 accessories is available, including a unique mechanical interlock that allows vertical mounting of contactors (see explanation above)

Non-Reversing, Three Pole Contactors With AC or DC Coil, Series CA5 (Open type only) ①③

I _e [A]		Ratings for Switching AC Motors (AC2 / AC3 / AC4)								Auxiliary Contacts per Contactor		Open Type	
		kW (50 Hz)				UL/CSA HP (60 Hz) ②							
		3 Ø											
AC-3	AC-1	230V	400V 415V	500V	690V	200V	230V	460V	575V	NO	NC	Catalog Number ①③	Price
700	1000	220	400	500	630	200	250	500	500	2	2	CA5-700-22-*	12232.42
860	1100	280	500	630	710	250	300	600	600	2	2	CA5-860-22-*	14950.74
1000	1200	315	560	750	850	~	~	~	~	1	2	CA5-1000-12-*	17459.95
1200	1350	375	710	850	1000	450	450	900	900	1	2	CA5-1200-12-*	21223.77

Note: CA5 open-type contactors include terminal bolts. See page A160 for Lugs.

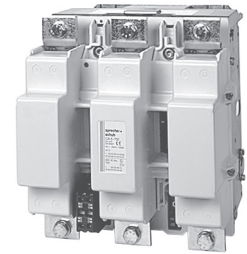

CA5-700-22 contactor

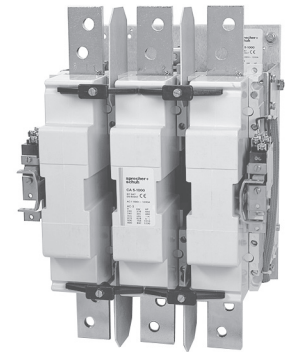

CA5-1000-12 contactor

Coil Codes ①②





CA5-700 / 860				CA5-1000 / 1200		
AC & DC Coil Code	Voltage Range			AC Coil Code	Voltage Range	
	50 Hz	60 Hz	VDC		50 Hz	60 Hz
120	110-120V	110-120V	100-110VDC	110	110V	110V
240	220-240V	220-240V	200-220VDC	220	220V	220V
380	380-415V	380-415V	345-380VDC	380	380V	380V
480	440-480V	440-480V	400-440VDC	440	440V	440V
				480	440-480V	440-480V

Ordering Instructions

Specify Catalog Number	
Replace (*) with Coil Code	See Coil Codes on this page

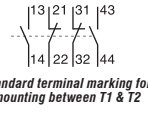
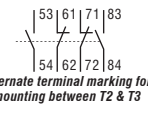
- ① CA5-700 and 860 contactors are equipped with coils that operate with both AC and DC control voltages. CA5-1000 and 1200 contactors operate with AC control voltage input that is rectified for DC coil operation. See page A161. Consult factory for DC control voltage input.
- ② Other voltages available, see page A161.
- ③ CA5-1000 horsepower ratings per IEC Utilization category AC-3. See CA5 Technical Data section for additional sizing information. Label does not bear a UL/CSA horsepower rating.

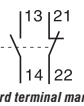
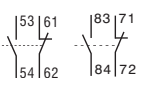
Auxiliary Contact Blocks (2 & 4 Pole)

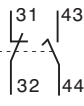
Contact Block	Description	NO	NC	Contact Arrangement	For use with...	Catalog Number	Price
 <p>4-pole</p>	<ul style="list-style-type: none"> For mounting between T1 & T2 or between T2 & T3 Adjustable; provides normal, delayed or overlapping contacts ❶ Maximum two blocks per contactor ❷ Alternate terminal marking tags included 	2	2	 <p>Standard terminal marking for mounting between T1 & T2</p>  <p>Alternate terminal marking for mounting between T2 & T3</p>	CA5-700 CA5-860	CA5-EF22 ❸	476.75
 <p>2-pole</p>	<ul style="list-style-type: none"> For side mounting on either side of the contactor Maximum four blocks per contactor ❹ Alternate terminal marking tags included 	1	1	 <p>Standard terminal marking</p> 	CA5-1000 CA5-1200	CA5-EB11 ❸	757.99
 <p>2-pole</p>	<ul style="list-style-type: none"> One supplied standard with contactor Special two pole design; 1 NO delayed make, 1 NC NO delayed make contact used for operation of the Feeder Group/Coil mechanism 	1 Delayed Make	1		CA5-1000 CA5-1200	CA5-EB11DC	835.36

Switched Neutral (4th Pole) ❹

4th Pole	4th Pole Amperes I _{th} AC-1	For use with...	Catalog Number	Price
	500	CA5-700 CA5-860	CA5-NP500/6	1181.42
	1000	CA5-700 CA5-860	CA5-NP1000/6	1547.35
		CA5-1000 CA5-1200	CA5-NP1000/7	2331.48

❶ Further information on adjustable contacts can be found under “Auxiliary Contacts” in the CA5 Technical Section.

❷ Contactor comes standard with one 4-pole aux contact block.

❸ In addition to one standard two-pole auxiliary contact block (CA5-EB11), CA5-1000 & 1200 contactors are equipped from the factory with a special two pole auxiliary contact block (CA5-EB11DC). One of the poles is used for operation of the Feeder Group/Coil mechanism, the other NC contact is available for use. Two additional aux contact blocks may be added for a total of four.

❹ No UL or cUL approval.

Main Lugs

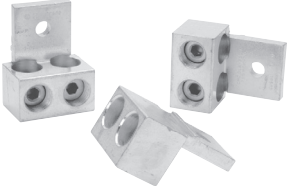
Lug or Accessory	Description	Wire Size	Catalog Number	Price
	Screw Type Lugs - (set of 6) For CA5-700 For CA5-860 For CA5-1000 & CA5-1200 ①	(2) 3/0- 750MCM (3) 2- 600MCM (4) 1/0- 750MCM	CA5-700-LU CA5-860-LU CA5-1200-LU	443.30 1151.10 1327.79

Mechanical Interlock Kit

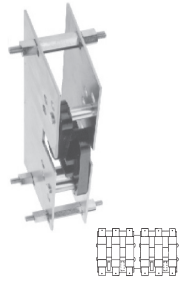
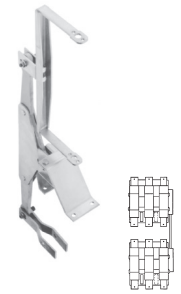
For Horizontal Mounting of Contactors			
Interlock	For use with...	Catalog Number	Price
	CA5-700 CA5-860 CA5-700/CA5-860	CA5-BM6H	791.44
	CA5-700/CA5-1000 CA5-700/CA5-1200 CA5-860/CA5-1000 CA5-860/CA5-1200	CA5-BM67H	2415.12
	CA5-1000 CA5-1200 CA5-1000/CA5-1200	CA5-BM7H	1495.07
For Vertical Mounting of Contactors			
	CA5-700 CA5-860 CA5-700/CA5-860	CA5-BM6V	791.44
	CA5-700/CA5-1000 CA5-700/CA5-1200 CA5-860/CA5-1000 CA5-860/CA5-1200	CA5-BM67V	2415.12
	CA5-1000 CA5-1200 CA5-1000/CA5-1200	CA5-BM7V	1495.07

Mechanical Latch

Latch	For use with...	Catalog Number	Price
	CA5-700 CA5-860	CA5-AM6-*	1442.80



CA5-AM6-*	
Replace * with Coil Code	
AC Coil Code	Voltage Range
120	110V - 120V
240	220V - 240V
415	380V - 415V
480	440V - 480V

① CA5-1000 is not UL Listed.

All CA5 contactor coils are made up of two parts; the Coil Pair and Feeder Group. When ordering replacement parts, usually assume the Coil Pair must be replaced. If control voltage changes, user must order Coil Pair and matching Feeder Group.

Even though all CA5 coils are designed for AC *input* (DC input also available for CA5-550...860 contactors), they are operated by a DC voltage *supplied* from a “feeder group”. Always order by

the Coil Code matched to the **actual control voltage available to the contactor**.

Further information on CA5 coil pairs and feeder groups can be found in CA5 Technical Information.

AC & DC Coil Pairs & Feeder Groups (CA5-550 to CA5-860) ①②

Voltage Range	COIL CODES	CA5-550		CA5-700 & CA5-860	
		Coil Pair	Feeder Group	Coil Pair	Feeder Group
110-120V 50/60Hz 100-110VDC	120	TX734 (22.807.301-10)	TXS734 (22.807.204-10)	TY734 (22.809.301-10)	TYS734 (22.809.204-10)
220-240V 50/60Hz 200-220VDC	240	TX747 (22.807.301-13)	TXS747 (22.807.204-13)	TY747 (22.809.301-13)	TYS747 (22.809.204-13)
380-415V 50/60Hz 345-380VDC	380	TX779 (22.807.301-16)	TXS779 (22.807.204-16)	TY779 (22.809.301-16)	TYS779 (22.809.204-16)
440-480V 50/60Hz 400-440VDC	480	TX780 (22.807.301-18)	TXS780 (22.807.204-18)	TY780 (22.809.301-18)	TYS780 (22.809.204-18)
Price		1000.55	972.32	1223.24	1160.51

AC Coil Pairs & Feeder Groups (CA5-1000 & CA5-1200) ①②

Voltage Range	AC COIL CODES	CA5-1000 & CA5-1200	
		Coil Pair	Feeder Group
110-115 Volts 50/60Hz	110	TZ734 (22.811.301-10)	TZS734 (22.811.204-10)
220-230 Volts 50/60Hz	220	TZ747 (22.811.301-13)	TZS747 (22.811.204-13)
380-400 Volts 50/60Hz	380	TZ779 (22.811.301-16)	TZS779 (22.811.204-16)
440 Volts 50/60Hz	440	TZ780 (22.811.301-18)	TZS780 (22.811.204-18)
440-480 Volts 50/60Hz	480	TZ781	TZS781
Price		1955.10	3376.98

DC Coil Pairs & Feeder Groups (CA5-1000 & CA5-1200) ②③

Voltage Range	DC COIL CODES	CA5-1000 & CA5-1200	
		Coil Pair	Feeder Group
110 Volts DC	110D	Refer to factory	Refer to factory
220 Volts DC	220D	Refer to factory	Refer to factory
440 Volts DC	480D	Refer to factory	Refer to factory
Price		Refer to factory	Refer to factory

- ① Other voltages available. Please contact factory.
- ② CA5-550, 700 and 860 contactors are equipped with coils that operate with both AC and DC control voltages. For DC coil operation, select AC Coil Code for desired DC voltage. CA5-1000 and 1200 contactors operate with AC control voltage input that is rectified for DC coil operation. See page A167. Consult factory for DC control voltage input.



CA5 Coil Pair (typical)

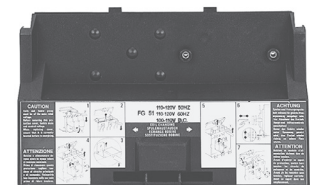

CA5 Feeder Group - front view (typical)

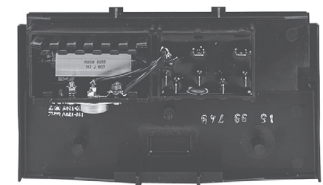



CA5 Feeder Group - rear view (typical)

Main Contact - (1 Pole Per Set)

Main Contacts (1pole) <i>(typical)</i>	For use with...	Catalog Number	Price per pole
	CA5-550	CA5-CP550 (22.807.202-01)	318.88
	CA5-700	CA5-CP700 (22.808.202-01)	479.89
	CA5-860	CA5-CP860 (22.809.202-01)	635.67
	CA5-1000	CA5-CP1000 (22.810.202-01)	801.90
	CA5-1200	CA5-CP1200 (22.811.202-01)	959.78

Arc Chutes

Arc Chutes <i>(typical)</i>	For use with...	Catalog Number	Price
 <p>3-pole (1 per contactor)</p>	CA5-550	CA5-AC550 (22.807.201-01)	930.50
	CA5-700/ CA5-860	CA5-AC860 (22.809.201-01)	1505.53
 <p>1-pole (3 per contactor)</p>	CA5-1000/ CA5-1200	CA5-AC1200 (22.811.201-01)	1029.82

Technical Information

			CA5-550	CA5-700 ❶	CA5-860	CA5-1000	CA5-1200	
Rated Insulation Voltage U_i								
to IEC947-1	[V]		690	690	690	690	690	
UL/CSA	[V]		600	600	600	600	600	
Rated Impulse Voltage U_{imp}								
CA5-550 / 700 / 860	[kV]		8	8	8	8	8	
CA5-1000 / 1200	[kV]		2.5	2.5	2.5	2.5	2.5	
Rated Voltage U_e-Main Contacts								
AC 50/60Hz	[V]		220/230, 240, 380/400, 415, 500, 660/690 (1000V - CA5-550 to 860)					
DC	[V]		24, 48, 110, 220, 440V					
Operating Frequency for AC Loads			[Hz]	50/60Hz	180/hr. for 0.25s start time - 42/hr. for 1s start time			
Switching Motor Loads								
Standard IEC Ratings								
AC-2, AC-3								
DOL & Reversing								
50Hz/60° C								
		230/240V	[A]	550	700	860	1000	1200
		400/415V	[A]	550	700	860	1000	1200
		500V	[A]	550	700	860	1000	1200
		690V	[A]	500	630	700	860	1000
		230V	[kW]	179	228	280	326	391
		240V	[kW]	187	238	293	340	408
		400V	[kW]	312	414	509	592	710
		415V	[kW]	324	430	528	628	737
		500V	[kW]	407	518	636	756	888
		690V	[kW]	510	657	730	897	1043
UL/CSA								
DOL & Reversing		200V	[A]	414	552	692	~	1185
60Hz		230V	[A]	360	602	722	~	1130
		460 V	[A]	414	590	708	~	1062
	3∅	575 V	[A]	336	472	576	~	864
		200 V	[HP]	150	200	250	~	450
		230 V	[HP]	150	250	300	~	450
		460 V	[HP]	350	500	600	~	900
		575 V	[HP]	350	500	600	~	900
AC4 -200,000 Op. Cycles								
50Hz		230/240V	[A]	140	180	210	260	300
		400/415V	[A]	140	180	210	260	300
		230V	[kW]	45	57	67	83	97
		240V	[kW]	47	60	70	87	101
		400V	[kW]	78	101	118	146	170
		415V	[kW]	81	105	122	151	176
AC4 -200,000 Op. Cycles (25,000)								
Squirrel-cage motors with reversing and jogging		230/240V	[A]	360	430	520	(630)	(700)
		400/415V ❶	[A]	350	420	520	(630)	(700)
		230V	[kW]	116	139	170	(205)	(228)
		240V	[kW]	120	151	177	(214)	(245)
		400V	[kW]	198	238	295	(357)	(414)
		415V	[kW]	206	247	300	(359)	(424)

❶ At rated voltage (415V) and rated current: Life span –25%.

A

CA5 Contactors

Electrical Data

			CA5-550	CA5-700	CA5-860	CA5-1000	CA5-1200	
Switching Motor Loads (continued)								
Wye-Delta (Star Delta)	50 Hz	230V	[A]	953	1212	1490	1732	2078
		240V	[A]	953	1212	1490	1732	2078
		400V	[A]	953	1212	1490	1732	2078
		415V	[A]	953	1212	1490	1732	2078
		500V	[A]	953	1212	1490	1732	2078
		690V	[A]	831	1091	1195	1490	1732
	60 Hz	230V	[kW]	310	395	485	565	677
		240V	[kW]	324	412	507	589	707
		400V	[kW]	540	717	882	1025	1250
		415V	[kW]	561	745	915	1088	1278
		500V	[kW]	705	897	1102	1309	1538
		690V	[kW]	883	1138	1247	1554	2078
AC-1 Load, 3Ø Switching	Ambient Temperature 40° C	I_{th}	[A]	760	1000	1100	1200	1350
		230V	[kW]	303	398	438	478	538
		240V	[kW]	316	416	457	499	561
		400V	[kW]	527	693	762	831	935
		415V	[kW]	546	719	791	863	970
		500V	[kW]	658	866	953	1039	1169
	Ambient Temperature 60° C	I_{th}	[A]	605	800	870	960	1085
		230V	[kW]	241	319	347	382	432
		240V	[kW]	251	333	362	399	451
		400V	[kW]	419	554	603	665	752
		415V	[kW]	435	575	625	690	780
		500V	[kW]	524	693	753	831	940
Continuous Current (UL/CSA)	General Purpose Rating (40° C)		[A]	520	700	810	~	1215
Rated Making Capacity	415V	[A]	5500	7000	8600	10000	12000	
	500V	[A]	5500	7000	8600	10000	12000	
	690V	[A]	5500	7000	8600	10000	12000	
Rated Breaking Capacity	AC-3 I_b	240V	[A]	4400	5600	6900	8000	9600
		400V	[A]	4400	5600	6900	8000	9600
		415V	[A]	4400	5600	6900	8000	9600
		500V	[A]	4400	5600	6900	8000	9600
		690V	[A]	4000	5100	5600	6900	8000
Short Circuit Protection of Contactors								
Without Overload Relay								
Fuse gG (aM) Type 1 Coordination (per IEC 60947-4-1)	500V	[A]	(630)	800	1000	1000	1250	
	690V	[A]	(630)	800	1000	1000	1000	

Electrical Data

				CA5-550	CA5-700	CA5-860	CA5-1000	CA5-1200
DC Ratings								
DC-1 Rating at 60° C								
Non-inductive or slightly inductive loads, resistive furnaces	1 pole	24VDC	[A]	645	760	930	1020	1150
		48VDC	[A]	645	760	930	1020	1150
	2 Poles in Series	24VDC	[A]	645	760	930	1020	1150
		48VDC	[A]	645	760	930	1020	1150
		110VDC	[A]	480	560	630	800	900
		220VDC	[A]	315	400	450	500	600
	3 Poles in Series	24VDC	[A]	605	800	870	960	1085
		48VDC	[A]	605	800	870	960	1085
		110VDC	[A]	480	560	630	800	900
		220VDC	[A]	315	400	450	500	600
DC-3 Rating at 60° C								
Shunt wound motors - Starting, reverse current breaking, reversing, stepping	3 Poles in Series	24VDC	[A]	605	800	870	960	1085
		48VDC	[A]	605	800	870	960	1085
DC-5 Rating at 60° C								
Series wound motors - Starting, reverse current breaking, reversing, stepping	3 Poles in Series	24VDC	[A]	605	800	870	900	1085
		48VDC	[A]	605	800	870	900	1085
Lighting Loads								
Elec. Dischrg. Lamps-AC-5a, single compensated	Open	[A]		450	570	700	850	1000
		En-closed	[A]	360	460	550	660	800
Incandescent Lamps - AC AC-5b, Electrical endurance ~100,000 operations		[A]		315	440	500	560	630
Switching power transformers AC-6a								
Inrush = nxI_e								
Rated transformer current								
n = 30	Inrush	400 VAC	[A]	7,440	9,450	11,700	13,500	16,200
		400 VAC	[A]	248	315	390	450	540
		400 VAC	[kVA]	172	218	270	312	374
		500 VAC	[kVA]	215	273	338	390	468
		690 VAC	[kVA]	269	339	376	538	645
n = 20		400 VAC	[A]	371	472	580	675	810
n = 15		400 VAC	[A]	435	630	774	900	1080
Rated making Capacity								
AC-3 I _e		≤415V	[A]	5,500	7,000	8,600	10,000	12,000
		500V	[A]	5,500	7,000	8,600	10,000	12,000
		690V	[A]	5,500	7,000	8,600	10,000	12,000
Rated making Capacity								
AC-3 I _e		≤240V	[A]	4,400	5,600	6,900	8,000	9,600
		400V	[A]	4,400	5,600	6,900	8,000	9,600
		415V	[A]	4,400	5,600	6,900	8,000	9,600
		500V	[A]	4,400	5,600	6,900	8,000	9,600
		690V	[A]	4,000	5,100	5,600	6,900	8,000

Electrical Data

			CA5-550	CA5-700	CA5-860	CA5-1000	CA5-1200
Capacitor Ratings							
Capacitor Switching - 50Hz							
Single Capacitor - 40°C	230 V	[kVar]	180	220	250	290	330
	240 V	[kVar]	200	250	300	325	360
	400 V	[kVar]	320	400	450	500	575
	415 V	[kVar]	350	430	500	550	630
	500 V	[kVar]	450	520	600	660	750
	690 V	[kVar]	580	700	800	875	1000
	Single Capacitor - 55°C	230 V	[kVar]	150	180	220	275
240 V		[kVar]	170	200	260	300	350
400 V		[kVar]	280	330	400	460	550
415 V		[kVar]	300	360	450	500	600
500 V		[kVar]	360	420	540	600	720
690 V		[kVar]	500	580	720	800	950
Capacitor Bank - 40°C		230 V	[kVar]	180	220	250	290
	240 V	[kVar]	200	250	300	325	360
	400 V	[kVar]	320	400	450	500	575
	415 V	[kVar]	350	430	500	550	630
	500 V	[kVar]	450	520	600	660	750
	690 V	[kVar]	580	700	800	875	1000
	Capacitor Bank - 55°C	230 V	[kVar]	150	180	220	275
240 V		[kVar]	170	200	260	300	350
400 V		[kVar]	280	330	400	460	550
415 V		[kVar]	300	360	450	500	600
500 V		[kVar]	360	420	540	600	720
690 V		[kVar]	500	580	720	800	950
Short-Circuit Coordination							
Short Time Current Withstand Ratings							
I_{cw} 60°C	1 s	[A]	5500	7000	8000	10000	12000
	4 s	[A]	5500	7000	8000	10000	12000
	10 s	[A]	4400	5600	6900	8000	9600
	15 s	[A]	3800	5000	6000	7400	8500
	60 s	[A]	2300	2800	3400	4000	4800
	240 s	[A]	1300	1800	2000	2300	2700
	900 s	[A]	850	1150	1350	1600	1900
Off Time Between Operations	[Min.]	60	60	60	60	60	
Resistance and Watt Loss I_e AC3							
Resistance per power pole	[mΩ]	0.11	0.1	0.08	0.06	0.05	
Watt Loss - 3 power poles	[W]	99	147	177	180	216	
Coil and 3 power poles (including series resistor)	AC	[W]	110	172	202	250	286
	DC	[W]	109	169	199	240	276

Electrical Data

			CA5-550	CA5-700	CA5-860	CA5-1000	CA5-1200
Coil Data							
Voltage Range							
AC: 50Hz, 60Hz, 50/60 Hz	Pickup	[xU_s]	0.85...1.1	0.85...1.1	0.85...1.1	0.85...1.1	0.85...1.1
	Dropout	[xU_s]	0.2...0.5	0.20...0.75	0.20...0.75	0.1...0.6	0.1...0.6
DC	Pickup	[xU_s]	0.85...1.1	0.85...1.1	0.85...1.1	0.85...1.1	0.85...1.1
	Dropout	[xU_s]	0.2...0.5	0.20...0.75	0.20...0.75	0.1...0.6	0.1...0.6
Coil Consumption							
AC: 50Hz, 60Hz, 50/60 Hz	Pickup	[VA]	800...950	1350...1600	1350...1600	2400	2400
	Hold-in	[VA]	9...11	21...25	21...25	70	70
DC	Pickup	[VA]	700...850	1350...1600	1350...1600	2400	2400
	Hold-in	[W]	8...10	21...25	21...25	70	70
Operating Times							
AC: 50Hz, 60Hz, 50/60 Hz	Pickup	[ms]	50...100	50...100	50...100	50...100	50...100
	Normal Dropout	[ms]	150...200	150...200	150...200	25...50	25...50
	Delayed Dropout	[ms]	500...1000	500...1000	500...1000	~	~
	Accelerated Dropout	[ms]	20...50	20...50	20...50	~	~
DC	Pickup	[ms]	50...100	50...100	50...100	50...100	50...100
	Normal Dropout	[ms]	150...200	150...200	150...200	25...50	25...50
	Delayed Dropout	[ms]	500...1000	500...1000	500...1000	~	~
	Accelerated Dropout	[ms]	20...50	20...50	20...50	~	~

Insulation Class Class "B" to VDE 0660 table 22

Control and Magnet System for CA5-700...CA5-860 Contactors

Even though the **input** to the magnet system can either be AC or DC, the low pull-in and holding consumption of the magnet system is achieved by DC operating coils **supplied** by a "Feeder Group". The Feeder Group for these contactors also allows delayed, normal or accelerated dropout times, selectable between 20ms and 1000ms.

- Delayed: (500...1000ms)
- Normal: (150...200ms)
- Accelerated: (20...50ms)

As supplied, the contactors are wired for a normal dropout time. To compensate for wide voltage fluctuations or brief supply voltage interruptions, the dropout time can be delayed by wiring changes made to the Feeder Group at installation.

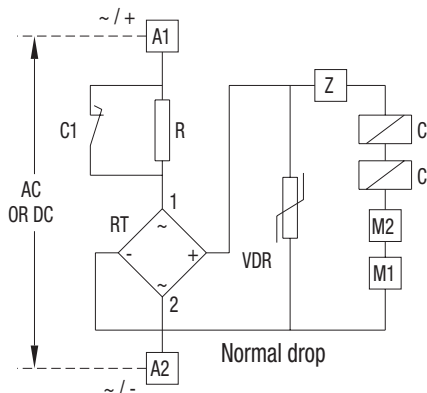

Coil Circuit for CA5-550, 700 & 860
AC or DC supply

Control and Magnet System for CA5-1000...CA5-1200 Contactors

Even though the **input** to the magnet system is only designed for AC voltages, the low pull-in and holding consumption of the magnet system is achieved by DC operating coils **supplied** by a "Feeder Group". The Feeder Group for these contactors is configured for a dropout time of 25...50ms. Dropout times for these contactors are not selectable.



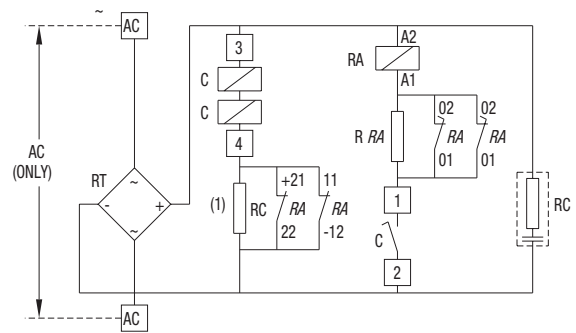

Further information regarding circuit possibilities can be obtained from assembly instructions supplied with each device.



Coil Circuit for CA5-1000 & 1200
AC supply (only)

- C:** Coil pair
- RA:** DC auxiliary relay coil for economy resistor switching
- R, RC, RRA:** Economy resistor
- VDR:** Varistor
- M1, M2:** Terminals for fast-drop connection
- Z:** Device for dropout operating time variation
- (1)** For control voltages up to 125V NC contacts 11-12 & 21-22 are connected in parallel; higher voltages are connected in series



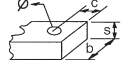
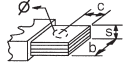
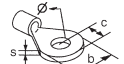

Mechanical Data

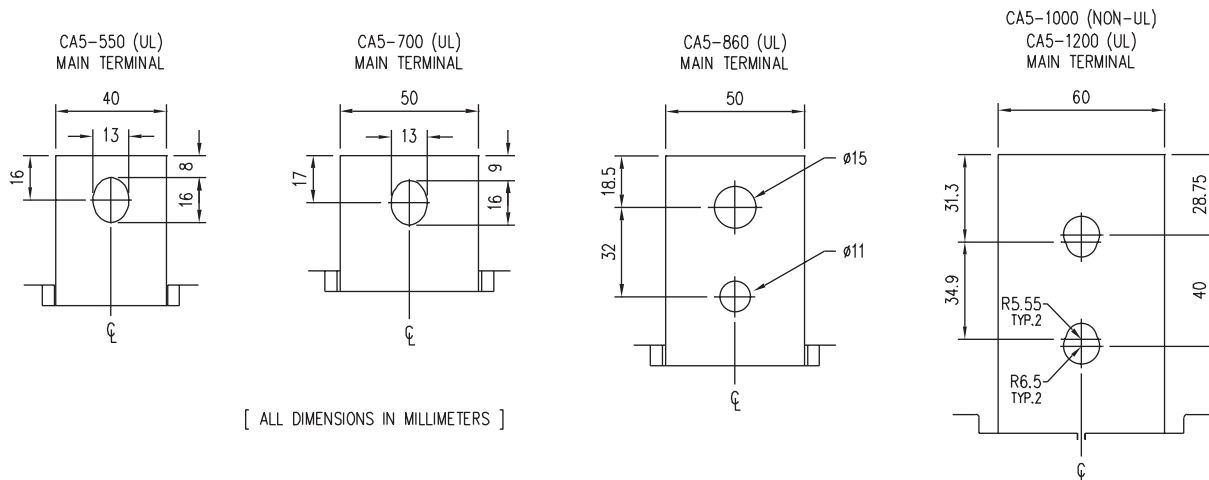
			CA5-550	CA5-700	CA5-860	CA5-1000	CA5-1200
Service Life							
Mechanical	AC Control	[Mil.]	5	5	5	1	1
	DC Control	[Mil.]	5	5	5	1	1
Electrical	AC-3 (400V)	[Mil.]	0.6	0.6	0.6	0.6	0.6
Shipping Weights							
AC - CA5	AC Control	[kg]	13.8	26.4	28.4	50.3	53.4
	DC Control	[Lbs]	30.4	58.1	62.5	110.8	117.6
AC - CAU5	AC Control	[kg]	28.5	53.9	57.9	102.3	108.5
	DC Control	[Lbs]	63.6	120.3	129.2	228.3	242.2
Terminations - Power							
Type							
				Hexagonal Bolt			
Direct Connection (customer supplied connections)							
	b max.	[mm]	50	60	60	60	60
	c max.	[mm]	20	20	25	25	25
	s max.	[mm]	2 x 5	2 x 5	2 x 6	2 x 6	2 x 8
	Ø min.	[mm]	Refer to CA5 stab dimensions below				
Recommended Torque		[Nm]	50	60	75	60	60
		[Lb-ft]	37	44	55	44	44

CA5 Stab Dimensions







Mechanical Data (continued)

	CA5-550	CA5-700	CA5-860	CA5-1000	CA5-1200
Terminations - Control					
Description	Combination Screw Head: Cross, Slotted, Pozidrive				
Coils	1 or 2	[mm2]	4		
Wires		[AWG]	25		
Control Modules	1 or 2	[mm2]	4		
Wires		[AWG]	25		
Torque Requirement		[Nm]	1..2.5		
		[Lb-in]	8.9...22		
Degree of Protection - contactor	IP00 (open) per IEC 60529 and DIN 40 050				
Environmental and General Specifications					
Rated Isolation Voltage U_i					
IEC, AS, BS, SEV, VDE 0660	[V]	1000V		690V	
UL/CSA	[V]	600V		600V	
Impulse Voltage - U_{imp}					
1 minute per IEC 60947-1	[kV]	8kV		2.5kV	
Ambient Temperature					
Storage	-40...+80° C (-13...176° F)				
Operation at rated current	-25...+70° C (-13...158° F) (40° C per UL)				
Altitude at installed site	2000 meters above sea level per IEC 60947-1				
Operating Frequency for AC Loads					
50/60 Hz	180/Hr. for 0.25, start time 42/ HR for 1s start time				
Resistance to Corrosion / Humidity	Damp-alternating climate: cyclic per DIN 50 016 and 40 046 Part 38 IEC 60068				
	Dry heat: IEC 68-2, + 100° C (212° F), relative humidity ,50%, 7 days				
	Damp tropical: IEC 68-2, +40° C (104° F), relative humidity 95%, 56 days ❶				
Operating Position	See dimensions page				
Standards	IEC/EN 60947, ul508, csa C22.2 No. 14				
Approvals	cULus, CE				

❶ Per DIN 50 016 and 40 046, part 38.

Auxiliary Contacts

		Auxiliary Contact Block								Auxiliary Contact Blocks								
Switching, AC & DC Loads		CA5-EF22								CA5-EB11, CA5-EB11DC								
AC- I_m	at 40°C	[A]	16								16							
	at 60°C	[A]	12								12							
AC-15, switching electromagnetic loads at:		[V]	120	230	240	400	415	500	690	120	230	240	400	415	500	690		
		[A]	6	3	3	2	2	1.5	1	6	3	3	2	2	1.5	1		
DC-13, switching DC electromagnets at:		[V]	24 48 110 220								24 48 110 220							
		[A]	6 3 1 0.5								6 3 1 0.5							
Minimum Switching Capacity			10V, 5MA								-							
Short-Circuit Protection - gGFuse																		
Type 2 Coordination		[A]	10								16							
Terminals																		
Terminal Type																		
Maximum Wire Size per IEC 947-1			2 x A4								2 x A4							
	Flexible with Wire-End Fernule	1 Conductor [mm²]	1...4								0.5...2.5							
		2 Conductor [mm²]	1...4								0.75...2.5							
	Solid/Stranded-Conductor	1 Conductor [mm²]	1.5...6								0.5...2.5							
		2 Conductor [mm²]	1.5...6								0.75...2.5							
Recommended Tightening Torque		[Nm]	1...2.5								1...1.5							
Max. Wire Size per UL/CSA		[AWG]	16...10								18...14							
Recommended Tightening Torque		[lb-in]	8.9...22								8.9...13.3							
Degree of Protection			IP2LX per IEC 529 and DIN 40 050															

Mechanical Latch

		CA5-AM5		CA5-AM6		CA5-AM7		
Service Life								
Mechanical		[Mil ops.]	0.5		0.5		0.5	
Dropout Delay								
Contactor Latch		[ms]	50...70		50...70		50...70	
Trip Coil								
Consumption	AC	[VA]	950		1600		3500	
	DC	[W]	500		800		3200	
OFF-command (min. impulse duration)		[ms]	200		200		200	
Operation Voltage								
Minimum			0.5 U_n		0.5 U_n		0.5 U_n	
Maximum			1.1 U_n		1.1 U_n		1.1 U_n	

Auxiliary Contacts

For CA5-700 & CA5-860 contactors

Up to two auxiliary contact blocks can be mounted on each contactor. One four-pole auxiliary contact block (CA5-EF22) is supplied standard and is installed on the contactor between T1 and T2. One additional auxiliary contact block can be installed between T2 and T3.

Each CA5-EF22 contains 2 NO and 2 NC adjustable auxiliary contacts. Standard terminal markings are shown below on the left. If an additional contact block is required, different terminal markings (right) are supplied and may be applied by the user.

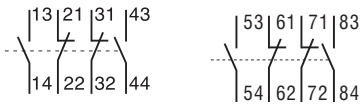

Adjustable Auxiliary Contacts

The instant at which the NO contact closes, in relation to the main contacts, can be adjusted from the front of the CA5-EF22 auxiliary contact block by means of an Allen wrench. The following diagrams show the adjustments for Normal, Delayed and Overlapping auxiliary contacts.

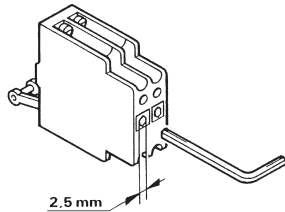

Normal Setting (from factory)

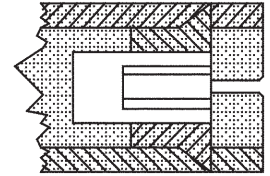
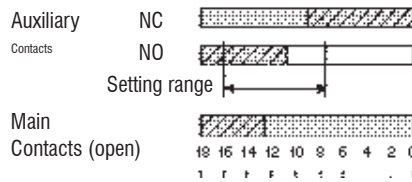

Delayed NO Contact

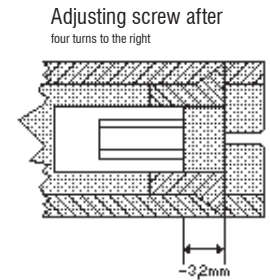
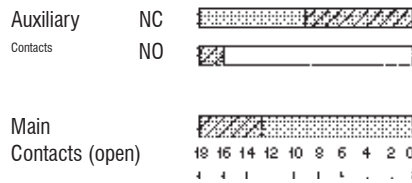

Overlapping NO and NC Contacts

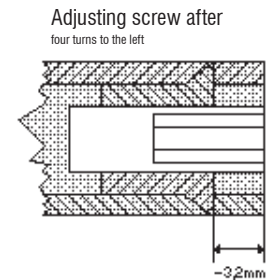
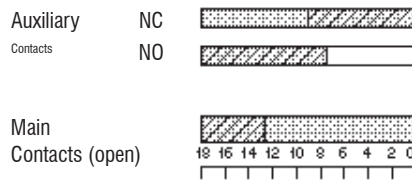

For CA5-1000 and CA5-1200 contactors

Up to four nonadjustable auxiliary contact blocks can be mounted on each contactor. One CA5-EB11 two pole aux contact and one CA5-EB11DC two pole aux contact come standard. The CA5-EB11DC has 1 NC contact (available) and 1 NO Delayed Make (unavailable) which is used for the operation of the coil feeder group.

- CA5-EB11 – 1 NO/1NC
- CA5-EB11DC – 1 NO Delayed Make/1 NC

A
CA5 Contactors

Life-Load Curves

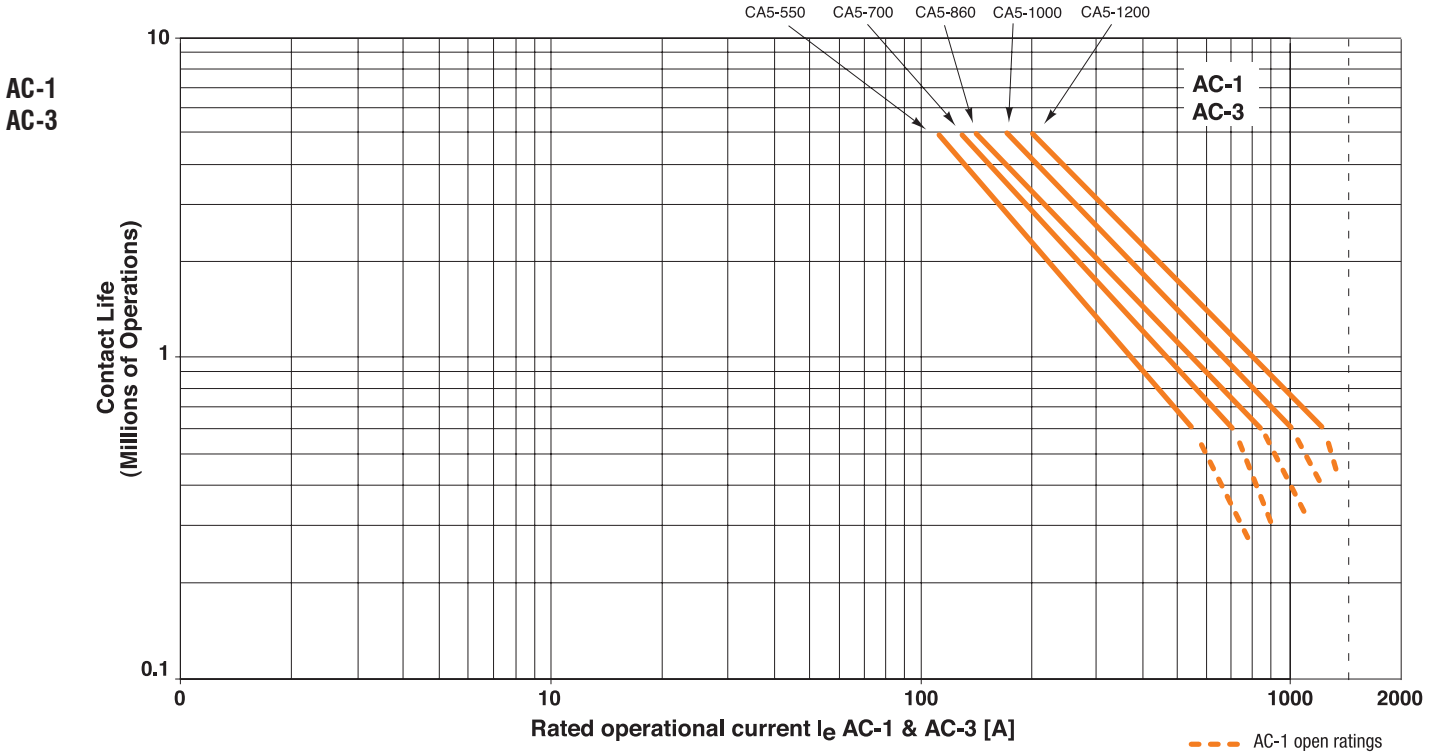

AC-1 - Non or slightly inductive loads, resistive furnaces; $U_e=380...460$ VAC
 AC-3 - Switching squirrel-cage induction motors during starting; $U_e=380...460$ VAC

Instructions on
How to read
 Life Curves
 can be found on page A8

NOTE: The life-load curves shown here are based on Sprecher+Schuh tests according to the requirements defined in IEC 947-4-1. Since contact life in any given application is dependent on environmental conditions and duty cycle, actual application contact life may vary from that indicated by the curves shown here.

Life-Load Curves

A
CA5 Contactors

AC-4

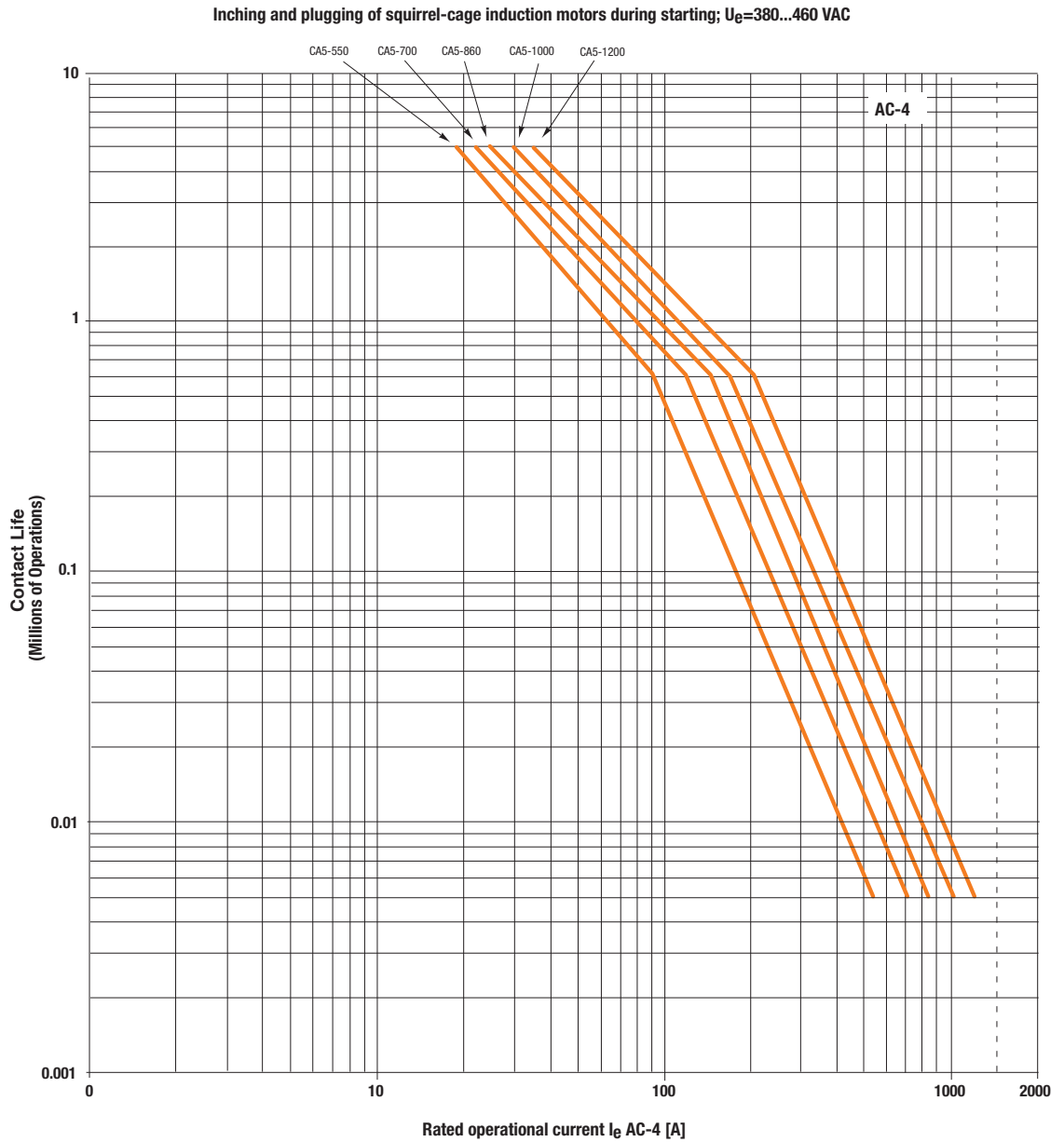

NOTE: The life-load curves shown here are based on Sprecher+Schuh tests according to the requirements defined in IEC 947-4-1. Since contact life in any given application is dependent on environmental conditions and duty cycle, actual application contact life may vary from that indicated by the curves shown here.

A

Life-Load Curves

CA5 Contactors

AC-3 (90%),
AC-4 (10%)

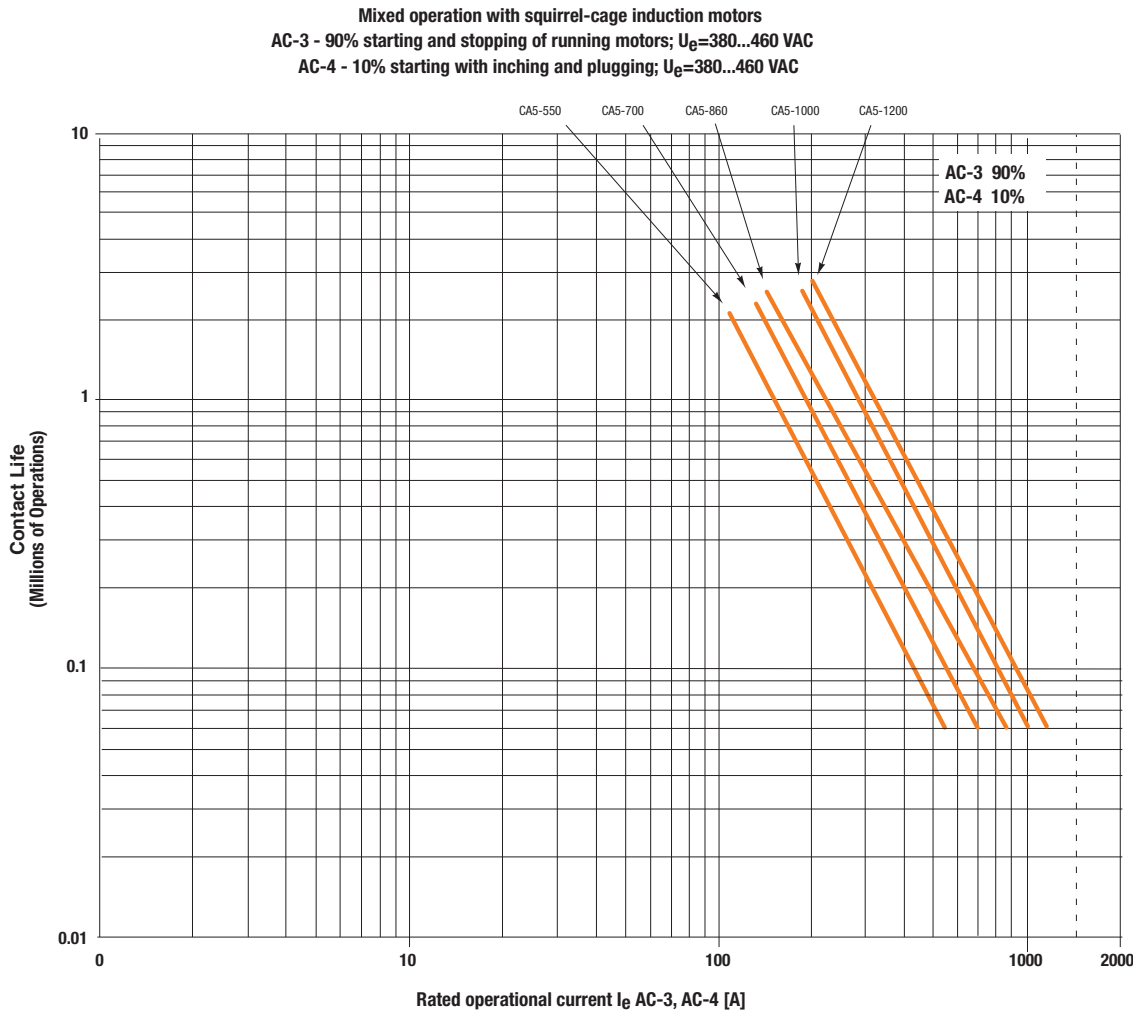

Contact Life for Mixed Utilization Categories AC-3 and AC-4

In many applications, the utilization category cannot be defined as either purely AC-3 or AC-4. In those applications, the electrical life of the contactor can be estimated with the following equation:

$$L_{mixed} = L_{ac3} / [1 + P_{ac4} \times (L_{ac3} / L_{ac4} - 1)], \text{ where:}$$

- L_{mixed} Approximate contact life in operations for a mixed AC-3/AC-4 utilization category application.
- L_{ac3} Approximate contact life in operations for a pure AC-3 utilization category (from the AC-3 life-load curve).
- L_{ac4} Approximate contact life in operations for a pure AC-4 utilization category (from the AC-4 life-load curve).
- P_{ac4} Percentage of AC-4 operations

NOTE: The life-load curves shown here are based on Sprecher+Schuh tests according to the requirements defined in IEC 947-4-1. Since contact life in any given application is dependent on environmental conditions and duty cycle, actual application contact life may vary from that indicated by the curves shown here.

Operating Rate Curves

AC-3

Starting and stopping of running motors
Starting time $t_A = 0.25$ s
Relative time energized 40%

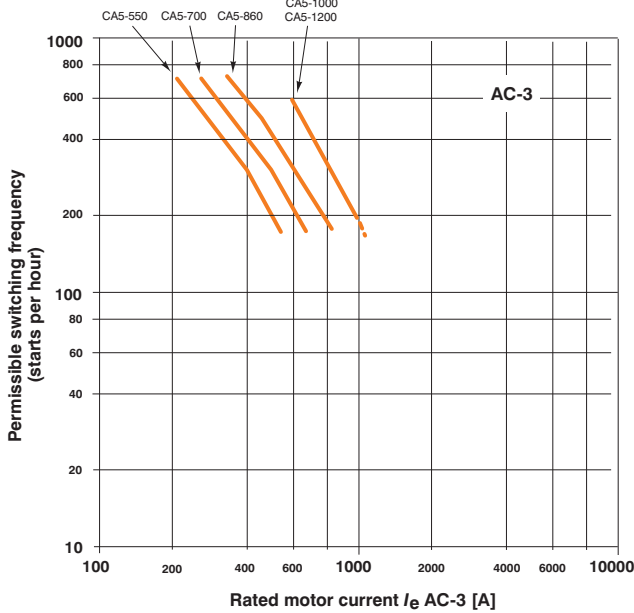

Starting time $t_A = 1$ s

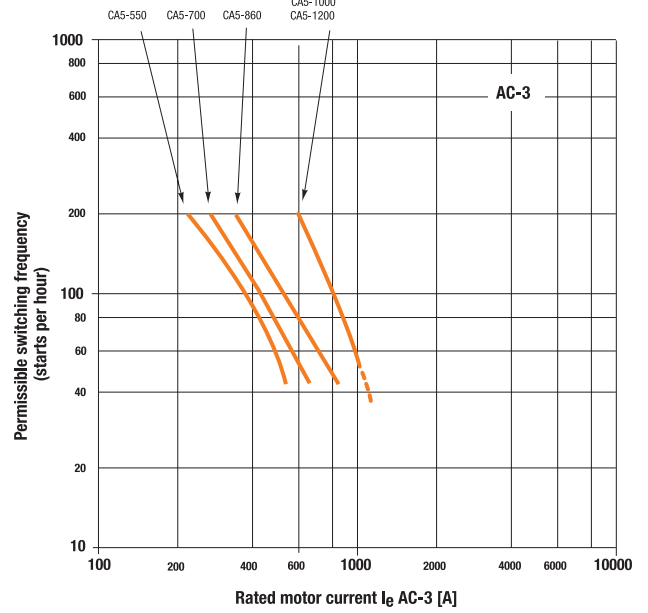

Switching motors during running (AC2, AC4)
Time energized $t_{ED} = 0.25$ s ($< t_A$)

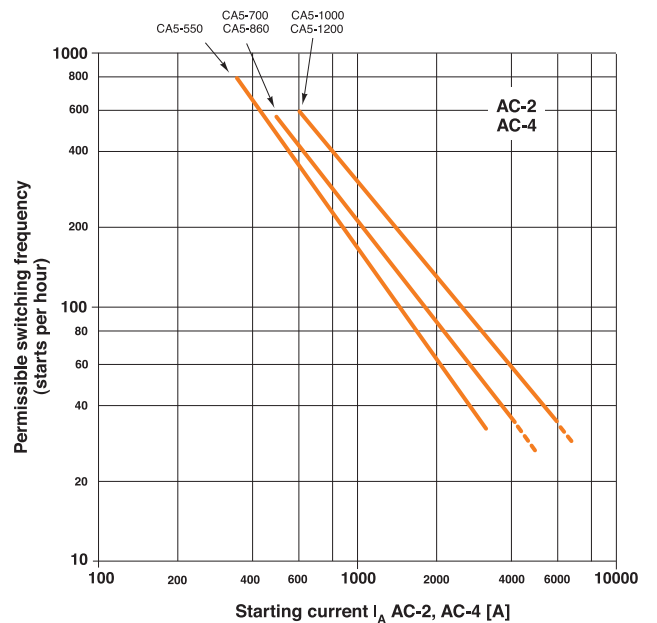

Series CA5 & Series CAU5 (Contactors & Reversing Contactors)

Dimensions are in millimeters (inches). Dimensions not intended for manufacturing purposes.

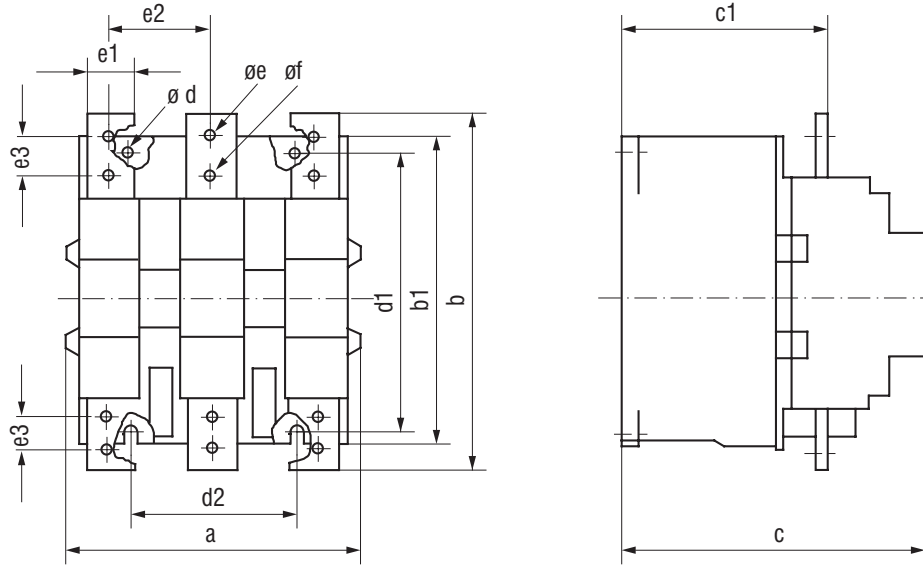

Type	a	b	b1	c	c1	ød	d1	d2	øe	øf	e1	e2	e3
CA5-550	220 (8-21/32)	258 (10-5/32)	228 (8-31/32)	225 (8-7/8)	164 (6-7/16)	9 (3/8)	220 (8-21/32)	110 (4-5/8)	13 (17/32)	-	40 (1-19/32)	79 (3-1/8)	-
CA5-700	280 (11-1/32)	307 (12-3/32)	277 (10-29/32)	291 (11-15/32)	203 (8)	11 (7/16)	280 (11-1/32)	175 (6-7/8)	13 (17/32)	-	50 (1-31/32)	101 (4)	-
CA5-860	280 (11-1/32)	361 (14-7/32)	325 (12-25/32)	291 (11-15/32)	203 (8)	11 (7/16)	280 (11-1/32)	175 (6-7/8)	15 (19/32)	11 (7/16)	50 (1-31/32)	101 (4)	32 (1-17/64)
CA5-1000	334 (13-5/32)	490 (19-9/32)	434 (17-1/16)	345 (13-9/16)	231 (9/32)	13 (25/64)	380 (14-31/32)	120 (4-23/32)	13 (25/64)	13 (25/64)	60 (2-3/8)	100 (3-31/32)	40 (1-9/16)
CA5-1200	334 (13-5/32)	490 (19-9/32)	434 (17-1/16)	345 (13-9/16)	231 (9/32)	13 (25/64)	380 (14-31/32)	120 (4-23/32)	13 (25/64)	13 (25/64)	60 (2-3/8)	100 (3-31/32)	40 (1-9/16)

Reversing Contactors & Accessories

Contactor with...	Dimension [mm]	Dimension [inches]
- auxiliary contact block	a	a
- reversing contactors with mechanical interlock		
next to each other		
CA 5-550-/CA 5-550	a+42+a	a+1-23/32+a
CA 5-700, -860/ CA 5-700, -860	a+32+a	a+1-1/4+a
CA 5-1000, -1200/ CA 5-1000, -1200	a+46+a	a+1-13/16+a
CA 5-550/CA, 5-700, -860	a+37+a	a+1-15/32+a
CA 5-700, -860/ CA 5-1000, -1200	a+73+a	a+2-7/8+a
above each other		
CA 5-550-/CA 5-550	b+56+b	b+2-3/16+b
CA 5-700, -860/ CA 5-700, -860	b+100...200+b	b+3-15/16...7-7/8+b
CA 5-1000, -1200/ CA 5-1000, -1200	b+230...280+b	b+9-1/16...11-1/32+b
CA 5-550/CA, 5-700, -860	b+100...200+b	b+3-15/16...7-7/8+b
CA 5-700, -860/ CA 5-1000, -1200	b+230...280+b	b+9-1/16...11-1/32+b
four main contacts		
CA 5-550-/CA 5-700, -860	a+68	a+2-11/16
CA 5-1000, -1200	a+76	a+3
latch		
CA 5-550	b+47	b+1-7/8
CA 5-700	b+64	b+2-17/32
CA 5-860	b+37	b+1-15/32
CA 5-1000, -1200	a+30	a+1-3/16

Mounting Position

